



SUSPENSION & STEERING
2018

I. Car Manufacturers:

AUDI.....	1 - 7
BMW.....	8 - 16
CHEVROLET.....	17 - 17
CHRYSLER.....	18 - 18
CITROËN.....	19 - 19
DAEWOO.....	20 - 20
DAIHATSU.....	21 - 21
FIAT.....	22 - 22
FORD.....	23 - 30
FOTON.....	31 - 31
GONOW.....	32 - 32
GWM.....	33 - 33
HONDA.....	34 - 34
HYUNDAI.....	35 - 36
ISUZU.....	37 - 37
KIA.....	38 - 38
MAZDA.....	39 - 41
MERCEDES-BENZ.....	42 - 49
MINI.....	50 - 50
MITSUBISHI.....	51 - 52
NISSAN.....	53 - 59
OPEL.....	60 - 67
PEUGEOT.....	68 - 68
PORSCHE.....	69 - 69
RENAULT.....	70 - 75
SAAB.....	76 - 76
SUBARU.....	77 - 77
SUZUKI.....	78 - 78
TOYOTA.....	79 - 84
VOLVO.....	85 - 86
VW.....	87 - 103

II. Comparison lists

ORIGINAL-NO. / GABRIEL.....	A1 - A6
GABRIEL / ORIGINAL-NO.....	B1 - B6

III. Pictures

Pictures.....	C1 - C18
---------------	----------

All data in the catalogue have been carefully checked.
No liability, however, can be accepted for any errors.
Original replacement numbers are for comparison reasons only.

Article Description			Fitting Position	Article No.
---------------------	---	---	------------------	-------------

A1 (8X1, 8XK)

05/2010 →

Control Arm-/Trailing Arm Bush	1.2 TFSI	12/2010 →; for vehicles with sports suspension	E	'E 'H	BS6417
Control Arm-/Trailing Arm Bush	1.2 TFSI, 1.4 TFSI, 1.6 TDI, 2.0 TDI, 2.0 TFSI quattro	for vehicles with off-road suspension, for vehicles with standard chassis	E	'E 'H	BS6417
Control Arm-/Trailing Arm Bush	1.6 TDI	07/2010 →; for vehicles with sports suspension	E	'E 'H	BS6417
Control Arm-/Trailing Arm Bush	1.6 TDI, 2.0 TDI	for vehicles with sports suspension	E	'E 'H	BS6417
Rod/Strut, stabiliser	1.2 TFSI, 1.4 TFSI, 1.6 TDI, 2.0 TDI, 2.0 TFSI quattro	Material: Steel	E	'E 'H	CTR5605
Top Strut Mounting	1.2 TFSI, 1.4 TFSI, 1.6 TDI, 2.0 TDI, 2.0 TFSI quattro	without ball bearing	E	'E 'H	MO6180

A1 Sportback (8XA, 8XF)

09/2011 →

Control Arm-/Trailing Arm Bush	1.2 TFSI, 1.4 TFSI, 1.6 TDI, 2.0 TDI	for vehicles with off-road suspension, for vehicles with standard chassis	E	'E 'H	BS6417
Rod/Strut, stabiliser	1.2 TFSI, 1.4 TFSI, 1.6 TDI, 2.0 TDI	Material: Steel	E	'E 'H	CTR5605
Top Strut Mounting	1.2 TFSI, 1.4 TFSI, 1.6 TDI, 2.0 TDI	without ball bearing	E	'E 'H	MO6180

A2 (8Z0)

02/2000 → 08/2005

Rod/Strut, stabiliser	1.4, 1.4 TDI, 1.6 FSI	Material: Steel	E	'E 'H	CTR5605
-----------------------	-----------------------	-----------------	---	-------	---------

A3 (8L1)

09/1996 → 05/2003

Control Arm-/Trailing Arm Bush	1.6, 1.8, 1.8 T, 1.8 T quattro, 1.9 TDI, 1.9 TDI quattro, S3 quattro		E	'E 'H	BS6417
Control Arm-/Trailing Arm Bush	1.6, 1.8, 1.8 T, 1.8 T quattro, 1.9 TDI, 1.9 TDI quattro	Material: Aluminium	E	'E	BS6883
Control Arm-/Trailing Arm Bush	1.6, 1.8, 1.8 T, 1.8 T quattro, 1.9 TDI, 1.9 TDI quattro	Material: Aluminium	E	'H	BS6884
Control Arm-/Trailing Arm Bush	1.6, 1.8, 1.8 T, 1.8 T quattro, 1.9 TDI, 1.9 TDI quattro, S3 quattro		E	'E 'H	BS6911
Repair Kit, ball joint	1.6, 1.8, 1.8 T, 1.8 T quattro, 1.9 TDI, 1.9 TDI quattro, S3 quattro		E	'E	CJ986
Repair Kit, ball joint	1.6, 1.8, 1.8 T, 1.8 T quattro, 1.9 TDI, 1.9 TDI quattro, S3 quattro		E	'H	CJ987
Tie Rod End	1.6, 1.8, 1.8 T, 1.8 T quattro, 1.9 TDI, 1.9 TDI quattro	ch.8L-W-050422→; 01/1998 →	E	'E	CTR5706L
Tie Rod End	1.6, 1.8, 1.8 T, 1.8 T quattro, 1.9 TDI, 1.9 TDI quattro	ch.8L-W-050422→; 01/1998 →	E	'H	CTR5706R
Top Strut Mounting	1.6, 1.8, 1.8 T, 1.8 T quattro, 1.9 TDI, 1.9 TDI quattro, S3 quattro	without ball bearing	E	'E 'H	MO6180
Tie Rod Axle Joint	1.6, 1.8, 1.8 T, 1.8 T quattro, 1.9 TDI, 1.9 TDI quattro	ch.8L-W-050422→; 01/1998 →	E	'E 'H	RE8143

A3 (8P1)

05/2003 → 08/2012

Control Arm-/Trailing Arm Bush	1.4 TFSI, 1.6, 1.6 FSI, 1.6 TDI, 1.8 T, 1.8 TFSI, 1.8 TFSI quattro, 1.9 TDI, 2.0, 2.0 FSI, 2.0 TDI, 2.0 TDI 16V, 2.0 TDI 16V quattro, 2.0 TDI quattro, 2.0 TFSI, 2.0 TFSI quattro, 3.2 V6 quattro, S3 quattro	Material: Aluminium	E	'E	BS6883
Control Arm-/Trailing Arm Bush	1.4 TFSI, 1.6, 1.6 FSI, 1.6 TDI, 1.8 T, 1.8 TFSI, 1.8 TFSI quattro, 1.9 TDI, 2.0, 2.0 FSI, 2.0 TDI, 2.0 TDI 16V, 2.0 TDI 16V quattro, 2.0 TDI quattro, 2.0 TFSI, 2.0 TFSI quattro, 3.2 V6 quattro, S3 quattro	Material: Aluminium	E	'H	BS6884
Control Arm-/Trailing Arm Bush	1.2 TSI, 1.4 TFSI, 1.6, 1.6 E-Power, 1.6 FSI, 1.6 TDI, 1.8 T, 1.8 TFSI, 1.8 TFSI quattro, 1.9 TDI, 2.0, 2.0 FSI, 2.0 TDI, 2.0 TDI 16V, 2.0 TDI 16V quattro, 2.0 TDI quattro, 2.0 TFSI, 2.0 TFSI quattro, 3.2 V6 quattro, S3 quattro	Rubber-metal Bearing	E	'E 'H	BS6899
Rod/Strut, stabiliser	1.2 TSI, 1.4 TFSI, 1.6, 1.6 E-Power, 1.6 FSI, 1.6 TDI, 1.8 T, 1.8 TFSI, 1.8 TFSI quattro, 1.9 TDI, 2.0, 2.0 FSI, 2.0 TDI, 2.0 TDI 16V, 2.0 TDI 16V quattro, 2.0 TDI quattro, 2.0 TFSI quattro, 3.2 V6 quattro, S3 quattro	Material: Steel	E	'E 'H	CTR5849

						
BS6417	BS6883	BS6884	BS6899	BS6911	CJ986	CJ987
Ref.Nr.: 1J0407181	Ref.Nr.: 1K0199231J	Ref.Nr.: 1K0199232J	Ref.Nr.: 1K0407182	Ref.Nr.: 191407182	Ref.Nr.: 1J0407365A	Ref.Nr.: 1J0407366H
						
CTR5605	CTR5706L	CTR5706R	CTR5849	MO6180	RE8143	
Ref.Nr.: 6Q0411315E	Ref.Nr.: 1J0422811B	Ref.Nr.: 1J0422812B	Ref.Nr.: 1K0411315G	Ref.Nr.: 1J0412331B	Ref.Nr.: 1J0422807B	

Article Description			Fitting Position	Article No.
---------------------	---	---	------------------	-------------

A3 (8P1)

05/2003 → 08/2012

Rod/Strut, stabiliser	2.0 TFSI	Engine Code: AXX; Material: Steel	E	'E	'H	CTR5849
Tie Rod Axle Joint	1.2 TFSI, 1.4 TFSI, 1.6, 1.6 FSI, 1.6E-Power, 1.6 TDI, 1.8 T, 1.8 TFSI, 1.8 TFSI quattro, 1.9 TDI, 2.0, 2.0 FSI, 2.0 TDI, 2.0 TDI 16V, 2.0 TDI 16V quattro, 2.0 TDI quattro, 2.0 TFSI, 2.0 TFSI quattro, 3.2 V6 quattro, S3 quattro		E	'E	'H	RE5841

A3 Convertible (8P7)

04/2008 → 05/2013

Control Arm-/Trailing Arm Bush	1.6, 1.6 TDI, 1.8 TFSI, 1.9 TDI, 2.0 TDI, 2.0 TFSI	Material: Aluminium	E	'E		BS6883
Control Arm-/Trailing Arm Bush	1.6, 1.6 TDI, 1.8 TFSI, 1.9 TDI, 2.0 TDI, 2.0 TFSI	Material: Aluminium	E		'H	BS6884
Control Arm-/Trailing Arm Bush	1.2 TFSI, 1.4 TFSI, 1.6, 1.6 TDI, 1.8 TFSI, 1.9 TDI, 2.0 TDI, 2.0 TFSI	Rubber-metal Bearing	E	'E	'H	BS6899
Rod/Strut, stabiliser	1.2 TFSI, 1.6, 1.6 TDI, 1.8 TFSI, 1.9 TDI, 2.0 TDI, 2.0 TFSI	Material: Steel	E	'E	'H	CTR5849
Tie Rod Axle Joint	1.2 TFSI, 1.4 TFSI, 1.6, 1.6 TDI, 1.8 TFSI, 1.9 TDI, 2.0 TDI, 2.0 TFSI	for vehicles with electric power steering	E	'E	'H	RE5841

A3 Sportback (8PA)

09/2004 → 03/2013

Control Arm-/Trailing Arm Bush	1.4 TFSI, 1.6, 1.6 FSI, 1.6 TDI, 1.8 TFSI, 1.8 TFSI quattro, 1.9 TDI, 2.0, 2.0 FSI, 2.0 TDI, 2.0 TDI 16V, 2.0 TDI 16V quattro, 2.0 TDI quattro, 2.0 TFSI, 2.0 TFSI quattro, 3.2 V6	Material: Aluminium	E	'E		BS6883
Control Arm-/Trailing Arm Bush	1.4 TFSI, 1.6, 1.6 FSI, 1.6 TDI, 1.8 TFSI, 1.8 TFSI quattro, 1.9 TDI, 2.0, 2.0 FSI, 2.0 TDI, 2.0 TDI 16V, 2.0 TDI 16V quattro, 2.0 TDI quattro, 2.0 TFSI, 2.0 TFSI quattro, 3.2 V6	Material: Aluminium	E		'H	BS6884
Control Arm-/Trailing Arm Bush	1.2 TFSI, 1.4 TFSI, 1.6, 1.6E-Power, 1.6 FSI, 1.6 TDI, 1.8 TFSI, 1.8 TFSI quattro, 1.9 TDI, 2.0, 2.0 FSI, 2.0 TDI, 2.0 TDI 16V, 2.0 TDI 16V quattro, 2.0 TDI quattro, 2.0 TFSI, 2.0 TFSI quattro, 3.2 V6 quattro, RS3 quattro, S3 quattro	Rubber-metal Bearing	E	'E	'H	BS6899
Rod/Strut, stabiliser	1.2 TFSI, 1.4 TFSI, 1.6, 1.6E-Power, 1.6 TDI, 1.8 TFSI, 1.8 TFSI quattro, 1.9 TDI, 2.0, 2.0 TDI, 2.0 TDI 16V, 2.0 TDI 16V quattro, 2.0 TDI quattro, 2.0 TFSI quattro, S3 quattro	Material: Steel	E	'E	'H	CTR5849
Rod/Strut, stabiliser	1.6 FSI	Engine Code: BLP; Material: Steel	E	'E	'H	CTR5849
Rod/Strut, stabiliser	2.0 FSI	Engine Code: BLR, BLX, BLY, BVY, BVZ; Material: Steel	E	'E	'H	CTR5849
Rod/Strut, stabiliser	2.0 TFSI	Engine Code: AXX; Material: Steel	E	'E	'H	CTR5849
Rod/Strut, stabiliser	3.2 V6 quattro	Engine Code: BMJ; Material: Steel	E	'E	'H	CTR5849
Tie Rod Axle Joint	1.2 TFSI, 1.4 TFSI, 1.6E-Power, 1.6 TDI, 1.6, 1.6 FSI, 1.8 TFSI, 1.8 TFSI quattro, 1.9 TDI, 2.0, 2.0 FSI, 2.0 TDI, 2.0 TDI 16V, 2.0 TDI 16V quattro, 2.0 TDI quattro, 2.0 TFSI, 2.0 TFSI quattro, 3.2 V6 quattro, RS3 quattro, S3 quattro		E	'E	'H	RE5841

A3 (8V1, 8VK)

04/2012 →

Tie Rod Axle Joint	1.4 TFSI, 1.6 TDI, 1.8 TFSI, 1.8 TFSI quattro, 2.0 TDI, 2.0 TDI quattro		E	'E	'H	RE5841
--------------------	---	--	---	----	----	--------

A4 (8D2, B5)

11/1994 → 09/2001

Control Arm-/Trailing Arm Bush	1.6, 1.8, 1.8 quattro, 1.8 T, 1.8 T quattro, 1.9 TDI, 1.9 TDI quattro, 2.4, 2.4 quattro, 2.5 TDI, 2.5 TDI quattro, 2.6, 2.6 quattro, 2.8, 2.8 quattro, S4 quattro	Rubber-metal Bearing	E	'E	'H	BS7069
Control Arm-/Trailing Arm Bush	1.6, 1.8, 1.8 quattro, 1.8 T, 1.8 T quattro, 1.9 TDI, 1.9 TDI quattro, 2.4, 2.4 quattro, 2.5 TDI, 2.5 TDI quattro, 2.6, 2.6 quattro, 2.8, 2.8 quattro, S4 quattro		E	'E	'H	BS7072
Track Control Arm	1.6, 1.8, 1.8 quattro, 1.8 T, 1.8 T quattro, 1.9 TDI, 1.9 TDI quattro, 2.4, 2.4 quattro, 2.5 TDI, 2.5 TDI quattro, 2.6, 2.6 quattro, 2.8, 2.8 quattro, S4 quattro		E		'H	CJ1033

						
BS6883	BS6884	BS6899	BS7069	BS7072	CJ1033	CTR5849
Ref.Nr.: 1K0199231J	Ref.Nr.: 1K0199232J	Ref.Nr.: 1K0407182	Ref.Nr.: 4D0407183P	Ref.Nr.: 4D0407515	Ref.Nr.: 8D0407506H	Ref.Nr.: 1K0411315G
						
RE5841						
Ref.Nr.: 1K0423810A						

Article Description			Fitting Position	Article No.
---------------------	---	---	------------------	-------------

A4 (8D2, B5)











11/1994 → 09/2001

Track Control Arm	1.6, 1.8, 1.8 quattro, 1.8 T, 1.8 T quattro, 1.9 TDI, 1.9 TDI quattro, 2.4, 2.4 quattro, 2.5 TDI, 2.5 TDI quattro, 2.6, 2.6 quattro, 2.8, 2.8 quattro, S4 quattro		E	'E		CJ1034
Track Control Arm	1.6, 1.8, 1.8 quattro, 1.8 T, 1.8 T quattro, 1.9 TDI, 1.9 TDI quattro, 2.4, 2.4 quattro, 2.5 TDI, 2.5 TDI quattro, 2.6, 2.6 quattro, 2.8, 2.8 quattro, S4 quattro	ch.→8DV152087	E		'H	CJ1035
Track Control Arm	2.4		E	'E	'H	CJ1175
Track Control Arm	1.6, 1.8 quattro, 1.8 T, 1.8 T quattro, 1.9 TDI, 1.9 TDI quattro, 2.4, 2.4 quattro, 2.5 TDI, 2.5 TDI quattro, 2.6, 2.6 quattro, 2.8, 2.8 quattro, S4 quattro	for OE: 8D0407505B	E	'E		CJ287
Track Control Arm	1.8, 1.8 quattro, 2.4, 2.4 quattro		E	'E		CJ287
Track Control Arm	1.6, 1.8, 1.8 quattro, 1.8 T, 1.8 T quattro, 1.9 TDI, 1.9 TDI quattro, 2.4, 2.4 quattro, 2.5 TDI, 2.5 TDI quattro, 2.6, 2.6 quattro, 2.7 Bi Turbo quattro, 2.7 Turbo quattro, 2.8, 2.8 24V, 2.8 quattro, S4 quattro		E	'E		CJ292
Track Control Arm	1.6, 1.8, 1.8 quattro, 1.8 T, 1.8 T quattro, 1.9 TDI, 1.9 TDI quattro, 2.4, 2.4 quattro, 2.5 TDI, 2.5 TDI quattro, 2.6, 2.6 quattro, 2.7 Bi Turbo quattro, 2.7 Turbo quattro, 2.8, 2.8 24V, 2.8 quattro, S4 quattro		E		'H	CJ293
Tie Rod End	1.6, 1.8, 1.8 quattro, 1.8 T, 1.8 T quattro, 1.9 TDI, 1.9 TDI quattro, 2.4, 2.4 quattro, 2.5 TDI, 2.5 TDI quattro, 2.6, 2.6 quattro, 2.7 Bi Turbo quattro, 2.7 Turbo quattro, 2.8, 2.8 24V, 2.8 quattro	ch.→8D-X-303809; → 05/1999; for left-hand drive vehicles; with screw	E	'E	'H	CTR5491
Tie Rod End	1.6, 1.8, 1.8 quattro, 1.8 T, 1.8 T quattro, 1.9 TDI, 1.9 TDI quattro, 2.4, 2.4 quattro, 2.5 TDI, 2.5 TDI quattro, 2.6, 2.6 quattro, 2.7 Bi Turbo quattro, 2.7 Turbo quattro, 2.8, 2.8 24V, 2.8 quattro	ch.→8D-Y-005048; → 07/1999; for right-hand drive vehicles; with screw	E	'E	'H	CTR5491
Tie Rod End	1.6, 1.8, 1.8 quattro, 1.8 T, 1.8 T quattro, 1.9 TDI, 1.9 TDI quattro, 2.4, 2.4 quattro, 2.5 TDI, 2.5 TDI quattro, 2.6, 2.6 quattro, 2.7 Bi Turbo quattro, 2.7 Turbo quattro, 2.8, 2.8 24V, 2.8 quattro	ch.8D-X-303810→; 05/1999 →; for left-hand drive vehicles; not for equipment variant: S-LINE; not for PR: 1BV; with screw; for vehicles without lowered chassis	E	'E	'H	CTR5491
Tie Rod End	1.6, 1.8, 1.8 quattro, 1.8 T, 1.8 T quattro, 1.9 TDI, 1.9 TDI quattro, 2.4, 2.4 quattro, 2.5 TDI, 2.5 TDI quattro, 2.6, 2.6 quattro, 2.7 Bi Turbo quattro, 2.7 Turbo quattro, 2.8, 2.8 24V, 2.8 quattro	ch.8D-Y-005049→; 07/1999 →; for right-hand drive vehicles; not for equipment variant: S-LINE; not for PR: 1BV; with screw; for vehicles without lowered chassis	E	'E	'H	CTR5491
Tie Rod End	1.6, 1.8, 1.9 TDI, 1.9 TDI quattro	not for equipment variant: S-LINE; not for PR: 1BV; with screw; for vehicles without lowered chassis	E	'E	'H	CTR5491
Tie Rod End	1.8 T quattro [AJL]	ch.→8D-X-199999; → 12/1998; with screw	E	'E	'H	CTR5491

A4 Avant (8D5, B5)

11/1994 → 09/2001

Control Arm-/Trailing Arm Bush	1.6, 1.8, 1.8 quattro, 1.8 T, 1.8 T quattro, 1.9 TDI, 1.9 TDI quattro, 2.4, 2.4 quattro, 2.5 TDI, 2.5 TDI quattro, 2.6, 2.6 quattro, 2.8, 2.8 quattro, S4 quattro	Rubber-metal Bearing	E	'E	'H	BS7069
Control Arm-/Trailing Arm Bush	1.6, 1.8, 1.8 quattro, 1.8 T, 1.8 T quattro, 1.9 DUO, 1.9 TDI, 1.9 TDI quattro, 2.4, 2.4 quattro, 2.5 TDI, 2.5 TDI quattro, 2.6, 2.6 quattro, 2.8, 2.8 quattro, RS4 quattro, S4 quattro		E	'E	'H	BS7072
Track Control Arm	1.6, 1.8, 1.8 quattro, 1.8 T, 1.8 T quattro, 1.9 DUO, 1.9 TDI, 1.9 TDI quattro, 2.4, 2.4 quattro, 2.5 TDI, 2.5 TDI quattro, 2.6, 2.6 quattro, 2.8, 2.8 quattro, RS4 quattro, S4 quattro		E		'H	CJ1033
Track Control Arm	1.6, 1.8, 1.8 quattro, 1.8 T, 1.8 T quattro, 1.9 TDI, 1.9 TDI quattro, 2.4, 2.4 quattro, 2.5 TDI, 2.5 TDI quattro, 2.6, 2.6 quattro, 2.8, 2.8 quattro, RS4 quattro, S4 quattro		E	'E		CJ1034
Track Control Arm	1.6, 1.8, 1.8 quattro, 1.8 T, 1.8 T quattro, 1.9 TDI, 1.9 TDI quattro, 2.4, 2.4 quattro, 2.5 TDI, 2.5 TDI quattro, 2.6, 2.6 quattro, 2.8, 2.8 quattro, RS4 quattro, S4 quattro	ch.→8DV152087	E		'H	CJ1035
Track Control Arm	2.4		E	'E	'H	CJ1175

						
BS7069	BS7072	CJ1033	CJ1034	CJ1035	CJ1175	CJ287
Ref.Nr.: 4D0407183P	Ref.Nr.: 4D0407515	Ref.Nr.: 8D0407506H	Ref.Nr.: 4D0407509K	Ref.Nr.: 4D0407510B	Ref.Nr.: 8E0407151L	Ref.Nr.: 8D0407505B
						
CJ292	CJ293	CTR5491				
Ref.Nr.: 4D0407693E	Ref.Nr.: 4D0407694K	Ref.Nr.: 4B0419811B				

Article Description			Fitting Position	Article No.
---------------------	---	---	------------------	-------------

A4 Avant (8D5, B5)









11/1994 → 09/2001

Track Control Arm	1.6, 1.8, 1.8 quattro, 1.8T, 1.8T quattro, 1.9TDI, 1.9TDI quattro, 2.4, 2.4 quattro, 2.5 TDI, 2.5 TDI quattro, 2.6, 2.6 quattro, 2.8, 2.8 quattro, RS4 quattro, S4 quattro	for OE: 8D0407505B	E	E		CJ287
Track Control Arm	1.8, 1.8 quattro, 1.9 DUO, 2.4, 2.4 quattro		E	E		CJ287
Track Control Arm	1.6, 1.8, 1.8 quattro, 1.8T, 1.8T quattro, 1.9DUO, 1.9TDI, 1.9TDI quattro, 2.4, 2.4 quattro, 2.5 TDI, 2.5 TDI quattro, 2.6, 2.6 quattro, 2.8, 2.8 quattro, RS4 quattro, S4 quattro		E	E		CJ292
Track Control Arm	1.6, 1.8, 1.8 quattro, 1.8T, 1.8T quattro, 1.9DUO, 1.9TDI, 1.9TDI quattro, 2.4, 2.4 quattro, 2.5 TDI, 2.5 TDI quattro, 2.6, 2.6 quattro, 2.8, 2.8 quattro, RS4 quattro, S4 quattro		E		H	CJ293
Tie Rod End	1.6, 1.8, 1.8 quattro, 1.8T, 1.8T quattro, 1.9DUO, 1.9TDI, 1.9TDI quattro, 2.4, 2.4 quattro, 2.5 TDI, 2.5 TDI quattro, 2.6, 2.6 quattro, 2.8, 2.8 quattro	ch.→8D-X-303809; → 05/1999; for left-hand drive vehicles; with screw	E	E	H	CTR5491
Tie Rod End	1.6, 1.8, 1.8 quattro, 1.8T, 1.8T quattro, 1.9DUO, 1.9TDI, 1.9TDI quattro, 2.4, 2.4 quattro, 2.5 TDI, 2.5 TDI quattro, 2.6, 2.6 quattro, 2.8, 2.8 quattro	ch.→8D-Y-005048; → 07/1999; for right-hand drive vehicles; with screw	E	E	H	CTR5491
Tie Rod End	1.6, 1.8, 1.8 quattro, 1.8T, 1.8T quattro, 1.9DUO, 1.9TDI, 1.9TDI quattro, 2.4, 2.4 quattro, 2.5 TDI, 2.5 TDI quattro, 2.6, 2.6 quattro, 2.8, 2.8 quattro	ch.8D-X-303810→; 05/1999 →; for left-hand drive vehicles; not for equipment variant: S-LINE; not for PR: 1BV; with screw; for vehicles without lowered chassis	E	E	H	CTR5491
Tie Rod End	1.6, 1.8, 1.8 quattro, 1.8T, 1.8T quattro, 1.9DUO, 1.9TDI, 1.9TDI quattro, 2.4, 2.4 quattro, 2.5 TDI, 2.5 TDI quattro, 2.6, 2.6 quattro, 2.8, 2.8 quattro	ch.8D-Y-005049→; 07/1999 →; for right-hand drive vehicles; not for equipment variant: S-LINE; not for PR: 1BV; with screw; for vehicles without lowered chassis	E	E	H	CTR5491
Tie Rod End	1.6, 1.9 TDI, 1.9 TDI quattro	not for equipment variant: S-LINE; not for PR: 1BV; with screw; for vehicles without lowered chassis	E	E	H	CTR5491
Tie Rod End	1.8 T quattro [AJL]	ch.→8D-X-199999; → 12/1998; with screw	E	E	H	CTR5491

A4 (8E2, B6)

11/2000 → 12/2004

Control Arm-/Trailing Arm Bush	1.8T, 1.8T quattro, 1.9TDI, 2.0, 2.5 TDI quattro, 3.0, 3.0 quattro		E	E	H	BS7072
Track Control Arm	1.8T, 1.8T quattro, 1.9TDI, 2.0, 2.5 TDI quattro, 3.0, 3.0 quattro		E		H	CJ1033
Track Control Arm	1.6, 1.8T, 1.8 T quattro, 1.9 TDI, 2.0, 2.5 TDI quattro, 3.0, 3.0 quattro		E	E		CJ1034
Track Control Arm	1.6, 1.8T, 1.8 T quattro, 1.9 TDI, 2.0, 2.5 TDI quattro, 3.0, 3.0 quattro		E		H	CJ1035
Track Control Arm	1.6, 1.8T, 1.8 T quattro, 1.9 TDI, 1.9 TDI quattro, 2.0, 2.0 FSI, 2.4, 2.5 TDI, 2.5 TDI quattro, 3.0, 3.0 quattro, S4 quattro		E	E	H	CJ1175
Track Control Arm	1.8T, 1.8T quattro, 1.9TDI, 2.0, 2.5 TDI quattro, 3.0, 3.0 quattro		E	E		CJ287
Track Control Arm	1.6, 1.8T, 1.8 T quattro, 1.9 TDI, 1.9 TDI quattro, 2.0, 2.0 FSI, 2.4, 2.5 TDI, 2.5 TDI quattro, 3.0, 3.0 quattro		E	E		CJ292
Track Control Arm	1.6, 1.8T, 1.8 T quattro, 1.9 TDI, 1.9 TDI quattro, 2.0, 2.0 FSI, 2.4, 2.5 TDI, 2.5 TDI quattro, 3.0, 3.0 quattro		E		H	CJ293
Tie Rod End	1.6, 1.8T, 1.8 T quattro, 1.9 TDI, 1.9 TDI quattro, 2.0, 2.0 FSI, 2.4, 2.5 TDI, 2.5 TDI quattro, 3.0, 3.0 quattro	for PR: 1BA; with screw; for vehicles with standard chassis	E	E	H	CTR5491
Tie Rod End	1.6, 1.8T, 1.8 T quattro, 1.9 TDI, 1.9 TDI quattro, 2.0, 2.0 FSI, 2.4, 2.5 TDI, 2.5 TDI quattro, 3.0, 3.0 quattro	for PR: 1BD; with screw; for vehicles with lowered chassis, for vehicles with sports suspension	E	E	H	CTR5491
Tie Rod End	1.6, 1.8T, 1.8 T quattro, 1.9 TDI, 1.9 TDI quattro, 2.0, 2.0 FSI, 2.4, 2.5 TDI, 2.5 TDI quattro, 3.0, 3.0 quattro	for PR: 1BE; with screw; for vehicles with lowered chassis, for vehicles with sports suspension	E	E	H	CTR5491
Tie Rod End	1.6, 1.8T, 1.8 T quattro, 1.9 TDI, 1.9 TDI quattro, 2.0, 2.0 FSI, 2.4, 2.5 TDI, 2.5 TDI quattro, 3.0, 3.0 quattro	for PR: 1BR; with screw; for vehicles with comfort suspension, for vehicles with off-road suspension	E	E	H	CTR5491
Tie Rod End	1.6, 1.8T, 1.8 T quattro, 1.9 TDI, 1.9 TDI quattro, 2.0, 2.0 FSI, 2.4, 2.5 TDI, 2.5 TDI quattro, 3.0, 3.0 quattro	not for equipment variant: S-LINE; not for PR: 1BV; with screw; for vehicles without lowered chassis, for vehicles without sports suspension	E	E	H	CTR5491

						
BS7072	CJ1033	CJ1034	CJ1035	CJ1175	CJ287	CJ292
Ref.Nr.: 4D0407515	Ref.Nr.: 8D0407506H	Ref.Nr.: 4D0407509K	Ref.Nr.: 4D0407510B	Ref.Nr.: 8E0407151L	Ref.Nr.: 8D0407505B	Ref.Nr.: 4D0407693E
						
CJ293	CTR5491					
Ref.Nr.: 4D0407694K	Ref.Nr.: 4B0419811B					

Article Description			Fitting Position	Article No.
---------------------	---	---	------------------	-------------

A4 Avant (8E5, B6)

10/2000 → 12/2004

Track Control Arm	1.6, 1.8 T, 1.8 T quattro, 1.9 TDI, 1.9 TDI quattro, 2.0, 2.0 FSI, 2.4, 2.5 TDI, 2.5 TDI quattro, 3.0, 3.0 quattro, S4 quattro		E	'E 'H	CJ1175
Track Control Arm	1.6, 1.8 T, 1.8 T quattro, 1.9 TDI, 1.9 TDI quattro, 2.0, 2.0 FSI, 2.4, 2.5 TDi, 2.5 TDI quattro, 3.0, 3.0 quattro		E	'E	CJ292
Track Control Arm	1.6, 1.8 T, 1.8 T quattro, 1.9 TDI, 1.9 TDI quattro, 2.0, 2.0 FSI, 2.4, 2.5 TDi, 2.5 TDI quattro, 3.0, 3.0 quattro		E	'H	CJ293
Tie Rod End	1.6, 1.8 T, 1.8 T quattro, 1.9 TDI, 1.9 TDI quattro, 2.0, 2.0 FSI, 2.4, 2.5 TDI, 2.5 TDI quattro, 3.0, 3.0 quattro	for PR: 1BA; with screw; for vehicles with standard chassis	E	'E 'H	CTR5491
Tie Rod End	1.6, 1.8 T, 1.8 T quattro, 1.9 TDI, 1.9 TDI quattro, 2.0, 2.0 FSI, 2.4, 2.5 TDI, 2.5 TDI quattro, 3.0, 3.0 quattro	for PR: 1BD; with screw; for vehicles with lowered chassis, for vehicles with sports suspension	E	'E 'H	CTR5491
Tie Rod End	1.6, 1.8 T, 1.8 T quattro, 1.9 TDI, 1.9 TDI quattro, 2.0, 2.0 FSI, 2.4, 2.5 TDI, 2.5 TDI quattro, 3.0, 3.0 quattro	for PR: 1BE; with screw; for vehicles with lowered chassis, for vehicles with sports suspension	E	'E 'H	CTR5491
Tie Rod End	1.6, 1.8 T, 1.8 T quattro, 1.9 TDI, 1.9 TDI quattro, 2.0, 2.0 FSI, 2.4, 2.5 TDI, 2.5 TDI quattro, 3.0, 3.0 quattro	for PR: 1BR; with screw; for vehicles with comfort suspension, for vehicles with off-road suspension	E	'E 'H	CTR5491
Tie Rod End	1.6, 1.8 T, 1.8 T quattro, 1.9 TDI, 1.9 TDI quattro, 2.0, 2.0 FSI, 2.4, 2.5 TDI, 2.5 TDI quattro, 3.0, 3.0 quattro	not for equipment variant: S-LINE; not for PR: 1BV; with screw; for vehicles without lowered chassis, for vehicles without sports suspension	E	'E 'H	CTR5491

A4 (8EC, B7)

11/2004 → 06/2008

Track Control Arm	1.8 T, 1.8 T quattro, 2.0 TDI, 2.0 TDI 16V		E	'E 'H	CJ1175
-------------------	--	--	---	-------	--------

A4 Avant (8ED, B7)

11/2004 → 06/2008

Track Control Arm	1.8 T, 1.8 T quattro, 2.0 TDI, 2.0 TDI 16V		E	'E 'H	CJ1175
-------------------	--	--	---	-------	--------

A4 Convertible (8H7, B6, 8HE, B7)









04/2002 → 03/2009

Track Control Arm	1.8 T, 1.8 T quattro, 2.0, 2.4, 2.5 TDI, 3.0, 3.0 quattro, S4 quattro		E	'E 'H	CJ1175
Track Control Arm	1.8, 1.8 T, 1.8 T quattro, 2.0, 2.0 TFSi quattro, 2.4, 2.5 TDI, 3.0, 3.0 quattro	ch.→8H-6-025 000; → 12/2005	E	'E	CJ292
Track Control Arm	S4 quattro	ch.→8H-6-905 000; → 12/2005	E	'E	CJ292
Track Control Arm	1.8, 1.8 T, 1.8 T quattro, 2.0, 2.0 TFSi quattro, 2.4, 2.5 TDI, 3.0, 3.0 quattro	ch.→8H-6-025 000; → 12/2005	E	'H	CJ293
Track Control Arm	S4 quattro	ch.→8H-6-905 000; → 12/2005	E	'H	CJ293
Tie Rod End	1.8, 1.8 T, 1.8 T quattro, 2.0, 2.4, 2.5 TDI, 3.0, 3.0 quattro	ch.→8H-5-014476; → 11/2004; with screw	E	'E 'H	CTR5491

A6 (4B2, C5)

01/1997 → 01/2005

Control Arm-/Trailing Arm Bush	1.8, 1.8 T, 1.8 T quattro, 1.9 TDI, 2.4, 2.4 quattro, 2.5 TDI, 2.5 TDI quattro, 2.7 T quattro, 2.7 T quattro, 2.8, 2.8 quattro	Rubber-metal Bearing; 01/1998 →	E	'E 'H	BS7069
Control Arm-/Trailing Arm Bush	2.7 T	Rubber-metal Bearing	E	'E 'H	BS7069
Control Arm-/Trailing Arm Bush	1.8 T, 1.8 T quattro, 2.4, 2.4 quattro, 2.5 TDI, 2.5 TDI quattro, 2.7 T quattro, 2.8 quattro, 3.7, 3.7 quattro, 4.2 quattro, S6 quattro	for OE: 8D0407505B	E	'E 'H	BS7072
Control Arm-/Trailing Arm Bush	1.8, 1.8 T quattro, 1.9 TDI, 2.7 T, 2.8		E	'E 'H	BS7072
Control Arm-/Trailing Arm Bush	1.8, 1.8 T, 1.9 TDI, 2.4, 2.5 TDI, 2.8	01/1998 →	E	'E 'H	BS7072
Track Control Arm	1.8, 1.8 T, 1.8 T quattro, 1.9 TDI, 2.4, 2.4 quattro, 2.5 TDI, 2.5 TDI quattro, 2.7 T, 2.7 T quattro, 2.8, 2.8 quattro, 3.7, 3.7 quattro, 4.2 quattro, S6 quattro		E	'H	CJ1033
Track Control Arm	1.8, 1.8 T, 1.8 T quattro, 1.9 TDI, 2.4, 2.4 quattro, 2.5 TDI, 2.5 TDI quattro, 2.7 T, 2.7 T quattro, 2.8, 2.8 quattro, 3.7, 3.7 quattro, 4.2 quattro, S6 quattro	for OE: 8D0407505B	E	'E	CJ287

						
BS7069	BS7072	CJ1033	CJ1175	CJ287	CJ292	CJ293
Ref.Nr.: 4D0407183P	Ref.Nr.: 4D0407515	Ref.Nr.: 8D0407506H	Ref.Nr.: 8E0407151L	Ref.Nr.: 8D0407505B	Ref.Nr.: 4D0407693E	Ref.Nr.: 4D0407694K
						
CTR5491						
Ref.Nr.: 4B0419811B						

Article Description			Fitting Position	Article No.
---------------------	---	---	------------------	-------------

A6 (4B2, C5)

01/1997 → 01/2005

Track Control Arm	1.8, 1.8 T, 1.8 T quattro, 1.9 TDI, 2.0, 2.4, 2.4 quattro, 2.5 TDI, 2.5 TDI quattro, 2.7, 2.7 quattro, 2.7 T, 2.7 T quattro, 2.8, 2.8 quattro, 3.0, 3.0 quattro, 3.7, 3.7 quattro, 4.2 quattro, RS6 quattro, S6 quattro		E	E			CJ292
Track Control Arm	1.8, 1.8 T, 1.8 T quattro, 1.9 TDI, 2.0, 2.4, 2.4 quattro, 2.5 TDI, 2.5 TDI quattro, 2.7, 2.7 quattro, 2.7 T, 2.7 T quattro, 2.8, 2.8 quattro, 3.0, 3.0 quattro, 3.7, 3.7 quattro, 4.2 quattro, RS6 quattro, S6 quattro		E			H	CJ293
Tie Rod End	1.8, 1.8 T, 1.8 T quattro, 1.9 TDI, 2.4, 2.4 quattro, 2.5 TDI, 2.5 TDI quattro, 2.7 T, 2.7 T quattro, 2.8, 2.8 quattro, 3.7, 3.7 quattro, 4.2 quattro	ch.→4B-1-200000; → 04/2001; with screw	E		E	H	CTR5491

A6 Avant (4B5, C5)









12/1997 → 01/2005



Control Arm-/Trailing Arm Bush	1.8, 1.8 T, 1.8 T quattro, 1.9 TDI, 2.4, 2.4 quattro, 2.5 TDI, 2.5 TDI quattro, 2.7 T quattro, 2.8, 2.8 quattro	Rubber-metal Bearing; 01/1998 →	E		E	H	BS7069
Control Arm-/Trailing Arm Bush	2.7 T	Rubber-metal Bearing	E		E	H	BS7069
Control Arm-/Trailing Arm Bush	1.8 T quattro, 2.4 quattro, 2.5 TDI quattro, 2.7 T quattro, 2.8 quattro	ch.4B-W-180001→; 01/1998 →	E		E	H	BS7072
Control Arm-/Trailing Arm Bush	1.8 T, 1.8 T quattro, 2.4, 2.5 TDI, 2.5 TDI quattro, 3.7, 3.7 quattro, 4.2 quattro, S6 quattro	for OE: 8D0407505B	E		E	H	BS7072
Control Arm-/Trailing Arm Bush	1.8, 1.8 T, 1.9 TDI, 2.4, 2.5 TDI, 2.8	01/1998 →	E		E	H	BS7072
Control Arm-/Trailing Arm Bush	1.8, 1.9 TDI, 2.7 T, 2.8		E		E	H	BS7072
Track Control Arm	1.8, 1.8 T, 1.8 T quattro, 1.9 TDI, 2.4, 2.4 quattro, 2.5 TDI, 2.5 TDI quattro, 2.7 T, 2.7 T quattro, 2.8, 2.8 quattro, 3.7, 3.7 quattro, 4.2 quattro, S6 quattro		E			H	CJ1033
Track Control Arm	1.8, 1.8 T, 1.8 T quattro, 1.9 TDI, 2.4, 2.4 quattro, 2.5 TDI, 2.5 TDI quattro, 2.7 T, 2.7 T quattro, 2.8, 2.8 quattro, 3.7, 3.7 quattro, 4.2 quattro, S6 quattro	for OE: 8D0407505B	E		E		CJ287
Track Control Arm	1.8, 1.8 T, 1.8 T quattro, 1.9 TDI, 2.0, 2.4, 2.4 quattro, 2.5 TDI, 2.5 TDI quattro, 2.7 T, 2.7 T quattro, 2.8, 2.8 quattro, 3.0, 3.0 quattro, 3.7, 3.7 quattro, 4.2 quattro, RS6 plus quattro, RS6 quattro, S6 quattro		E		E		CJ292
Track Control Arm	1.8, 1.8 T, 1.8 T quattro, 1.9 TDI, 2.0, 2.4, 2.4 quattro, 2.5 TDI, 2.5 TDI quattro, 2.7 T, 2.7 T quattro, 2.8, 2.8 quattro, 3.0, 3.0 quattro, 3.7, 3.7 quattro, 4.2 quattro, RS6 plus quattro, RS6 quattro, S6 quattro		E			H	CJ293
Tie Rod End	1.8, 1.8 T, 1.8 T quattro, 1.9 TDI, 2.4, 2.4 quattro, 2.5 TDI, 2.5 TDI quattro, 2.7 T, 2.7 T quattro, 2.8, 2.8 quattro, 3.7, 3.7 quattro, 4.2 quattro	ch.→4B-1-200000; → 04/2001; with screw	E		E	H	CTR5491

A8 (4D2, 4D8)

03/1994 → 09/2002

Control Arm-/Trailing Arm Bush	2.5 TDI, 2.5 TDI quattro, 2.8, 2.8 quattro, 3.7, 3.7 quattro, 4.2 quattro, S 8 quattro	Rubber-metal Bearing	E		E	H	BS7069
Control Arm-/Trailing Arm Bush	2.5 TDI, 2.5 TDI quattro, 2.8, 2.8 quattro, 3.3 TDI quattro, 3.7, 3.7 quattro, 4.2 quattro, S 8 quattro	for OE: 4D0407505B	E		E	H	BS7072
Track Control Arm	2.5 TDI, 2.5 TDI quattro, 2.8, 2.8 quattro, 3.3 TDI quattro, 3.7, 3.7 quattro, 4.2 quattro, S 8 quattro		E			H	CJ1033
Track Control Arm	2.5 TDI, 2.5 TDI quattro, 2.8, 2.8 quattro, 3.3 TDI quattro, 3.7, 3.7 quattro, 4.2 quattro, 6.0 W12 quattro, S 8 quattro		E		E		CJ1034
Track Control Arm	2.5 TDI, 2.5 TDI quattro, 2.8, 2.8 quattro, 3.3 TDI quattro, 3.7, 3.7 quattro, 4.2 quattro, 6.0 W12 quattro, S 8 quattro	ch.→4D-X-004999; → 12/1998	E			H	CJ1035
Track Control Arm	2.5 TDI, 2.5 TDI quattro, 2.8, 2.8 quattro, 3.3 TDI quattro, 3.7, 3.7 quattro, 4.2 quattro, S 8 quattro	for OE: 4D0407505B	E		E		CJ287
Track Control Arm	2.5 TDI, 2.5 TDI quattro, 2.8 quattro, 3.3 TDI quattro, 3.7, 3.7 quattro, 4.2 quattro, 6.0 W12 quattro, S 8 quattro	→ 12/1998	E		E		CJ292

						
BS7069	BS7072	CJ1033	CJ1034	CJ1035	CJ287	CJ292
Ref.Nr.: 4D0407183P	Ref.Nr.: 4D0407515	Ref.Nr.: 8D0407506H	Ref.Nr.: 4D0407509K	Ref.Nr.: 4D0407510B	Ref.Nr.: 8D0407505B	Ref.Nr.: 4D0407693E
						
CJ293	CTR5491					
Ref.Nr.: 4D0407694K	Ref.Nr.: 4B0419811B					

Article Description			Fitting Position	Article No.
A8 (4D2, 4D8)				03/1994 → 09/2002
Track Control Arm	2.5 TDI, 2.5 TDI quattro, 2.8 quattro, 3.3 TDI quattro, 3.7, 3.7 quattro, 4.2 quattro, 6.0 W12 quattro, S 8 quattro	→ 12/1998	E	CJ293
Tie Rod End	2.5 TDI, 2.5 TDI quattro, 2.8, 2.8 quattro, 3.3 TDI quattro, 3.7, 3.7 quattro, 4.2 quattro, 6.0 W12 quattro, S 8 quattro	not for armoured vehicles; with screw	E 'E 'H	CTR5491
ALLROAD (4BH, C5)				05/2000 → 08/2005
Tie Rod End	2.5 TDI quattro, 2.7 quattro, 2.7 T quattro	ch.→4B-2-150000; → 06/2002; with screw	E 'E 'H	CTR5491
Q3 (8U)				06/2011 →
Control Arm-/Trailing Arm Bush	2.0 TDI, 2.0 TDI quattro, 2.0 TFSI quattro	Rubber-metal Bearing	E 'E 'H	BS6899
Rod/Strut, stabiliser	2.0 TDI, 2.0 TDI quattro, 2.0 TFSI quattro	Material: Steel	E 'E 'H	CTR5849
Tie Rod Axle Joint	2.0 TDI, 2.0 TDI quattro, 2.0 TFSI quattro	for vehicles with electric power steering	E 'E 'H	RE5841
TT (8N3)				10/1998 → 06/2006
Control Arm-/Trailing Arm Bush	1.8 T, 1.8 T quattro		E 'E 'H	BS6417
Control Arm-/Trailing Arm Bush	1.8 T, 1.8 T quattro	ch.→8N-Y-060000	E 'E 'H	BS6911
Top Strut Mounting	1.8 T, 1.8 T quattro, 3.2 VR6 quattro	without ball bearing	E 'E 'H	MO6180
TT Roadster (8N9)				10/1999 → 06/2006
Control Arm-/Trailing Arm Bush	1.8 T, 1.8 T quattro		E 'E 'H	BS6417
Control Arm-/Trailing Arm Bush	1.8 T, 1.8 T quattro	ch.→8N-Y-060000	E 'E 'H	BS6911
Top Strut Mounting	1.8 T, 1.8 T quattro, 3.2 VR6 quattro	without ball bearing	E 'E 'H	MO6180
TT (8J3)				08/2006 → 06/2014
Control Arm-/Trailing Arm Bush	1.8 TFSI, 2.0 quattro, 2.0 TDI quattro, 2.0 TFSI, 2.0 TFSI quattro, 2.5 TFSI quattro, 3.2 V6 quattro	Rubber-metal Bearing	E 'E 'H	BS6899
Rod/Strut, stabiliser	1.8 TFSI, 2.0 quattro, 2.0 TDI quattro, 2.0 TFSI, 2.0 TFSI quattro, 2.5 TFSI quattro, 3.2 V6 quattro	Material: Steel	E 'E 'H	CTR5849
TT Roadster (8J9)				03/2007 → 06/2014
Control Arm-/Trailing Arm Bush	1.8 TFSI, 2.0 quattro, 2.0 TDI quattro, 2.0 TFSI, 2.0 TFSI quattro, 2.5 TFSI quattro, 3.2 V6 quattro	Rubber-metal Bearing	E 'E 'H	BS6899
Rod/Strut, stabiliser	1.8 TFSI, 2.0 quattro, 2.0 TDI quattro, 2.0 TFSI, 2.0 TFSI quattro, 2.5 TFSI quattro, 3.2 V6 quattro	Material: Steel	E 'E 'H	CTR5849

						
BS6417	BS6899	BS6911	CJ293	CTR5491	CTR5849	MO6180
Ref.Nr.: 1J0407181	Ref.Nr.: 1K0407182	Ref.Nr.: 191407182	Ref.Nr.: 4D0407694K	Ref.Nr.: 4B0419811B	Ref.Nr.: 1K0411315G	Ref.Nr.: 1J0412331B
						
RE5841						
Ref.Nr.: 1K0423810A						

Article Description			Fitting Position	Article No.
---------------------	---	---	------------------	-------------

1 (E81)				09/2006 → 09/2012	
Track Control Arm	116 d, 116 i, 118 d, 118 i, 120 d, 120 i, 123 d, 130 i		E	'E	CJ1149
Track Control Arm	116 d, 116 i, 118 d, 118 i, 120 d, 120 i, 123 d, 130 i		E	'H	CJ1150
Rod/Strut, stabiliser	116 d, 116 i, 118 d, 118 i, 120 d, 120 i, 123 d, 130 i	Material: Steel	E	'E	CTR5875L
Rod/Strut, stabiliser	116 d, 116 i, 118 d, 118 i, 120 d, 120 i, 123 d, 130 i	Material: Steel	E	'H	CTR5875R
Tie Rod Axle Joint	116 d, 116 i, 116d, 118 d, 120 d, 123 d	for steering gear manufacturer: TRW	E	'E 'H	RE5843
Tie Rod Axle Joint	118 i, 120 i	Engine Code: N46N; for steering gear manufacturer: TRW	E	'E 'H	RE5843









1 Coupe (E82)				10/2007 → 10/2013	
Track Control Arm	118 d, 120 d, 120 i, 123 d, 125 i, 135 i		E	'E	CJ1149
Track Control Arm	118 d, 120 d, 120 i, 123 d, 125 i, 135 i		E	'H	CJ1150
Rod/Strut, stabiliser	118 d, 120 d, 120 i, 123 d, 125 i, 135 i	Material: Steel	E	'E	CTR5875L
Rod/Strut, stabiliser	118 d, 120 d, 120 i, 123 d, 125 i, 135 i	Material: Steel	E	'H	CTR5875R
Tie Rod Axle Joint	118 d, 120 d, 123 d	for steering gear manufacturer: TRW	E	'E 'H	RE5843
Tie Rod Axle Joint	120 i	Engine Code: N46N; for steering gear manufacturer: TRW	E	'E 'H	RE5843

1 (E87)				11/2003 → 01/2013	
Track Control Arm	116 d, 116 i, 118 d, 118 i, 120 d, 120 i, 123 d, 130 i		E	'E	CJ1149
Track Control Arm	116 d, 116 i, 118 d, 118 i, 120 d, 120 i, 123 d, 130 i		E	'H	CJ1150
Rod/Strut, stabiliser	116 d, 116 i, 118 d, 118 i, 120 d, 120 i, 123 d, 130 i	Material: Steel	E	'E	CTR5875L
Rod/Strut, stabiliser	116 d, 116 i, 118 d, 118 i, 120 d, 120 i, 123 d, 130 i	Material: Steel	E	'H	CTR5875R
Tie Rod Axle Joint	116 d, 116 i, 116d, 118 d, 118 i, 120 d, 120 i, 123 d	for steering gear manufacturer: TRW	E	'E 'H	RE5843

1 Convertible (E88)				03/2008 → 12/2013	
Track Control Arm	118 d, 118 i, 120 d, 120 i, 123 d, 125 i, 135 i		E	'E	CJ1149
Track Control Arm	118 d, 118 i, 120 d, 120 i, 123 d, 125 i, 135 i		E	'H	CJ1150
Rod/Strut, stabiliser	118 d, 118 i, 120 d, 120 i, 123 d, 125 i, 135 i	Material: Steel	E	'E	CTR5875L
Rod/Strut, stabiliser	118 d, 118 i, 120 d, 120 i, 123 d, 125 i, 135 i	Material: Steel	E	'H	CTR5875R
Tie Rod Axle Joint	118 d, 118i, 120 d, 120 i, 123 d	for steering gear manufacturer: TRW	E	'E 'H	RE5843

3 (E30)				09/1982 → 01/1992	
Control Arm-/Trailing Arm Bush	320 i, 320 is, 323 i	Automatic Transmission; for vehicles with air conditioning	E	'E 'H	BS5422
Control Arm-/Trailing Arm Bush	324 d, 324 td, 325 e 2.7, 325 i		E	'E 'H	BS5422
Ball Joint	316, 316i, 318i, 318is, 320i, 323i, 324 d, 324td, 325 e 2.7, 325 i, 325 i X, M3 2.3		E	'E 'H	CJ847
Ball Joint	316, 316i, 318i, 318is, 320i, 323i, 324 d, 324td, 325 e 2.7, 325 i, 325 i X, M3 2.3		E	'E 'H	CJ848
Rod/Strut, stabiliser	316, 316i, 318i, 318is, 320i, 323i, 324 d, 324td, 325 e 2.7, 325 i		E	'E 'H	CTR5159
Rod/Strut, stabiliser	M3 2.3, M3 EVO I 2.3, M3 EVO II 2.5		E	'E 'H	CTR5380
Tie Rod Axle Joint	315, 316, 316i, 318i, 318is, 320i, 323i, 324 d, 324td, 325 e 2.7, 325 i, M3 2.3, M3 EVO I 2.3, M3 EVO II 2.5	for OE: 32111127124	E	'E 'H	RE5472

3 Convertible (E30)				12/1985 → 10/1993	
Control Arm-/Trailing Arm Bush	318 i, 320 i, 325 i		E	'E 'H	BS5422

						
BS5422	CJ1149	CJ1150	CJ847	CJ848	CTR5159	CTR5380
Ref.Nr.: 31121130123	Ref.Nr.: 31122405861	Ref.Nr.: 31126769802	Ref.Nr.: 31121126254	Ref.Nr.: 31121139131	Ref.Nr.: 31351127689	Ref.Nr.: 31351124380
						
CTR5875L	CTR5875R	RE5472	RE5843			
Ref.Nr.: 31356765933	Ref.Nr.: 31356765934	Ref.Nr.: 32111127124	Ref.Nr.: 32216762244			

Article Description			Fitting Position	Article No.
---------------------	---	---	------------------	-------------

3 Convertible (E30)

12/1985 → 10/1993

Ball Joint	318 i, 320 i, 325 i, M3 2.3		E	'E 'H	CJ847
Ball Joint	318 i, 320 i, 325 i, M3 2.3		E	'E 'H	CJ848
Rod/Strut, stabiliser	318 i, 320 i, 325 i		E	'E 'H	CTR5159
Tie Rod Axle Joint	318 i, 320 i, 325 i, M3 2.3	for OE: 32111127124	E	'E 'H	RE5472

3 Touring (E30)

07/1987 → 06/1994

Control Arm-/Trailing Arm Bush	320 i	Automatic Transmission; for vehicles with air conditioning	E	'E 'H	BS5422
Control Arm-/Trailing Arm Bush	324 td, 325 i		E	'E 'H	BS5422
Ball Joint	316 i, 318 i, 320 i, 324 td, 325 i, 325 i X		E	'E 'H	CJ847
Ball Joint	316 i, 318 i, 320 i, 324 td, 325 i, 325 i X		E	'E 'H	CJ848
Rod/Strut, stabiliser	316 i, 318 i, 320 i, 324 td, 325 i		E	'E 'H	CTR5159
Tie Rod Axle Joint	316 i, 318 i, 320 i, 324 td, 325 i	for OE: 32111127124	E	'E 'H	RE5472

3 (E36)

09/1990 → 02/1998

Control Arm-/Trailing Arm Bush	316 i, 318 i, 318 is, 318 tds, 320 i, 323 i 2.5, 325 i, 325 td, 325 tds		E	'E 'H	BS5421
Ball Joint	316 i, 318 i, 318 is, 318 tds, 320 i, 323 i 2.5, 325 i, 325 td, 325 tds, 328 i, M3 3.0, M3 3.2	without holder	E	'E 'H	CJ863
Track Control Arm	316 i, 318 i, 318 is, 318 tds, 320 i, 323 i 2.5, 325 i, 325 td, 325 tds	Material: Steel; with ball joint, without rubber mounting; without holder	E	'E	CJ870L
Track Control Arm	316 i, 318 i, 318 is, 318 tds, 320 i, 323 i 2.5, 325 i, 325 td, 325 tds	Material: Steel; with ball joint, without rubber mounting; without holder	E	'H	CJ870R
Rod/Strut, stabiliser	316 i, 318 i, 318 is, 318 tds, 320 i, 323 i 2.5, 325 i, 325 td, 325 tds, 328 i	10/1991 →	E	'E 'H	CTR5159
Rod/Strut, stabiliser	316 i, 318 i, 320 i, 325 i, 325 td	→ 10/1991	E	'E 'H	CTR5380
Tie Rod Axle Joint	316 i, 318 i, 318 is, 318 tds, 320 i, 323 i 2.5, 325 i, 325 td, 325 tds, M3 3.2		E	'E 'H	RE046
Tie Rod Axle Joint	316 i [M40 B16]	for vehicles without power steering	E	'H	RE5489
Tie Rod Axle Joint	316 i [M43 B16]	with steering damper	E	'H	RE5489

3 Convertible (E36)







03/1993 → 04/1999

Control Arm-/Trailing Arm Bush	318 i, 320 i, 323 i, 325 i, 328 i		E	'E 'H	BS5421
Ball Joint	318 i, 320 i, 323 i, 325 i, 328 i, M3 3.0, M3 3.2	without holder	E	'E 'H	CJ863
Track Control Arm	318 i, 320 i, 323 i, 325 i, 328 i	Material: Steel; with ball joint, without rubber mounting; without holder	E	'E	CJ870L
Track Control Arm	318 i, 320 i, 323 i, 325 i, 328 i	Material: Steel; with ball joint, without rubber mounting; without holder	E	'H	CJ870R
Rod/Strut, stabiliser	318 i, 320 i, 323 i, 325 i, 328 i		E	'E 'H	CTR5159
Tie Rod Axle Joint	318 i, 320 i, 323 i, 325 i, 328 i, M3 3.0		E	'E 'H	RE046

3 Compact (E36)

03/1994 → 08/2000

Control Arm-/Trailing Arm Bush	316 i, 318 tds, 318 ti		E	'E 'H	BS5421
Ball Joint	316 i		E	'E 'H	CJ848
Ball Joint	316 g, 316 i, 318 tds, 318 ti, 323 ti	without holder	E	'E 'H	CJ863
Track Control Arm	316 i, 318 tds, 318 ti	Material: Steel; with ball joint, without rubber mounting; without holder	E	'E	CJ870L
Track Control Arm	316 i, 318 tds, 318 ti	Material: Steel; with ball joint, without rubber mounting; without holder	E	'H	CJ870R

						
BS5421	BS5422	CJ847	CJ848	CJ863	CJ870L	CJ870R
Ref.Nr.: 31129059288	Ref.Nr.: 31121130123	Ref.Nr.: 31121126254	Ref.Nr.: 31121139131	Ref.Nr.: 31121140398	Ref.Nr.: 31121094275	Ref.Nr.: 31121136530
						
CTR5159	CTR5380	RE046	RE5472	RE5489		
Ref.Nr.: 31351127689	Ref.Nr.: 31351124380	Ref.Nr.: 32111139315PA	Ref.Nr.: 32111127124	Ref.Nr.: 32111139318PA		

Article Description			Fitting Position	Article No.
---------------------	---	---	------------------	-------------

3 Compact (E36)

03/1994 → 08/2000

Rod/Strut, stabiliser	316 g, 316 i, 318 tds, 318 ti, 323 ti		E	'E	'H	CTR5159
Tie Rod Axle Joint	316 i, 318 tds, 318 ti		E	'E	'H	RE046

3 Coupe (E36)

03/1992 → 04/1999

Control Arm-/Trailing Arm Bush	316 i, 318 is, 320 i, 323 i, 325 i, 328 i		E	'E	'H	BS5421
Ball Joint	316 i, 318 is, 320 i, 323 i, 325 i, 328 i, M3 3.0, M3 3.2	without holder	E	'E	'H	CJ863
Track Control Arm	316 i, 318 is, 320 i, 323 i, 325 i, 328 i	Material: Steel; with ball joint, without rubber mounting; without holder	E	'E		CJ870L
Track Control Arm	316 i, 318 is, 320 i, 323 i, 325 i, 328 i	Material: Steel; with ball joint, without rubber mounting; without holder	E		'H	CJ870R
Rod/Strut, stabiliser	316 i, 318 is, 320 i, 323 i, 325 i, 328 i		E	'E	'H	CTR5159
Tie Rod Axle Joint	316 i, 318 is, 320 i, 323 i, 325 i, 328 i, M3 3.0, M3 3.2		E	'E	'H	RE046

3 Touring (E36)

01/1995 → 10/1999

Control Arm-/Trailing Arm Bush	318 i, 318 tds, 320 i, 323 i, 325 tds, 328 i		E	'E	'H	BS5421
Ball Joint	316 i, 318 i, 318 tds, 320 i, 323 i, 325 tds, 328 i	without holder	E	'E	'H	CJ863
Track Control Arm	318 i, 318 tds, 320 i, 323 i, 325 tds, 328 i	Material: Steel; with ball joint, without rubber mounting; without holder	E	'E		CJ870L
Track Control Arm	318 i, 318 tds, 320 i, 323 i, 325 tds, 328 i	Material: Steel; with ball joint, without rubber mounting; without holder	E		'H	CJ870R
Rod/Strut, stabiliser	316 i, 318 i, 318 tds, 320 i, 323 i, 325 tds, 328 i		E	'E	'H	CTR5159
Tie Rod Axle Joint	318 i, 318 tds, 320 i, 323 i, 325 tds, 328 i		E	'E	'H	RE046

3 (E46)













02/1998 → 04/2005

Holder, control arm mounting	316i, 318d, 318i, 320d, 320i, 323i, 325i, 328i, 330d, 330i	Hydro Bearing; Material: Aluminium	E	'E		BS7204
Holder, control arm mounting	316i, 318d, 318i, 320d, 320i, 323i, 325i, 328i, 330d, 330i	Hydro Bearing; Material: Aluminium	E		'H	BS7205
Track Control Arm	316i, 318d, 318i, 320d, 320i, 323i, 325i, 328i, 330d, 330i	Material: Aluminium; not for equipment variant: M Sport II, S338A; with ball joint, with fastening material, without rubber mounting; without holder; for vehicles without sports package	E		'H	CJ142
Track Control Arm	316i, 318d, 318i, 320d, 320i, 323i, 325i, 328i, 330d, 330i	Material: Aluminium; not for equipment variant: M Sport II, S338A; with ball joint, with fastening material, without rubber mounting; without holder; for vehicles without sports package	E	'E		CJ143
Rod/Strut, stabiliser	316i, 318d, 318i, 320d, 320i, 323i, 325i, 328i, 330d, 330i	Material: Steel	E	'E	'H	CTR5605
Tie Rod Axle Joint	316i, 318d, 318i, 320d, 320i, 323i, 325i, 325xi, 328i, 330d, 330i, 330xd, 330xi		E	'E	'H	RE5604

3 Convertible (E46)

04/2000 → 12/2007

Holder, control arm mounting	318 Ci, 320 Cd, 320 Ci, 323 Ci, 325 Ci, 330 Cd, 330 Ci	Hydro Bearing; Material: Aluminium	E	'E		BS7204
Holder, control arm mounting	318 Ci, 320 Cd, 320 Ci, 323 Ci, 325 Ci, 330 Cd, 330 Ci	Hydro Bearing; Material: Aluminium	E		'H	BS7205
Track Control Arm	318 Ci, 320 Cd, 320 Ci, 323 Ci, 325 Ci, 330 Cd, 330 Ci	Material: Aluminium; not for equipment variant: M Sport II, S338A; with ball joint, with fastening material, without rubber mounting; without holder; for vehicles without sports package	E		'H	CJ142
Track Control Arm	318 Ci, 320 Cd, 320 Ci, 325 Ci, 330 Cd, 330 Ci	Material: Aluminium; not for equipment variant: M Sport II, S338A; with ball joint, with fastening material, without rubber mounting; without holder; for vehicles without sports package	E	'E		CJ143
Track Control Arm	323 Ci	Material: Aluminium; with ball joint, with fastening material, without rubber mounting; without holder	E	'E		CJ143

						
BS5421	BS7204	BS7205	CJ142	CJ143	CJ863	CJ870L
Ref.Nr.: 31129059288	Ref.Nr.: 31124004359	Ref.Nr.: 31126754899	Ref.Nr.: 31126777852	Ref.Nr.: 31126752717	Ref.Nr.: 31121140398	Ref.Nr.: 31121094275
						
CJ870R	CTR5159	CTR5605	RE046	RE5604		
Ref.Nr.: 31121136530	Ref.Nr.: 31351127689	Ref.Nr.: 6Q0411315E	Ref.Nr.: 32111139315PA	Ref.Nr.: 32111096897PA		

Article Description			Fitting Position	Article No.
---------------------	---	---	------------------	-------------

3 Convertible (E46)

04/2000 → 12/2007

Rod/Strut, stabiliser	318 Ci, 320Cd, 320 Ci, 323 Ci, 325 Ci, 330 Cd, 330 Ci, M3 3.2	Material: Steel	E	'E	'H	CTR5605
Tie Rod Axle Joint	318 Ci, 320 Ci, 323 Ci, 325 Ci, 330 Ci, M3 3.2		E	'E	'H	RE5604

3 Compact (E46)

06/2001 → 02/2005

Holder, control arm mounting	316 ti, 318 td, 318 ti, 320 td, 325 ti	Hydro Bearing; Material: Aluminium	E	'E		BS7204
Holder, control arm mounting	316 ti, 318 td, 318 ti, 320 td, 325 ti	Hydro Bearing; Material: Aluminium	E		'H	BS7205
Track Control Arm	316 ti, 318 td, 318 ti, 320 td, 325 ti	Material: Aluminium; not for equipment variant: M Sport II, S338A; with ball joint, with fastening material, without rubber mounting; without holder; for vehicles without sports package	E		'H	CJ142
Track Control Arm	316 ti, 318 td, 318 ti, 320 td, 325 ti	Material: Aluminium; not for equipment variant: M Sport II, S338A; with ball joint, with fastening material, without rubber mounting; without holder; for vehicles without sports package	E	'E		CJ143
Rod/Strut, stabiliser	316 ti, 318 td, 318 ti, 320 td, 325 ti	Material: Steel	E	'E	'H	CTR5605
Tie Rod Axle Joint	316 ti, 318 ti, 320 td, 325 ti		E	'E	'H	RE5604

3 Coupe (E46)

04/1999 → 07/2006

Holder, control arm mounting	316 Ci, 318 Ci, 320 Cd, 320 Ci, 323 Ci, 325 Ci, 328 Ci, 330 Cd	Hydro Bearing; Material: Aluminium	E	'E		BS7204
Holder, control arm mounting	316 Ci, 318 Ci, 320 Cd, 320 Ci, 323 Ci, 325 Ci, 328 Ci, 330 Cd	Hydro Bearing; Material: Aluminium	E		'H	BS7205
Track Control Arm	316 Ci, 318 Ci, 320 Cd, 320 Ci, 323 Ci, 325 Ci, 328 Ci, 330 Cd, 330 Ci	Material: Aluminium; not for equipment variant: M Sport II, S338A; with ball joint, with fastening material, without rubber mounting; without holder; for vehicles without sports package	E		'H	CJ142
Track Control Arm	316 Ci, 318 Ci, 320 Cd, 320 Ci, 323 Ci, 325 Ci, 328 Ci, 330 Cd, 330 Ci	Material: Aluminium; not for equipment variant: M Sport II, S338A; with ball joint, with fastening material, without rubber mounting; without holder; for vehicles without sports package	E	'E		CJ143
Rod/Strut, stabiliser	316 Ci, 318 Ci, 320 Cd, 320 Ci, 323 Ci, 325 Ci, 328 Ci, 330 Cd, 330 Ci, M3 3.2, M3 CSL	Material: Steel	E	'E	'H	CTR5605
Tie Rod Axle Joint	316 Ci, 318 Ci, 320 Ci, 323 Ci, 325 Ci, 328 Ci, 330 xi, M3 3.2		E	'E	'H	RE5604

3 Touring (E46)









10/1999 → 02/2005



Holder, control arm mounting	316 i, 318 d, 318 i, 320 d, 320 i, 325 i, 328 i, 330 d, 330 i	Hydro Bearing; Material: Aluminium	E	'E		BS7204
Holder, control arm mounting	316 i, 318 d, 318 i, 320 d, 320 i, 325 i, 328 i, 330 d, 330 i	Hydro Bearing; Material: Aluminium	E		'H	BS7205
Track Control Arm	316 i, 318 d, 318 i, 320 d, 320 i, 325 i, 328 i, 330 d, 330 i	Material: Aluminium; not for equipment variant: M Sport II, S338A; with ball joint, with fastening material, without rubber mounting; without holder; for vehicles without sports package	E		'H	CJ142
Track Control Arm	316 i, 318 d, 318 i, 320 d, 320 i, 325 i, 328 i, 330 d, 330 i	Material: Aluminium; not for equipment variant: M Sport II, S338A; with ball joint, with fastening material, without rubber mounting; without holder; for vehicles without sports package	E	'E		CJ143
Rod/Strut, stabiliser	316 i, 318 d, 318 i, 320 d, 320 i, 325 i, 328 i, 330 d, 330 i	Material: Steel	E	'E	'H	CTR5605
Tie Rod Axle Joint	318 i, 320 d, 320 i, 325 i, 328 i, 330 d, 330 i		E	'E	'H	RE5604

3 (E90)



01/2005 → 12/2011





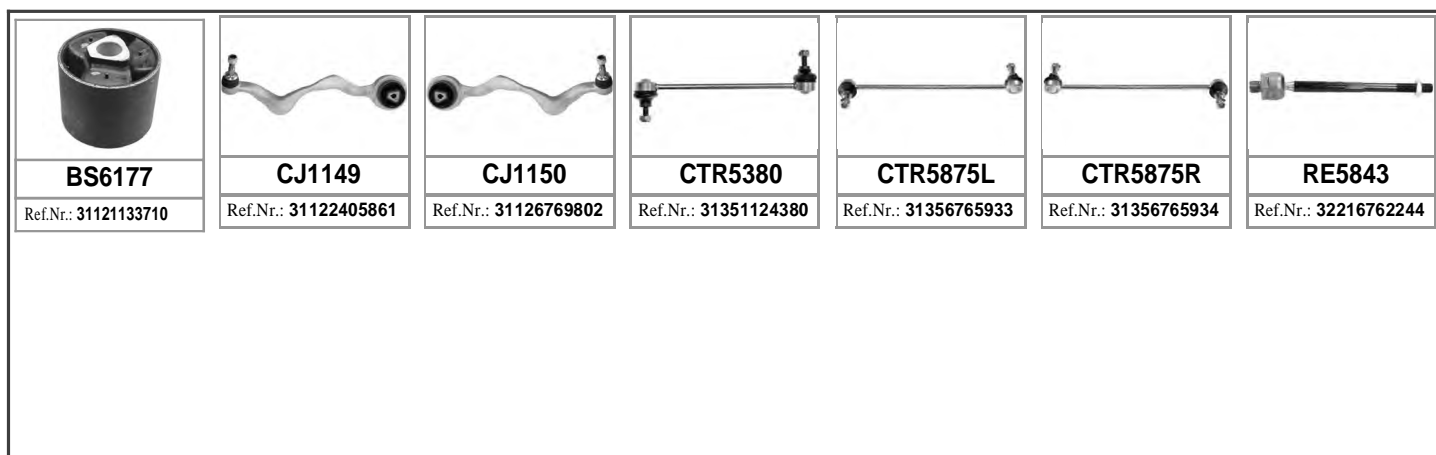





Track Control Arm	316d, 316i, 318d, 318i, 320d, 320i, 320si, 323i, 325d, 325i, 328i, 330d, 330i, 335d, 335i		E	'E		CJ1149
Track Control Arm	316d, 316i, 318d, 318i, 320d, 320i, 320si, 323i, 325d, 325i, 328i, 330d, 330i, 335d, 335i		E		'H	CJ1150
Rod/Strut, stabiliser	316d, 316i, 318d, 318i, 320d, 320i, 320si, 323i, 325d, 325i, 328i, 330d, 330i, 335d, 335i	Material: Steel	E	'E		CTR5875L



						
BS7204	BS7205	CJ1149	CJ1150	CJ142	CJ143	CTR5605
Ref.Nr.: 31124004359	Ref.Nr.: 31126754899	Ref.Nr.: 31122405861	Ref.Nr.: 31126769802	Ref.Nr.: 31126777852	Ref.Nr.: 31126752717	Ref.Nr.: 6Q0411315E
						
CTR5875L	RE5604					
Ref.Nr.: 31356765933	Ref.Nr.: 32111096897PA					















Article Description						Fitting Position	Article No.
3 (E90)							01/2005 → 12/2011
Rod/Strut, stabiliser	316 d, 316 i, 318 d, 318 i, 320 d, 320 i, 320 si, 323 i, 325 d, 325 i, 328 i, 330 d, 330 i, 335 d, 335 i	Material: Steel		E		'H	CTR5875R
Tie Rod Axle Joint	316 d, 316 i, 318 d, 318 i, 320 si	for steering gear manufacturer: TRW		E		'E 'H	RE5843
Tie Rod Axle Joint	318 i, 320 i	Engine Code: N46, N46N; for steering gear manufacturer: TRW		E		'E 'H	RE5843
Tie Rod Axle Joint	320 d	Engine Code: N47, N47N; for steering gear manufacturer: TRW		E		'E 'H	RE5843
3 Convertible (E93)							03/2007 → 12/2013
Track Control Arm	320 d, 320 i, 323 i, 325 d, 325 i, 330 d, 330 i, 335 i			E		'E	CJ1149
Track Control Arm	320 d, 320 i, 323 i, 325 d, 325 i, 330 d, 330 i, 335 i			E		'H	CJ1150
Rod/Strut, stabiliser	320 d, 320 i, 323 i, 325 d, 325 i, 330 d, 330 i, 335 i	Material: Steel		E		'E	CTR5875L
Rod/Strut, stabiliser	320 d, 320 i, 323 i, 325 d, 325 i, 330 d, 330 i, 335 i	Material: Steel		E		'H	CTR5875R
Tie Rod Axle Joint	320 d	for steering gear manufacturer: TRW		E		'E 'H	RE5843
Tie Rod Axle Joint	320 i	Engine Code: N46N; for steering gear manufacturer: TRW		E		'E 'H	RE5843
3 Coupe (E92)							06/2006 → 12/2013
Track Control Arm	320 d, 320 i, 323 i, 325 d, 325 i, 328 i, 330 d, 330 i, 335 d, 335 i			E		'E	CJ1149
Track Control Arm	320 d, 320 i, 323 i, 325 d, 325 i, 328 i, 330 d, 330 i, 335 d, 335 i			E		'H	CJ1150
Rod/Strut, stabiliser	320 d, 320 i, 323 i, 325 d, 325 i, 328 i, 330 d, 330 i, 335 d, 335 i	Material: Steel		E		'E	CTR5875L
Rod/Strut, stabiliser	320 d, 320 i, 323 i, 325 d, 325 i, 328 i, 330 d, 330 i, 335 d, 335 i	Material: Steel		E		'H	CTR5875R
Tie Rod Axle Joint	320 d	for steering gear manufacturer: TRW		E		'E 'H	RE5843
Tie Rod Axle Joint	320 i	Engine Code: N46N; for steering gear manufacturer: TRW		E		'E 'H	RE5843
3 Touring (E91)							12/2004 → 06/2012
Track Control Arm	316 i, 318 d, 318 i, 320 d, 320 i, 323 i, 325 d, 325 i, 330 d, 330 i, 335 d, 335 i			E		'E	CJ1149
Track Control Arm	316 i, 318 d, 318 i, 320 d, 320 i, 323 i, 325 d, 325 i, 330 d, 330 i, 335 d, 335 i			E		'H	CJ1150
Rod/Strut, stabiliser	316 i, 318 d, 318 i, 320 d, 320 i, 323 i, 325 d, 325 i, 330 d, 330 i, 335 d, 335 i	Material: Steel		E		'E	CTR5875L
Rod/Strut, stabiliser	316 i, 318 d, 318 i, 320 d, 320 i, 323 i, 325 d, 325 i, 330 d, 330 i, 335 d, 335 i	Material: Steel		E		'H	CTR5875R
Tie Rod Axle Joint	316 d, 320 d, 320 i	for steering gear manufacturer: TRW		E		'E 'H	RE5843
Tie Rod Axle Joint	318 i	Engine Code: N46, N46N; for steering gear manufacturer: TRW		E		'E 'H	RE5843
Tie Rod Axle Joint	320 d	Engine Code: N47, N47N; for steering gear manufacturer: TRW		E		'E 'H	RE5843
5 (E28)							06/1981 → 12/1987
Rod/Strut, stabiliser	518, 518 i, 520 i, 524 d, 524 td, 525 e, 525 i, 528 i, 535 i, M 535 i, M 3.5			E		'E 'H	CTR5380
5 (E34)							01/1988 → 09/1995
Control Arm-/Trailing Arm Bush	518 i	Rubber-metal Bearing; for OE: 31121132159, 31121132160, 31121133711, 31121133712, 31121141097, 31121141098		E		'E 'H	BS6177



Article Description			Fitting Position	Article No.
5 (E34) 01/1988 → 09/1995				
Rod/Strut, stabiliser	518 i, 520 i, 520 i 24V, 524 td, 525 i, 525 i 24V, 525 i X 24V, 525 td, 525 tds, 530 i, 530 i V8, 535 i, 540 i V8, M 3.6 CAT, M 3.8		E 'E 'H	CTR5380
5 Touring (E34) 11/1991 → 01/1997				
Control Arm-/Trailing Arm Bush	518 g, 518 i	Rubber-metal Bearing; for OE: 31121132159, 31121132160, 31121133711, 31121133712, 31121141097, 31121141098	E 'E 'H	BS6177
Rod/Strut, stabiliser	518 g, 518 i, 520 i, 525 i, 525 ix, 525 td, 525 tds, 530 i V8, 540 i, M 3.8		E 'E 'H	CTR5380
5 (E39) 11/1995 → 06/2003				
Track Control Arm	520 d, 520 i, 523 i, 525 d, 525 i, 525 td, 525 tds, 528 i, 530 d, 530 i	Material: Aluminium; with rubber mounting	E 'E	CJ1065L
Track Control Arm	520 d, 520 i, 523 i, 525 d, 525 i, 525 td, 525 tds, 528 i, 530 d, 530 i	Material: Aluminium; with rubber mounting	E 'H	CJ1065R
Track Control Arm	520 d, 520 i, 523 i, 525 d, 525 i, 525 td, 525 tds, 528 i, 530 d, 530 i	Material: Aluminium	E 'E	CJ1066L
Track Control Arm	520 d, 520 i, 523 i, 525 d, 525 i, 525 td, 525 tds, 528 i, 530 d, 530 i	Material: Aluminium	E 'H	CJ1066R
Tie Rod Axle Joint	520 d, 520 i, 523 i, 525 d, 525 i, 525 td, 525 tds, 528 i, 530 d, 530 i		E 'E 'H	RE5549
5 Touring (E39) 01/1997 → 05/2004				
Track Control Arm	520 d, 520 i, 523 i, 525 d, 525 i, 525 tds, 528 i, 530 d, 530 i	Material: Aluminium; with rubber mounting	E 'E	CJ1065L
Track Control Arm	520 d, 520 i, 523 i, 525 d, 525 i, 525 tds, 528 i, 530 d, 530 i	Material: Aluminium; with rubber mounting	E 'H	CJ1065R
Track Control Arm	520 d, 520 i, 523 i, 525 d, 525 i, 525 tds, 528 i, 530 d, 530 i	Material: Aluminium	E 'E	CJ1066L
Track Control Arm	520 d, 520 i, 523 i, 525 d, 525 i, 525 tds, 528 i, 530 d, 530 i	Material: Aluminium	E 'H	CJ1066R
Tie Rod Axle Joint	520 d, 520 i, 523 i, 525 d, 525 i, 525 tds, 528 i, 530 d, 530 i		E 'E 'H	RE5549
5 (E60) 07/2003 → 03/2010				
Track Control Arm	520 d, 520 i, 520 i, 523 i, 525 d, 525 i, 530 d, 530 i, 535 d, 540 i, 545 i, 550 i, M	Rubber-metal Bearing; Material: Aluminium; with ball joint, with rubber mounting	E 'H	CJ1151
Track Control Arm	520 d, 520 i, 520 i, 523 i, 525 d, 525 i, 530 d, 530 i, 535 d, 540 i, 545 i, 550 i, M	Rubber-metal Bearing; Material: Aluminium; with ball joint, with rubber mounting	E 'E	CJ1152
Tie Rod Axle Joint	520 d, 520 i, 523 i, 525 d, 525 i, 525 xi, 530 d, 530 i, 530 xd, 530 xi, 535 d, 540 i, 545 i, 550 i, M		E 'E 'H	RE5845
5 Touring (E61) 06/2004 → 12/2010				
Track Control Arm	520 d, 520 i, 520 i, 523 i, 525 d, 525 i, 530 d, 530 i, 535 d, 545 i, 550 i, M	Rubber-metal Bearing; Material: Aluminium; with ball joint, with rubber mounting	E 'H	CJ1151
Track Control Arm	520 d, 520 i, 520 i, 523 i, 525 d, 525 i, 530 d, 530 i, 535 d, 545 i, 550 i, M	Rubber-metal Bearing; Material: Aluminium; with ball joint, with rubber mounting	E 'E	CJ1152
Tie Rod Axle Joint	525 d, 525 i, 530 d, 530 i, 535 d, 545 i		E 'E 'H	RE5845
6 (E24) 06/1978 → 05/1989				
Rod/Strut, stabiliser	628 CSi, 635 CSi, M 635 CSi	05/1982 →	E 'E 'H	CTR5380
7 (E32) 09/1986 → 09/1994				
Rod/Strut, stabiliser	730 i, iL, 730 i, iL V8, 735 i, iL, 740 i, iL V8, 750 i, iL V12		E 'E 'H	CTR5380

						
BS6177	CJ1065L	CJ1065R	CJ1066L	CJ1066R	CJ1151	CJ1152
Ref.Nr.: 31121133710	Ref.Nr.: 31121141717	Ref.Nr.: 31121141718	Ref.Nr.: 31121093449	Ref.Nr.: 31121093450	Ref.Nr.: 31122347952	Ref.Nr.: 31122347951
						
CTR5380	RE5549	RE5845				
Ref.Nr.: 31351124380	Ref.Nr.: 32111091768*	Ref.Nr.: 32106774347PA				

Article Description			Fitting Position	Article No.
8 (E31)				04/1990 → 12/1999
Rod/Strut, stabiliser	840 Ci, 840 i, 850 Ci, 850 CSi, 850 i,Ci		E 'E 'H	CTR5380
X1 (E84)				03/2009 → 06/2015
Track Control Arm	sDrive 18 d, sDrive 18 i, sDrive 20 d, sDrive 20 i		E 'E	CJ1149
Track Control Arm	sDrive 18 d, sDrive 18 i, sDrive 20 d, sDrive 20 i		E 'H	CJ1150
Rod/Strut, stabiliser	sDrive 18 d, sDrive 18 i, sDrive 20 d, sDrive 20 i	Material: Steel	E 'E	CTR5875L
Rod/Strut, stabiliser	sDrive 18 d, sDrive 18 i, sDrive 20 d, sDrive 20 i	Material: Steel	E 'H	CTR5875R
Tie Rod Axle Joint	sDrive 18 d, sDrive 18 i, sDrive 20 d	for steering gear manufacturer: TRW	E 'E 'H	RE5843
Z1				06/1988 → 06/1991
Control Arm-/Trailing Arm Bush	2.5		E 'E 'H	BS5422
Ball Joint	2.5		E 'E 'H	CJ848
Rod/Strut, stabiliser	2.5		E 'E 'H	CTR5159
Z3 (E36)				10/1995 → 01/2003
Control Arm-/Trailing Arm Bush	1.8, 1.9, 2.0, 2.8		E 'E 'H	BS5421
Ball Joint	1.8, 1.9, 2.0, 2.2, 2.8, 3.0, M 3.2	without holder	E 'E 'H	CJ863
Track Control Arm	1.8, 1.9, 2.0	Material: Steel; with ball joint, without rubber mounting; without holder	E 'E	CJ870L
Track Control Arm	1.8, 1.9, 2.0	Material: Steel; with ball joint, without rubber mounting; without holder	E 'H	CJ870R
Rod/Strut, stabiliser	1.8, 1.9, 2.0, 2.2, 2.8, 3.0		E 'E 'H	CTR5159
Tie Rod Axle Joint	1.8, 1.9, 2.0, 2.8, M 3.2		E 'E 'H	RE046

						
BS5421	BS5422	CJ1149	CJ1150	CJ848	CJ863	CJ870L
Ref.Nr.: 31129059288	Ref.Nr.: 31121130123	Ref.Nr.: 31122405861	Ref.Nr.: 31126769802	Ref.Nr.: 31121139131	Ref.Nr.: 31121140398	Ref.Nr.: 31121094275
						
CJ870R	CTR5159	CTR5380	CTR5875L	CTR5875R	RE046	RE5843
Ref.Nr.: 31121136530	Ref.Nr.: 31351127689	Ref.Nr.: 31351124380	Ref.Nr.: 31356765933	Ref.Nr.: 31356765934	Ref.Nr.: 32111139315PA	Ref.Nr.: 32216762244

Article Description			Fitting Position	Article No.
---------------------	---	---	------------------	-------------

Z3 Coupe (E36)







07/1997 → 06/2003

Control Arm-/Trailing Arm Bush	2.8		E	'E	'H	BS5421
Ball Joint	2.8, 3.0, M	without holder	E	'E	'H	CJ863
Track Control Arm	2.8	Material: Steel; with ball joint, without rubber mounting; without holder	E	'E		CJ870L
Track Control Arm	2.8	Material: Steel; with ball joint, without rubber mounting; without holder	E		'H	CJ870R
Rod/Strut, stabiliser	2.8, 3.0		E	'E	'H	CTR5159
Tie Rod Axle Joint	2.8, M		E	'E	'H	RE046

Z4 (E85)

02/2003 → 02/2009

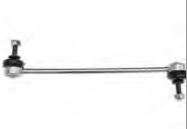
Holder, control arm mounting	2.0 i, 2.2 i, 2.5 i, 2.5 si, 3.0 i, 3.0 si, M	Hydro Bearing; Material: Aluminium	E	'E		BS7204
Holder, control arm mounting	2.0 i, 2.2 i, 2.5 i, 2.5 si, 3.0 i, 3.0 si, M	Hydro Bearing; Material: Aluminium	E		'H	BS7205
Track Control Arm	2.0 i, 2.2 i, 2.5 i, 2.5 si, 3.0 i, 3.0 si	Material: Aluminium; with ball joint, with fastening material, without rubber mounting; without holder	E		'H	CJ142
Track Control Arm	2.0 i, 2.2 i, 2.5 i, 2.5 si, 3.0 i, 3.0 si	Material: Aluminium; with ball joint, with fastening material, without rubber mounting; without holder	E	'E		CJ143
Rod/Strut, stabiliser	2.0 i, 2.2 i, 2.5 i, 2.5 si, 3.0 i, 3.0 si, M	Material: Steel	E	'E	'H	CTR5605
Tie Rod Axle Joint	2.0 i, 2.2 i, 2.5 i, 3.0 i		E	'E	'H	RE5604

						
BS5421	BS7204	BS7205	CJ142	CJ143	CJ863	CJ870L
Ref.Nr.: 31129059288	Ref.Nr.: 31124004359	Ref.Nr.: 31126754899	Ref.Nr.: 31126777852	Ref.Nr.: 31126752717	Ref.Nr.: 31121140398	Ref.Nr.: 31121094275
						
CJ870R	CTR5159	CTR5605	RE046	RE5604		
Ref.Nr.: 31121136530	Ref.Nr.: 31351127689	Ref.Nr.: 6Q0411315E	Ref.Nr.: 32111139315PA	Ref.Nr.: 32111096897PA		

Article Description			Fitting Position	Article No.
---------------------	---	---	------------------	-------------

Z4 [USA] Convertible

01/2003 → 12/2007

Rod/Strut, stabiliser	2.5 i, 3.0 24V, 3.0 si, 3.2 24V	Material: Steel	E	'E 'H	CTR5605
-----------------------	---------------------------------	-----------------	---	-------	---------

Z4 [USA] Coupe

01/2006 → 12/2009

Rod/Strut, stabiliser	3.0 si, 3.2 24V	Material: Steel	E	'E 'H	CTR5605
-----------------------	-----------------	-----------------	---	-------	---------

Z4 Coupe (E86)

03/2006 → 01/2009











Holder, control arm mounting	3.0 si, M	Hydro Bearing; Material: Aluminium	E	'E	BS7204
Holder, control arm mounting	3.0 si, M	Hydro Bearing; Material: Aluminium	E	'H	BS7205
Track Control Arm	3.0 si	Material: Aluminium; with ball joint, with fastening material, without rubber mounting; without holder	E	'H	CJ142
Track Control Arm	3.0 si	Material: Aluminium; with ball joint, with fastening material, without rubber mounting; without holder	E	'E	CJ143
Rod/Strut, stabiliser	3.0 si, M	Material: Steel	E	'E 'H	CTR5605



Z4 ROADSTER (E89)

05/2009 →

Track Control Arm	sDrive20i, sDrive23i, sDrive28i, sDrive30i, sDrive35i, sDrive35is		E	'E	CJ1149
Track Control Arm	sDrive20i, sDrive23i, sDrive28i, sDrive30i, sDrive35i, sDrive35is		E	'H	CJ1150
Rod/Strut, stabiliser	sDrive20i, sDrive23i, sDrive28i, sDrive30i, sDrive35i, sDrive35is	Material: Steel	E	'E	CTR5875L
Rod/Strut, stabiliser	sDrive20i, sDrive23i, sDrive28i, sDrive30i, sDrive35i, sDrive35is	Material: Steel	E	'H	CTR5875R



Track Control Arm	4.9	Material: Aluminium; with rubber mounting	E	'E	CJ1065L
Track Control Arm	4.9	Material: Aluminium; with rubber mounting	E	'H	CJ1065R

						
BS7204	BS7205	CJ1065L	CJ1065R	CJ1149	CJ1150	CJ142
Ref.Nr.: 31124004359	Ref.Nr.: 31126754899	Ref.Nr.: 31121141717	Ref.Nr.: 31121141718	Ref.Nr.: 31122405861	Ref.Nr.: 31126769802	Ref.Nr.: 3112677852
						
CJ143	CTR5605	CTR5875L	CTR5875R			
Ref.Nr.: 31126752717	Ref.Nr.: 6Q0411315E	Ref.Nr.: 31356765933	Ref.Nr.: 31356765934			

Article Description			Fitting Position	Article No.
AVEO Saloon (T200)			09/2003 → 12/2008	
Control Arm-/Trailing Arm Bush	1.6		E 'E 'H	BS8315
AVEO Hatchback (T250, T255)			04/2008 →	
Control Arm-/Trailing Arm Bush	1.2, 1.2 LPG, 1.4		E 'E 'H	BS8315
Track Control Arm	1.2, 1.4		E 'E	CJ269L
Track Control Arm	1.2, 1.4		E 'H	CJ269R
AVEO Saloon (T250, T255)			05/2005 → 12/2007	
Control Arm-/Trailing Arm Bush	1.2, 1.2 LPG, 1.4, 1.5, 1.6		E 'E 'H	BS8315
Track Control Arm	1.2, 1.4, 1.5		E 'E	CJ269L
Track Control Arm	1.2, 1.4, 1.5		E 'H	CJ269R
CORSA C Utility			01/2002 →	
Suspension Kit	1.4I,1.7DTI,1.8I		E 'E 'H	BS6102
Control Arm-/Trailing Arm Bush	1.4I,1.7DTI,1.8I		E 'E 'H	BS6103
Ball Joint	1.4I,1.7DTI,1.8I		E 'E 'H	CJ654
Tie Rod End	1.4I,1.7DTI,1.8I	Long	E 'E 'H	CTR5500
Rod/Strut, stabiliser	1.4I,1.7DTI,1.8I		E 'E 'H	CTR5771
Top Strut Mounting	1.4I,1.7DTI,1.8I	Shock Mounting Front	E 'E 'H	MO6848
Tie Rod Axle Joint	1.4I,1.7DTI,1.8I	285 mm P/S	E 'E 'H	RE056
Rack End	1.4I,1.7DTI,1.8I	310 mm M/S	E 'E 'H	RE1609
Tie Rod Axle Joint	1.4I,1.7DTI,1.8I	305 mm M/S	E 'E 'H	RE5499
Tie Rod Axle Joint	1.4I,1.7DTI,1.8I	280 mm M/S	E 'E 'H	RE5815

						
BS6102	BS6103	BS8315	CJ269L	CJ269R	CJ654	CTR5500
Ref.Nr.: 352309	Ref.Nr.: 24430103	Ref.Nr.: 96535088	Ref.Nr.: 96815893	Ref.Nr.: 96815894	Ref.Nr.: 9196394	Ref.Nr.: 324066
						
CTR5771	MO6848	RE056	RE1609	RE5499	RE5815	
Ref.Nr.: 90496116	Ref.Nr.: 344523	Ref.Nr.: 1603843	Ref.Nr.:	Ref.Nr.: 26087867	Ref.Nr.: 322158	

CHRYSLER

Article Description			Fitting Position	Article No.
CROSSFIRE			07/2003 → 12/2008	
Ball Joint	3.2, SRT-6		E	'E 'H CJ1028
CROSSFIRE Roadster			05/2004 → 12/2008	
Ball Joint	3.2, SRT-6		E	'E 'H CJ1028
VOYAGER Mk II (GS)			01/1995 → 03/2001	
Tie Rod End	2.0 i, 2.4 i, 2.5 TD, 3.0, 3.3 i, 3.8 i AWD		E	'E 'H CTR6107

CHRYSLER

	
CJ1028	CTR6107
Ref.Nr.: 2103330427	Ref.Nr.: 4797706

Article Description			Fitting Position	Article No.
---------------------	---	---	------------------	-------------

C4 I (LC_)

11/2004 → 07/2011

Rod/Strut, stabiliser	1.4 16V, 1.6 16V, 1.6 HDi, 2.0 16V, 2.0 HDi	Material: Steel	E	'E	'H	CTR6130
-----------------------	---	-----------------	---	----	----	---------

C4 Coupe (LA_)

11/2004 → 07/2011

Rod/Strut, stabiliser	1.4 16V, 1.6 16V, 1.6 HDi, 2.0 16V, 2.0 HDi	Material: Steel	E	'E	'H	CTR6130
-----------------------	---	-----------------	---	----	----	---------

<p>CTR6130</p>
<p>Ref.Nr.: 508750</p>

Article Description			Fitting Position	Article No.
---------------------	---	---	------------------	-------------

LANOS (KLAT)

05/1997 →

Ball Joint	1.5		E	'E	'H	CJ869
------------	-----	--	---	----	----	-------

MATIZ (KLYA)

09/1998 →

Track Control Arm	0.8		E	'E	'H	CJ1084
-------------------	-----	--	---	----	----	--------

NUBIRA (KLAJ)

05/1997 → 07/2003

Tie Rod End	1.6 16V, 2.0 16V, 2.0 CDX		E	'E	'H	CTR5141
Rod/Strut, stabiliser	1.6 16V, 2.0 16V, 2.0 CDX	01/1999 →; for OE: 96275798	E	'E	'H	CTR5891

NUBIRA Saloon (KLAJ)

05/1997 → 07/2003

Tie Rod End	1.5 SE, 1.6 16V, 2.0, 2.0 16V		E	'E	'H	CTR5141
Rod/Strut, stabiliser	1.5 SE, 1.6 16V, 2.0, 2.0 16V	01/1999 →; for OE: 96275798	E	'E	'H	CTR5891

NUBIRA Wagon (KLAJ)

05/1997 →

Tie Rod End	1.6 16V, 2.0 16V		E	'E	'H	CTR5141
Rod/Strut, stabiliser	1.6 16V, 2.0 16V	01/1999 →; for OE: 96275798	E	'E	'H	CTR5891



Article Description			Fitting Position	Article No.
---------------------	---	---	------------------	-------------



CHARADE



05/2011 →

Rod/Strut, stabiliser	1.33 16V	Material: Steel	E	E	H	CTR6161
-----------------------	----------	-----------------	---	---	---	---------

DAIHATSU

	
<p>CTR6161</p>	
<p>Ref.Nr.:</p>	

Article Description			Fitting Position	Article No.
DOBLO MPV (119_, 223_)			03/2001 →	
Ball Joint	1.2 , 1.6 16V, 1.6 Natural Power, 1.9 D , 1.9 JTD	→ 09/2002	E	'E 'H CJ1045
DOBLO Cargo (223_)			03/2001 →	
Ball Joint	1.2 , 1.6 16V , 1.9 D , 1.9 JTD	→ 09/2002	E	'E 'H CJ1045
PALIO (178BX)			04/1996 →	
Ball Joint	1.0, 1.2, 1.4, 1.4 CAT, 1.6 16V		E	'E 'H CJ1045
PALIO Weekend (178_)			02/2001 →	
Ball Joint	1.2 , 1.6 16V , 1.9 D		E	'E 'H CJ1045
STRADA Pickup (178_)			06/1999 →	
Ball Joint	1.2, 1.3 D Multijet, 1.7 TD, 1.9 D, 1.9 JTD		E	'E 'H CJ1045
UNO (146_)			01/1983 → 06/2001	
Tie Rod End	1.0, 1.0iE, 1.3 Super Diesel, 1.3 Turbo i.e., 1.4 Turbo i.e., 1.6, 1.6R, 1.9D, 450.9, 451.0, 45i.e. 1.0, 501.1, 50i.e. 1.1, 55 1.0, 55 1.1, 60 1.1, 60 Diesel 1.7, 70 1.3, 70i.e. 1.4, 70 S 1.4, 70 TD 1.4, 75 i.e. 1.5		E	'E 'H CTR5401
Top Strut Mounting	1.3 Super Diesel, 1.3 Turbo i.e., 1.9D, 450.9, 451.0, 45i.e. 1.0, 50 1.1, 55 1.1, 60 1.1, 60 Diesel 1.7, 70 1.3, 70i.e. 1.4, 70 S 1.4, 70 TD 1.4, 75 i.e. 1.5, 1.6 R	→ 10/1989	Z	'E 'H MO5809

		
CJ1045	CTR5401	MO5809
Ref.Nr.: 46543045	Ref.Nr.: 5958247	Ref.Nr.: 05960254

Article Description			Fitting Position	Article No.
---------------------	---	---	------------------	-------------

BANTAM

01/1994 → 12/2002

Ball Joint	1.3 1.6l		E	'E 'H	CJ926
Tie Rod End	1.3 1.6l		E	'E 'H	CTR5184
Tie Rod Axle Joint	1.3 1.6l	M/S	E	'E 'H	RE014

BANTAM













01/2003 →

Control Arm-/Trailing Arm Bush	1.3 XL,1.6l XLT,XLE,1.8DI XL	Control Arm Bush Rear ID 12/OD37/L62	E	'E 'H	BS6496
Control Arm-/Trailing Arm Bush	1.3 XL,1.6l XLT,XLE,1.8DI XL	Control Arm Bush FR ID12/OD66/L51	E	'E 'H	BS7411
Track Control Arm	1.3 XL,1.6l XLT,XLE,1.8DI XL	P/S	E	'E	CJ159L
Track Control Arm	1.3 XL,1.6l XLT,XLE,1.8DI XL	P/S	E	'H	CJ159R
Ball Joint	1.3 XL,1.6l XLT,XLE,1.8DI XL		E	'E 'H	CJ582
Tie Rod Axle Joint	1.3 XL,1.6l XLT,XLE,1.8DI XL	289 mm P/S	E	'E 'H	RE5571

BANTAM

01/1983 → 12/1986

Track Control Arm	1.3,1.4,1.6		E	'H	CJ843
Track Control Arm	1.3,1.4,1.6		E	'E	CJ844
Track Control Arm	1.3,1.4,1.6		E	'H	CJ964
Track Control Arm	1.3,1.4,1.6		E	'E	CJ965

						
BS6496	BS7411	CJ159L	CJ159R	CJ582	CJ843	CJ844
Ref.Nr.: 96FB3063AA	Ref.Nr.: 98FB3A262AA	Ref.Nr.: 1E0034350A	Ref.Nr.: 1003575	Ref.Nr.: 7152281	Ref.Nr.: 3246130	Ref.Nr.: 5021457
						
CJ926	CJ964	CJ965	CTR5184	RE014	RE5571	
Ref.Nr.: B00134550	Ref.Nr.: 1637182	Ref.Nr.: 1637185	Ref.Nr.: 8AB032280	Ref.Nr.: BF673224X	Ref.Nr.: 4342539	

Article Description			Fitting Position	Article No.
---------------------	---	---	------------------	-------------

B-MAX (JK)

10/2012 →

Rod/Strut, stabiliser	1.0 EcoBoost, 1.4, 1.4 LPG, 1.5 TDCi, 1.6 TDCi, 1.6 Ti	Material: Aluminium	E	'E	'H	CTR1418
Tie Rod Axle Joint	1.0 EcoBoost, 1.4, 1.4 LPG, 1.5 TDCi, 1.6 TDCi, 1.6 Ti		E	'E	'H	RE6092

B-MAX Van

10/2012 →

Rod/Strut, stabiliser	1.0 EcoBoost, 1.4, 1.5 TDCi, 1.6 TDCi, 1.6 Ti	Material: Aluminium	E	'E	'H	CTR1418
Tie Rod Axle Joint	1.0 EcoBoost, 1.4, 1.5 TDCi, 1.6 TDCi, 1.6 Ti		E	'E	'H	RE6092

C-MAX (DM2)

02/2007 → 09/2010

Ball Joint	1.6, 1.6TDCi, 1.8, 1.8Flexifuel, 1.8TDCi, 2.0, 2.0TDCi		E	'E	'H	CJ1259
Rod/Strut, stabiliser	1.6, 1.6 TDCi, 1.8, 1.8 Flexifuel, 2.0		E			CTR5923

COURIER

01/1986 → 12/1999

Ball Joint	1.6,1.8,2.0,2.2,2.5,3.0,3.4 STD XLT S/CAB,D/CAB	Upper	E	'E	'H	CJ918
Ball Joint	1.6,1.8,2.0,2.2,2.5,3.0,3.4 STD XLT S/CAB,D/CAB	Lower	E	'E	'H	CJ919
Tie Rod End	1.6,1.8,2.0,2.2,2.5,3.0,3.4 STD XLT S/CAB,D/CAB	Inner	E	'E	'H	CTR5338
Tie Rod End	1.6,1.8,2.0,2.2,2.5,3.0,3.4 STD XLT S/CAB,D/CAB	Outer	E	'E	'H	CTR5339

ECOSPORT

08/2012 →

Rod/Strut, stabiliser	1.5 TDCi, 1.5 Ti, 1.6, 2.0 4x4, EcoBoost 1.0	Material: Aluminium	E	'E	'H	CTR1418
Tie Rod Axle Joint	1.5 TDCi, 1.5 Ti, 1.6, 2.0 4x4, EcoBoost 1.0		E	'E	'H	RE6092

ESCORT CLASSIC (AAL, ABL)

10/1998 → 07/2000

Track Control Arm	1.6 16V, 1.8 TD		E		'H	CJ124
Track Control Arm	1.6 16V, 1.8 TD		E	'E		CJ125
Rod/Strut, stabiliser	1.6 16V, 1.8 TD	Material: Steel	E	'E	'H	CTR5318

FORD

						
CJ124	CJ125	CJ1259	CJ918	CJ919	CTR1418	CTR5318
Ref.Nr.: 91AB3042AD	Ref.Nr.: 95AB3051AB	Ref.Nr.: 1679388	Ref.Nr.:	Ref.Nr.: K9597	Ref.Nr.: 8V513B438AB	Ref.Nr.: YS413B438BA
						
CTR5338	CTR5339	CTR5923	RE6092			
Ref.Nr.:	Ref.Nr.:	Ref.Nr.: 3M513B438AB	Ref.Nr.: 8V513L519AA			

Article Description			Fitting Position	Article No.
---------------------	---	---	------------------	-------------

ESCORT CLASSIC Turnier (ANL)

02/1999 → 07/2000

Track Control Arm	1.6 16V, 1.8 TD		E		'H	CJ124
Track Control Arm	1.6 16V, 1.8 TD		E		'E	CJ125
Rod/Strut, stabiliser	1.6 16V, 1.8 TD	Material: Steel	E		'E 'H	CTR5318

ESCORT Mk III (GAA)

09/1980 → 07/1986

Track Control Arm	1.1, 1.3, 1.6, 1.6D, 1.6i, 1.6RS Turbo, 1.6XR3i, RS 1600i	for OE: 6087888	E		'H	CJ843
Track Control Arm	1.1, 1.3, 1.6, 1.6D, 1.6i, 1.6RS Turbo, 1.6XR3i, RS 1600i	05/1983 →	E		'E	CJ844

ESCORT Mk III Convertible (ALD)

09/1983 → 12/1985

Track Control Arm	1.3, 1.6, 1.6 i	for OE: 6087888	E		'H	CJ843
Track Control Arm	1.3, 1.6, 1.6 i		E		'E	CJ844

ESCORT Mk III Estate (AWA)

09/1980 → 12/1985

Track Control Arm	1.1, 1.3, 1.6, 1.6 D	for OE: 6087888	E		'H	CJ843
Track Control Arm	1.1, 1.3, 1.6, 1.6 D	05/1983 →	E		'E	CJ844

ESCORT Mk IV (GAF, AWF, ABFT)

10/1985 → 10/1990

Track Control Arm	1.1, 1.4	→ 12/1985; for OE: 6087888	E		'H	CJ843
Track Control Arm	1.1, 1.4		E		'E	CJ844
Track Control Arm	1.1, 1.3, 1.4, 1.6, 1.6D, 1.6i, 1.6TurboRS, 1.6XR3i, 1.8D	01/1986 →; for OE: 1637182, 1637183	E		'H	CJ964
Track Control Arm	1.1, 1.3, 1.4, 1.6, 1.6D, 1.6i, 1.6TurboRS, 1.6XR3i, 1.8D	01/1986 →; for OE: 1637184, 1637185	E		'E	CJ965

ESCORT Mk IV Estate (AWF, AVF)

10/1985 → 10/1990

Track Control Arm	1.1, 1.4	→ 12/1985; for OE: 6087888	E		'H	CJ843
Track Control Arm	1.1, 1.4		E		'E	CJ844
Track Control Arm	1.1, 1.3, 1.4, 1.6, 1.6 D, 1.6 i, 1.8 D	01/1986 →; for OE: 1637182, 1637183	E		'H	CJ964
Track Control Arm	1.1, 1.3, 1.4, 1.6, 1.6 D, 1.6 i, 1.8 D	01/1986 →; for OE: 1637184, 1637185	E		'E	CJ965

ESCORT Mk V (GAL)

07/1990 → 12/1992

Track Control Arm	1.3, 1.4, 1.6, 1.8 16V XR3i, 1.8 D, RS 2000		E		'H	CJ124
Track Control Arm	1.3, 1.4, 1.6, 1.8 16V XR3i, 1.8 D, RS 2000		E		'E	CJ125
Rod/Strut, stabiliser	1.3, 1.4, 1.6, 1.8 16V XR3i, 1.8 D, RS 2000	for OE: 1661237; Material: Steel	E		'E 'H	CTR5318
Tie Rod Axle Joint	RS 2000		E		'E 'H	RE5450

ESCORT Mk V Convertible (ALL)









07/1990 → 12/1992

Track Control Arm	1.4, 1.6, 1.8 16V XR3i		E		'H	CJ124
Track Control Arm	1.4, 1.6, 1.8 16V XR3i		E		'E	CJ125
Rod/Strut, stabiliser	1.4, 1.6, 1.8 16V XR3i	for OE: 1661237; Material: Steel	E		'E 'H	CTR5318

ESCORT Mk V Estate (GAL, AVL)

07/1990 → 12/1992

Track Control Arm	1.3, 1.4, 1.6, 1.8 16V, 1.8 D		E		'H	CJ124
Track Control Arm	1.3, 1.4, 1.6, 1.8 16V, 1.8 D		E		'E	CJ125
Rod/Strut, stabiliser	1.3, 1.4, 1.6, 1.8 16V, 1.8 D	for OE: 1661237; Material: Steel	E		'E 'H	CTR5318

						
CJ124	CJ125	CTR5318	CJ843	CJ844	CJ964	CJ965
Ref.Nr.: 91AB3042AD	Ref.Nr.: 95AB3051AB	Ref.Nr.: YS413B438BA	Ref.Nr.: 3246130	Ref.Nr.: 5021457	Ref.Nr.: 1637182	Ref.Nr.: 1637185
						
RE5450						
Ref.Nr.: 6135757						

Article Description			Fitting Position	Article No.
---------------------	---	---	------------------	-------------

ESCORT Mk VI (GAL)

09/1992 → 01/1995

Track Control Arm	1.3, 1.4, 1.6i 16V, 1.8 16V XR3i, 1.8D, 1.8i 16V, 1.8TD, 1.8 XR3i 16V 4x4, RS 2000, RS 2000 4x4		E		H	CJ124
Track Control Arm	1.3, 1.4, 1.6i 16V, 1.8 16V XR3i, 1.8D, 1.8i 16V, 1.8TD, 1.8 XR3i 16V 4x4, RS 2000, RS 2000 4x4		E	E		CJ125
Rod/Strut, stabiliser	1.3, 1.4, 1.6i 16V, 1.8D, 1.8i 16V, 1.8TD, 1.8 16V XR3i, 1.8 XR3i 16V 4x4, RS 2000, RS 2000 4x4, RS Cosworth 4x4	for OE: 1661237; Material: Steel	E	E	H	CTR5318
Tie Rod Axle Joint	RS 2000, RS 2000 4x4, RS Cosworth 4x4		E	E	H	RE5450

ESCORT Mk VI Convertible (ALL)

12/1992 → 01/1995

Track Control Arm	1.4, 1.4 i, 1.6 16V XR3i, 1.6 i 16V, 1.8 16V XR3i		E		H	CJ124
Track Control Arm	1.4, 1.4 i, 1.6 16V XR3i, 1.6 i 16V, 1.8 16V XR3i		E	E		CJ125
Rod/Strut, stabiliser	1.4, 1.4 i, 1.6 16V XR3i, 1.6 i 16V, 1.8 16V XR3i	for OE: 1661237; Material: Steel	E	E	H	CTR5318

ESCORT Mk VI Estate (GAL)

09/1992 → 01/1995

Track Control Arm	1.3, 1.4, 1.6 i 16V, 1.8 D, 1.8 i 16V, 1.8 TD		E		H	CJ124
Track Control Arm	1.3, 1.4, 1.6 i 16V, 1.8 D, 1.8 i 16V, 1.8 TD		E	E		CJ125
Rod/Strut, stabiliser	1.3, 1.4, 1.6 i 16V, 1.8 D, 1.8 i 16V, 1.8 TD	for OE: 1661237; Material: Steel	E	E	H	CTR5318

ESCORT Mk VI Saloon (GAL)

08/1993 → 01/1995

Track Control Arm	1.3, 1.4, 1.6 i 16V, 1.8 D, 1.8 i 16V, 1.8 TD		E		H	CJ124
Track Control Arm	1.3, 1.4, 1.6 i 16V, 1.8 D, 1.8 i 16V, 1.8 TD		E	E		CJ125
Rod/Strut, stabiliser	1.3, 1.4, 1.6 i 16V, 1.8 D, 1.8 i 16V, 1.8 TD	for OE: 1661237; Material: Steel	E	E	H	CTR5318

ESCORT Mk VII (GAL, AAL, ABL)

01/1995 → 10/1998

Track Control Arm	1.3, 1.4, 1.6 16V, 1.6 16V 4x4, 1.6i 16V, 1.8 16V, 1.8 D, 1.8 TD, 1.8 Turbo D, RS 2000, RS 2000 4x4		E		H	CJ124
Track Control Arm	1.3, 1.4, 1.6 16V, 1.6 16V 4x4, 1.6i 16V, 1.8 16V, 1.8 D, 1.8 TD, 1.8 Turbo D, RS 2000, RS 2000 4x4		E	E		CJ125
Rod/Strut, stabiliser	1.3, 1.4, 1.6 16V, 1.6 16V 4x4, 1.6i 16V, 1.8 16V, 1.8 D, 1.8 TD, 1.8 Turbo D, RS 2000, RS 2000 4x4, RS Cosworth 4x4	Material: Steel	E	E	H	CTR5318

ESCORT Mk VII Convertible (ALL)

02/1995 → 08/2000

Track Control Arm	1.4, 1.6 16V XR3i, 1.8 16V XR3i, 1.8 TD, 1.8 Turbo D		E		H	CJ124
Track Control Arm	1.4, 1.6 16V XR3i, 1.8 16V XR3i, 1.8 TD, 1.8 Turbo D		E	E		CJ125
Rod/Strut, stabiliser	1.4, 1.6 16V XR3i, 1.8 16V XR3i, 1.8 TD, 1.8 Turbo D	Material: Steel	E	E	H	CTR5318

ESCORT Mk VII Saloon (GAL, AFL)

01/1995 → 02/1999

Track Control Arm	1.3, 1.4, 1.6 i 16V, 1.8 16V, 1.8 D, 1.8 TD, 1.8 Turbo D		E		H	CJ124
Track Control Arm	1.3, 1.4, 1.6 i 16V, 1.8 16V, 1.8 D, 1.8 TD, 1.8 Turbo D		E	E		CJ125
Rod/Strut, stabiliser	1.3, 1.4, 1.6 i 16V, 1.8 16V, 1.8 D, 1.8 TD, 1.8 Turbo D	Material: Steel	E	E	H	CTR5318

ESCORT Mk VII Estate (GAL, ANL)





01/1995 → 02/1999

Track Control Arm	1.3, 1.4, 1.6 16V, 1.6i 16V, 1.8 16V, 1.8 D, 1.8 TD, 1.8 Turbo		E		H	CJ124
Track Control Arm	1.3, 1.4, 1.6 16V, 1.6i 16V, 1.8 16V, 1.8 D, 1.8 TD, 1.8 Turbo		E	E		CJ125
Rod/Strut, stabiliser	1.3, 1.4, 1.6 16V, 1.6i 16V, 1.8 16V, 1.8 D, 1.8 TD, 1.8 Turbo	Material: Steel	E	E	H	CTR5318

FIESTA Mk IV (JA_, JB_)

08/1995 → 01/2002

Control Arm-/Trailing Arm Bush	1.0i, 1.25i 16V, 1.3i, 1.4i 16V, 1.6 16V Sport, 1.8 D, 1.8 DI		E	E	H	BS6496
--------------------------------	---	--	---	---	---	--------

				
BS6496	CJ124	CJ125	CTR5318	RE5450
Ref.Nr.: 96FB3063AA	Ref.Nr.: 91AB3042AD	Ref.Nr.: 95AB3051AB	Ref.Nr.: YS413B438BA	Ref.Nr.: 6135757

Article Description			Fitting Position	Article No.
---------------------	---	---	------------------	-------------

FIESTA Mk IV (JA_, JB_)

08/1995 → 01/2002

Control Arm-/Trailing Arm Bush	1.0 i, 1.25 i 16V, 1.3 i, 1.4 i 16V, 1.6 16V Sport, 1.8 D, 1.8 DI		E	'E	'H	BS7411
Track Control Arm	1.0 i, 1.1, 1.25 i 16V, 1.3 i, 1.4 i 16V, 1.8 D	→ 05/1998; for vehicles with power steering	E	'E		CJ159L
Track Control Arm	1.0 i, 1.1, 1.25 i 16V, 1.3 i, 1.4 i 16V, 1.8 D	→ 05/1998; for vehicles with power steering	E		'H	CJ159R
Ball Joint	1.0 i, 1.25 i 16V, 1.3 i, 1.4 i 16V, 1.6 16V Sport, 1.8 D, 1.8 DI	with fastening material	E	'E	'H	CJ582
Rod/Strut, stabiliser	1.0 i, 1.25 i 16V, 1.3 i, 1.4 i 16V, 1.6 16V Sport, 1.8 D, 1.8 DI	for OE: 1004018; Material: Steel	E	'E	'H	CTR5318

FIESTA V (JH_, JD_)

11/2001 → 06/2008

Rod/Strut, stabiliser	1.25 16V, 1.3, 1.4 16V, 1.4 TDCi, 1.6 16V, 1.6 TDCi, ST150		E	'E	'H	CTR6172
Tie Rod Axle Joint	1.25 16V, 1.3, 1.4 16V, 1.4 TDCi, 1.6 16V, 1.6 TDCi, ST150		E	'E	'H	RE5571

FIESTA VI

06/2008 →

Rod/Strut, stabiliser	1.0, 1.0 EcoBoost, 1.0 Sport, 1.25, 1.4, 1.4 LPG, 1.4 TDCi, 1.5 TDCi, 1.6, 1.6 ST, 1.6 TDCi, 1.6 Ti	Material: Aluminium	E	'E	'H	CTR1418
Tie Rod Axle Joint	1.0, 1.0 EcoBoost, 1.0 Sport, 1.25, 1.4, 1.4 LPG, 1.4 TDCi, 1.5 TDCi, 1.6, 1.6 TDCi, 1.6 Ti	not for country-spec. model: Russia, Turkey; Prod. date 05.11.2012→	E	'E	'H	RE6092

FIESTA Saloon

10/2012 →

Rod/Strut, stabiliser	1.25	Material: Aluminium	E	'E	'H	CTR1418
Tie Rod Axle Joint	1.25	not for country-spec. model: Russia, Turkey; Prod. date 05.11.2012→	E	'E	'H	RE6092

FOCUS (DAW, DBW)

10/1998 → 11/2004

Rod/Strut, stabiliser	1.4 16V, 1.6 16V, 1.8 16V, 1.8 DI/TDDi, 1.8 Turbo DI/TDDi, 1.8 TDCi, 2.0 16V, ST170	for OE: 1061631; Material: Steel	E	'E	'H	CTR5318
-----------------------	---	----------------------------------	---	----	----	---------

FOCUS Saloon (DFW)

02/1999 → 11/2004

Rod/Strut, stabiliser	1.4 16V, 1.6 16V, 1.8 16V, 1.8 Turbo DI/TDDi, 1.8 TDCi, 2.0 16V	for OE: 1061631; Material: Steel	E	'E	'H	CTR5318
-----------------------	---	----------------------------------	---	----	----	---------

FOCUS II (DA_)

07/2004 → 09/2012

Ball Joint	1.4, 1.6, 1.6 TDCi, 1.6 Ti, 1.8 TDCi, 2.0, 2.0 TDCi, 2.5 ST	Prod. date 27.02.2006→	E	'E	'H	CJ1259	
Tie Rod End	1.4, 1.6, 1.6 TDCi, 1.6 Ti, 1.8 TDCi, 2.0, 2.0 TDCi, 2.5 ST		E	'E		CTR5921L	
Tie Rod End	1.4, 1.6, 1.6 TDCi, 1.6 Ti, 1.8 TDCi, 2.0, 2.0 TDCi, 2.5 ST		E		'H	CTR5921R	
Rod/Strut, stabiliser	1.4, 1.6, 1.6 TDCi, 1.6 Ti, 1.8 Flexifuel, 1.8 TDCi, 2.0, 2.0 TDCi, 2.5 ST		E			CTR5923	
Rod/Strut, stabiliser	1.4, 1.6, 1.6 TDCi, 1.6 Ti, 1.8 Flexifuel, 1.8 TDCi, 2.0, 2.0 TDCi, 2.5 ST			Z	'E	'H	CTR6191

FOCUS II Saloon (DA_)













04/2005 → 09/2012



Ball Joint	1.4, 1.6, 1.6 TDCi, 1.6 Ti, 1.8 TDCi, 2.0, 2.0 TDCi	Prod. date 27.02.2006→	E	'E	'H	CJ1259	
Rod/Strut, stabiliser	1.4, 1.6, 1.6 TDCi, 1.6 Ti, 1.8 Flexifuel, 1.8 TDCi, 2.0, 2.0 TDCi		E			CTR5923	
Rod/Strut, stabiliser	1.4, 1.6, 1.6 TDCi, 1.6 Ti, 1.8 Flexifuel, 1.8 TDCi, 2.0, 2.0 TDCi			Z	'E	'H	CTR6191

FOCUS C-MAX











10/2003 → 03/2007

Ball Joint	1.6, 1.6 TDCi, 1.6 Ti, 1.8, 1.8 Flexifuel, 1.8 TDCi, 2.0, 2.0 TDCi	Prod. date 27.02.2006→	E	'E	'H	CJ1259
Tie Rod End	1.6, 1.6 TDCi, 1.6 Ti, 1.8, 1.8 Flexifuel, 1.8 TDCi, 2.0, 2.0 TDCi		E	'E		CTR5921L
Tie Rod End	1.6, 1.6 TDCi, 1.6 Ti, 1.8, 1.8 Flexifuel, 1.8 TDCi, 2.0, 2.0 TDCi		E		'H	CTR5921R
Rod/Strut, stabiliser	1.6, 1.6 TDCi, 1.6 Ti, 1.8, 1.8 Flexifuel, 1.8 TDCi, 2.0, 2.0 TDCi		E			CTR5923

						
BS7411	CJ1259	CJ159L	CJ159R	CJ582	CTR1418	CTR5318
Ref.Nr.: 98FB3A262AA	Ref.Nr.: 1679388	Ref.Nr.: 1E0034350A	Ref.Nr.: 1003575	Ref.Nr.: 7152281	Ref.Nr.: 8V513B438AB	Ref.Nr.: YS413B438BA
						
CTR5921R	CTR5923	CTR6172	CTR6191	RE5571	RE6092	
Ref.Nr.: 1317446	Ref.Nr.: 3M513B438AB	Ref.Nr.: 2S613B438AE	Ref.Nr.: 1310333	Ref.Nr.: 4342539	Ref.Nr.: 8V513L519AA	

Article Description			Fitting Position	Article No.
FOCUS C-MAX				10/2003 → 03/2007
Rod/Strut, stabiliser	1.6 TDCi, 1.6 Ti, 1.8, 1.8 Flexifuel, 1.8 TDCi, 2.0, 2.0 TDCi		Z 'E 'H	CTR6191
FUSION (JU_)				08/2002 → 12/2012
Rod/Strut, stabiliser	1.25, 1.4, 1.4 TDCi, 1.6, 1.6 TDCi		E 'E 'H	CTR6172
Tie Rod Axle Joint	1.25, 1.4, 1.4 TDCi, 1.6, 1.6 TDCi		E 'E 'H	RE5571
IKON				01/2001 → 12/2006
Control Arm-Trailing Arm Bush	1.3i LX,1.6i,LX,CLX	Front Control Arm Bush Rear ID 12/OD37/L62	E 'E 'H	BS6496
Control Arm-Trailing Arm Bush	1.3i LX,1.6i,LX,CLX	Control Arm Bush Front ID12/OD66/L51	E 'E 'H	BS7411
Track Control Arm	1.3i LX,1.6i,LX,CLX	P/S	E 'E	CJ159L
Track Control Arm	1.3i LX,1.6i,LX,CLX	P/S	E 'H	CJ159R
Ball Joint	1.3i LX,1.6i,LX,CLX		E 'E 'H	CJ582
Tie Rod Axle Joint	1.3i LX,1.6i,LX,CLX	P/S	E 'E 'H	RE5571
KA (RB_)				09/1996 → 11/2008
Ball Joint	1.0 i, 1.3 i, 1.6 i	with fastening material	E 'E 'H	CJ582
Rod/Strut, stabiliser	1.0 i, 1.3 i, 1.6 i	for OE: 1661237; Material: Steel	E 'E 'H	CTR5318
LAZER/TRACER				01/1986 → 12/2002
Ball Joint	1.3,1.5,1.6,1.6i		E 'E 'H	CJ926
Tie Rod End	1.3,1.5,1.6,1.6i		E 'E 'H	CTR5184
Tie Rod Axle Joint	1.3,1.5,1.6,1.6i	M/S	E 'E 'H	RE014

FORD

						
BS6496	BS7411	CJ159L	CJ159R	CJ582	CJ926	CTR5184
Ref.Nr.: 96FB3063AA	Ref.Nr.: 98FB3A262AA	Ref.Nr.: 1E0034350A	Ref.Nr.: 1003575	Ref.Nr.: 7152281	Ref.Nr.: B00134550	Ref.Nr.: 8AB032280
						
CTR5318	CTR6172	CTR6191	RE014	RE5571		
Ref.Nr.: YS413B438BA	Ref.Nr.: 2S613B438AE	Ref.Nr.: 1310333	Ref.Nr.: BF673224X	Ref.Nr.: 4342539		

Article Description			Fitting Position	Article No.
---------------------	---	---	------------------	-------------

METEOR

01/1986 → 12/1995

Ball Joint	1.3,1.4,1.5,1.6,2.0,GL,GLS,GLE,GLI		E	'E 'H	CJ926
Tie Rod End	1.3,1.4,1.5,1.6,2.0,GL,GLS,GLE,GLI		E	'E 'H	CTR5184
Tie Rod Axle Joint	1.3,1.4,1.5,1.6,2.0,GL,GLS,GLE,GLI	M/S	E	'E 'H	RE014

RANGER (ER, EQ)

10/1999 → 06/2006

Tie Rod End	2.3 4x4, 2.5 D, 2.5 D 4x4, 2.5 TD 4x4		E	'E 'H	CTR5335
-------------	---------------------------------------	--	---	-------	---------

RANGER 2X4 STD

01/1999 → 12/2009

Ball Joint	1.8,2.2,2.5TD,XL,XLT,4.0 V6,XLE,SUPERCAB,S/CAB,D/CAB	Upper	E	'E 'H	CJ918
Ball Joint	1.8,2.2,2.5TD,XL,XLT,4.0 V6,XLE,SUPERCAB,S/CAB,D/CAB	Lower	E	'E 'H	CJ919
Tie Rod End	1.8,2.2,2.5TD,XL,XLT,4.0 V6,XLE,SUPERCAB,S/CAB,D/CAB	Inner	E	'E 'H	CTR5338
Tie Rod End	1.8,2.2,2.5TD,XL,XLT,4.0 V6,XLE,SUPERCAB,S/CAB,D/CAB	Outer	E	'E 'H	CTR5339

SIERRA Hatchback (GBC)











08/1982 → 12/1986

Tie Rod Axle Joint	1.3, 1.6, 1.8, 2.0, 2.0 i, 2.3, 2.3 D, 2.8 XR 4x4, 2.8 XR4i	for OE: 6131083	E	'E 'H	RE5407
Tie Rod Axle Joint	1.6		E	'E 'H	RE5407
Tie Rod Axle Joint	2.8 XR4i	for left-hand drive vehicles	E	'E 'H	RE5450

RANGER 4X4/HI-TRAIL

01/1999 → 12/2007

Ball Joint	2.5TD,XL,XLT,4.0 V6,XLE,SUPERCAB,S/CAB,D/CAB	Upper	E	'E 'H	CJ918
------------	--	-------	---	-------	-------

						
CJ918	CJ919	CJ926	CTR5184	CTR5335	CTR5338	CTR5339
Ref.Nr.:	Ref.Nr.: K9597	Ref.Nr.: B00134550	Ref.Nr.: 8AB032280	Ref.Nr.: XM343289BA	Ref.Nr.:	Ref.Nr.:
						
RE014	RE5407	RE5450				
Ref.Nr.: BF673224X	Ref.Nr.: 6134277	Ref.Nr.: 6135757				

Article Description			Fitting Position	Article No.
---------------------	---	---	------------------	-------------

RANGER 4X4/HI-TRAIL

01/2007 → 12/2014

Ball Joint	2.5TD,XL,XLT,4.0 V6,XLE,SUPERCAB,S/CAB,D/CAB	Lower	E	'E	'H	CJ1205
Ball Joint	2.5TD,XL,XLT,4.0 V6,XLE,SUPERCAB,S/CAB,D/CAB	Upper	E	'E	'H	CJ918
Ball Joint	2.5TD,XL,XLT,4.0 V6,XLE,SUPERCAB,S/CAB,D/CAB	Hi Trail Lower	E	'E	'H	CJ983
Tie Rod End	2.5TD,XL,XLT,4.0 V6,XLE,SUPERCAB,S/CAB,D/CAB	Hi Trail Inner Alt	E	'E	'H	CTR5308
Tie Rod End	2.5TD,XL,XLT,4.0 V6,XLE,SUPERCAB,S/CAB,D/CAB	Inner	E	'E	'H	CTR5308
Tie Rod End	2.5TD,XL,XLT,4.0 V6,XLE,SUPERCAB,S/CAB,D/CAB	Outer	E	'E	'H	CTR5335
Tie Rod End	2.5TD,XL,XLT,4.0 V6,XLE,SUPERCAB,S/CAB,D/CAB	Inner	E	'E	'H	CTR5984

SIERRA Estate (BNC)

08/1982 → 12/1986

Tie Rod Axle Joint	1.6, 1.8, 2.0, 2.3, 2.3 D, 2.8 XR4i	for OE: 6131083	E	'E	'H	RE5407
--------------------	-------------------------------------	-----------------	---	----	----	--------

SIERRA (GBG, GB4)

01/1987 → 02/1993

Tie Rod Axle Joint	1.6, 1.6i, 1.8, 1.8TD, 2.0, 2.0 4x4, 2.0i, 2.0i CAT, 2.3D, 2.9 4x4, 2.9 i	for OE: 6131083	E	'E	'H	RE5407
Tie Rod Axle Joint	1.8 TD, 2.3 D, 2.9 i	for left-hand drive vehicles	E	'E	'H	RE5450

SIERRA Hatchback (GBC, GBG)

01/1987 → 02/1993

Tie Rod Axle Joint	1.6, 1.6i, 1.8, 1.8TD, 2.0, 2.0 16V Cosworth 4x4, 2.0 16V Cosworth 4x4 CAT, 2.0i, 2.0i CAT, 2.0 RSCosworth, 2.3D, 2.8 i XR 4x4, 2.9 i, 2.9 i XR 4x4	for OE: 6131083	E	'E	'H	RE5407
Tie Rod Axle Joint	2.0 i		E	'E	'H	RE5407
Tie Rod Axle Joint	1.8 TD, 2.3 D, 2.8 i XR 4x4, 2.9 i	for left-hand drive vehicles	E	'E	'H	RE5450

SIERRA Estate (BNG)

01/1987 → 02/1993

Tie Rod Axle Joint	1.6, 1.6i, 1.8, 1.8TD, 2.0, 2.0 4x4, 2.0i, 2.0i CAT, 2.3D, 2.8 4x4, 2.9, 2.9 4x4, 2.9 i	for OE: 6131083	E	'E	'H	RE5407
Tie Rod Axle Joint	1.8 TD, 2.3 D, 2.8 4x4, 2.9	for left-hand drive vehicles	E	'E	'H	RE5450

TOURNEO COURIER Kombi

02/2014 →

Rod/Strut, stabiliser	1.0 EcoBoost, 1.5 TDCi, 1.6 TDCi	Material: Aluminium	E	'E	'H	CTR1418
Tie Rod Axle Joint	1.0 EcoBoost, 1.5 TDCi, 1.6 TDCi		E	'E	'H	RE6092

TRANSIT COURIER Box











02/2014 →

Rod/Strut, stabiliser	1.0 EcoBoost, 1.5 TDCi, 1.6 TDCi	Material: Aluminium	E	'E	'H	CTR1418
Tie Rod Axle Joint	1.0 EcoBoost, 1.5 TDCi, 1.6 TDCi		E	'E	'H	RE6092

TRANSIT COURIER Kombi

02/2014 →

Rod/Strut, stabiliser	1.0 EcoBoost, 1.5 TDCi, 1.6 TDCi	Material: Aluminium	E	'E	'H	CTR1418
Tie Rod Axle Joint	1.0 EcoBoost, 1.5 TDCi, 1.6 TDCi		E	'E	'H	RE6092

						
CJ1205	CJ918	CJ983	CTR1418	CTR5308	CTR5335	CTR5984
Ref.Nr.: UR6134550	Ref.Nr.:	Ref.Nr.: 8AU334510	Ref.Nr.: 8V513B438AB	Ref.Nr.: 6M343280AA	Ref.Nr.: XM343289BA	Ref.Nr.: UR5632250
						
RE5407	RE5450	RE6092				
Ref.Nr.: 6134277	Ref.Nr.: 6135757	Ref.Nr.: 8V513L519AA				

Article Description			Fitting Position	Article No.
----------------------------	---	---	-------------------------	--------------------

FOTON 2.2 P/VAN,BUS

01/2007 →

Ball Joint	2,2	Lower Alternative	E	'E	'H	CJ281
Ball Joint	2,2	Lower	E	'E	'H	CJ931
Tie Rod End	2,2	Outer 17 mm	E	'E	'H	CTR5005
Tie Rod End	2,2	Outer 15 mm	E	'E	'H	CTR5005A
Tie Rod Axle Joint	2,2	17 mm	E	'E	'H	RE049
Tie Rod Axle Joint	2,2	15 mm	E	'E	'H	RE188

					
<p>CJ281</p> <p>Ref.Nr.: 4333029175</p>	<p>CJ931</p> <p>Ref.Nr.: 4333029125</p>	<p>CTR5005</p> <p>Ref.Nr.: 4504669055</p>	<p>CTR5005A</p> <p>Ref.Nr.: 4504629325</p>	<p>RE049</p> <p>Ref.Nr.: 4550329255</p>	<p>RE188</p> <p>Ref.Nr.: 4550329565</p>

GONOW

Article Description			Fitting Position	Article No.
---------------------	---	---	------------------	-------------

X-SPACE

01/2007 →

Ball Joint	2.2I	Upper	E	E	H	CJ933
Ball Joint	2.2I	Lower	E	E	H	CJ934

GONOW

		
<p>CJ933</p>	<p>CJ934</p>	
<p>Ref.Nr.: 4335039035</p>	<p>Ref.Nr.: 4333039165</p>	

Article Description			Fitting Position	Article No.
---------------------	---	---	------------------	-------------

GWM 2.2

01/2007 →

Ball Joint	2,2	Upper	E	'E	'H	CJ933
Ball Joint	2,2	Lower	E	'E	'H	CJ934

	
<p>CJ933</p>	<p>CJ934</p>
<p>Ref.Nr.: 4335039035</p>	<p>Ref.Nr.: 4333039165</p>

HONDA

Article Description			Fitting Position	Article No.
---------------------	---	---	------------------	-------------

BALLADE

01/1989 → 12/1996

Ball Joint	150I,160I,180I,ENCORE,LUXLINE,SPREELINE,V-TEC	Lower	E	'E	'H	CJ962
Ball Joint	150I,160I,180I,ENCORE,LUXLINE,SPREELINE,V-TEC	Upper	E	'E	'H	CJ967
Tie Rod End	150I,160I,180I,ENCORE,LUXLINE,SPREELINE,V-TEC		E	'E		CTR5345L
Tie Rod End	150I,160I,180I,ENCORE,LUXLINE,SPREELINE,V-TEC		E		'H	CTR5345R
Rod/Strut, stabiliser	150I,160I,180I,ENCORE,LUXLINE,SPREELINE,V-TEC		E	'E	'H	CTR5552

BALLADE

01/1992 → 12/2000

Track Control Arm	150I,160I,180I,ENCORE,LUXLINE,SPREELINE,V-TEC		E	'E		CJ610L
Track Control Arm	150I,160I,180I,ENCORE,LUXLINE,SPREELINE,V-TEC		E		'H	CJ610R
Ball Joint	150I,160I,180I,ENCORE,LUXLINE,SPREELINE,V-TEC	Lower	E	'E	'H	CJ962
Ball Joint	150I,160I,180I,ENCORE,LUXLINE,SPREELINE,V-TEC	Upper	E	'E	'H	CJ967
Tie Rod End	150I,160I,180I,ENCORE,LUXLINE,SPREELINE,V-TEC		E	'E		CTR5345L
Tie Rod End	150I,160I,180I,ENCORE,LUXLINE,SPREELINE,V-TEC		E		'H	CTR5345R
Rod/Strut, stabiliser	150I,160I,180I,ENCORE,LUXLINE,SPREELINE,V-TEC		E	'E	'H	CTR5552
Tie Rod Axle Joint	150I,160I,180I,ENCORE,LUXLINE,SPREELINE,V-TEC		E	'E	'H	RE071

CIVIC

01/1996 → 12/2000

Track Control Arm	150I,160I,180I,ENCORE,LUXLINE,SPREELINE,V-TEC		E	'E		CJ610L
Track Control Arm	150I,160I,180I,ENCORE,LUXLINE,SPREELINE,V-TEC		E		'H	CJ610R
Ball Joint	150I,160I,180I,ENCORE,LUXLINE,SPREELINE,V-TEC	Lower	E	'E	'H	CJ962
Ball Joint	150I,160I,180I,ENCORE,LUXLINE,SPREELINE,V-TEC	Upper	E	'E	'H	CJ967
Tie Rod End	150I,160I,180I,ENCORE,LUXLINE,SPREELINE,V-TEC		E	'E		CTR5345L
Tie Rod End	150I,160I,180I,ENCORE,LUXLINE,SPREELINE,V-TEC		E		'H	CTR5345R
Rod/Strut, stabiliser	150I,160I,180I,ENCORE,LUXLINE,SPREELINE,V-TEC		E	'E	'H	CTR5552
Tie Rod Axle Joint	150I,160I,180I,ENCORE,LUXLINE,SPREELINE,V-TEC		E	'E	'H	RE071

CIVIC

01/2000 → 12/2005

Tie Rod Axle Joint	150I,170I,1.8I,2.0I,2.2I, V-TEC		E	'E	'H	RE5908
--------------------	---------------------------------	--	---	----	----	--------

CR-V

01/1997 → 12/2003

Ball Joint	2,0	Lower	E	'E	'H	CJ962
Tie Rod End	2,0		E	'E		CTR5345L
Tie Rod End	2,0		E		'H	CTR5345R
Rod/Strut, stabiliser	2,0		E	'E	'H	CTR5552

CRX

01/1991 → 12/1993

Ball Joint	1,6	Lower	E	'E	'H	CJ962
Ball Joint	1,6	Upper	E	'E	'H	CJ967
Tie Rod End	1,6		E	'E		CTR5345L
Tie Rod End	1,6		E		'H	CTR5345R
Rod/Strut, stabiliser	1,6		E	'E	'H	CTR5552
Tie Rod Axle Joint	1,6		E	'E	'H	RE071

						
CJ610L	CJ610R	CJ962	CJ967	CTR5345L	CTR5345R	CTR5552
Ref.Nr.: 51460S01023	Ref.Nr.: 51450S01023	Ref.Nr.: 51220SH3003	Ref.Nr.:	Ref.Nr.: 53560SH3003	Ref.Nr.: 53540SH3003	Ref.Nr.: 51320S04003
						
RE071	RE5908					
Ref.Nr.: 53010SR3010	Ref.Nr.: 53010S04000					

Article Description			Fitting Position	Article No.
---------------------	---	---	------------------	-------------

ACCENT

01/1994 → 12/2006

Ball Joint	1.3LS,XS,1.5 CSI,LS,RSI		E	'E 'H	CJ1011
Tie Rod End	1.3LS,XS,1.5 CSI,LS,RSI		E	'E 'H	CTR5474

ELANTRA J2

01/1995 → 12/2000

Ball Joint	1.6,1.8,2.0,GL,GLS,GLI		E	'E 'H	CJ1011
Rod/Strut, stabiliser	1.6,1.8,2.0,GL,GLS,GLI	Rear		Z 'E 'H	CTR3107
Tie Rod End	1.6,1.8,2.0,GL,GLS,GLI		E	'E 'H	CTR5474
Rod/Strut, stabiliser	1.6,1.8,2.0,GL,GLS,GLI	Front	E	'E 'H	CTR6032

ELANTRA J3

01/2000 → 12/2006

Ball Joint	1.6,1.8,2.0,GL,GLS,GLI		E	'E 'H	CJ1011
Rod/Strut, stabiliser	1.6,1.8,2.0,GL,GLS,GLI	Rear		Z 'E 'H	CTR3107
Tie Rod End	1.6,1.8,2.0,GL,GLS,GLI		E	'E 'H	CTR5474
Rod/Strut, stabiliser	1.6,1.8,2.0,GL,GLS,GLI	Front	E	'E 'H	CTR6032

ELANTRA J4

01/2006 →

Ball Joint	1.6,2.0,GLS		E	'E 'H	CJ1011
Tie Rod End	1.6,2.0,GLS		E	'E 'H	CTR5474

GETZ

01/2003 → 12/2007

Ball Joint	1.3,1.4I,1.6 HS,CRDI		E	'E 'H	CJ1011
Tie Rod End	1.3,1.4I,1.6 HS,CRDI		E	'E 'H	CTR5474
Rod/Strut, stabiliser	1.3,1.4I,1.6 HS,CRDI		E	'E	CTR5915L
Rod/Strut, stabiliser	1.3,1.4I,1.6 HS,CRDI		E	'H	CTR5915R

GETZ

01/2007 →

Ball Joint	1.4 GL,HS,1.5 CRDI,HS,1.6 GL,GLS,HS		E	'E 'H	CJ1011
Tie Rod End	1.4 GL,HS,1.5 CRDI,HS,1.6 GL,GLS,HS		E	'E 'H	CTR5474
Rod/Strut, stabiliser	1.4 GL,HS,1.5 CRDI,HS,1.6 GL,GLS,HS		E	'E	CTR5915L
Rod/Strut, stabiliser	1.4 GL,HS,1.5 CRDI,HS,1.6 GL,GLS,HS		E	'H	CTR5915R

I10

01/2009 →

Rack End	1.1 GLS,1.2 GLS,HS		E	'E 'H	RE6055
----------	--------------------	--	---	-------	--------

I20

01/2009 →

Ball Joint	1.4,1.6		E	'E 'H	CJ1011
------------	---------	--	---	-------	--------

SANTA FE

01/2001 → 12/2006

Tie Rod End	2.4,2.7		E	'E 'H	CTR5567
-------------	---------	--	---	-------	---------

SONATA

01/1994 → 12/1999

Tie Rod End	2.0 GL,GLS,3.0GLS		E	'E 'H	CTR5567
-------------	-------------------	--	---	-------	---------

TIBURON

01/1996 → 12/1999

Ball Joint	2.0 FX		E	'E 'H	CJ1011
Tie Rod End	2.0 FX		E	'E 'H	CTR5474

						
CJ1011	CTR3107	CTR5474	CTR5567	CTR5915L	CTR5915R	CTR6032
Ref.Nr.: 5450322A00	Ref.Nr.: 5553029500AS	Ref.Nr.: 5682037010	Ref.Nr.: 568203B000	Ref.Nr.: 548301C000	Ref.Nr.: 548401C000	Ref.Nr.: 5483029000
						
RE6055						
Ref.Nr.: 577240X000						

HYUNDAI

Article Description			Fitting Position	Article No.
---------------------	---	---	------------------	-------------

TIBURON

01/2000 →

Ball Joint	2.0 GL,CRDI,2.7 V6		E	'E	'H	CJ1011	
Rod/Strut, stabiliser	2.0 GL,CRDI,2.7 V6	Rear		Z	'E	'H	CTR3107
Tie Rod End	2.0 GL,CRDI,2.7 V6		E	'E	'H	CTR5474	
Rod/Strut, stabiliser	2.0 GL,CRDI,2.7 V6	Front	E	'E	'H	CTR6032	

TUSCON

01/2004 → 12/2010

Control Arm-/Trailing Arm Bush	2.0 GL,CRDI,2.7 V6		E	'E	'H	BS7860
--------------------------------	--------------------	--	---	----	----	--------

HYUNDAI

					
BS7860	CJ1011	CTR3107	CTR5474	CTR6032	
Ref.Nr.: 545842E000	Ref.Nr.: 5450322A00	Ref.Nr.: 5553029500AS	Ref.Nr.: 5682037010	Ref.Nr.: 5483029000	

Article Description			Fitting Position	Article No.
---------------------	---	---	------------------	-------------

KB 01/1981 → 12/2004

Ball Joint	1.6,1.8,2.0,2.2,2.3,2.5	Upper	E	'E 'H	CJ930
------------	-------------------------	-------	---	-------	-------

KB FLEETSIDE,LE,LX,2X4 01/1989 → 12/2004

Ball Joint	160,200,220,230,250D,260,280,300	Upper	E	'E 'H	CJ930
Ball Joint	160,200,220,230,250D,260,280,300	Lower	E	'E 'H	CJ936
Ball Joint	160,200,220,230,250D,260,280,300	Lower KB320 Only	E	'E 'H	CJ946
Tie Rod End	160,200,220,230,250D,260,280,300	Inner	E	'E 'H	CTR5331L
Tie Rod End	160,200,220,230,250D,260,280,300	Outer	E	'E 'H	CTR5331R
Stabilizer Link	KB320	2002 >		'E	CTR6182L
Stabilizer Link	KB320	2002 >		'H	CTR6182R

KB FLEETSIDE,LE,LX,2X4 01/2004 →

Ball Joint	220,240I,250D,300TDI LE,LX	Upper Std Suspension	E	'E 'H	CJ1221
Ball Joint	220,240I,250D,300TDI LE,LX	Lower	E	'E 'H	CJ946
Tie Rod End	220,240I,250D,300TDI LE,LX		E	'E 'H	CTR5806
Stabilizer Link	220,240I,250D,300TDI LE,LX			'E	CTR6182L
Stabilizer Link	220,240I,250D,300TDI LE,LX			'H	CTR6182R

KB 4X4 01/1980 → 12/1989

Ball Joint	1.6,1.8,2.0,2.2,	Upper	E	'E 'H	CJ930
------------	------------------	-------	---	-------	-------

KB 4X4/HIGHRIDER 01/1989 → 12/2004

Ball Joint	220,230,250D,260,280DT,300TDI,320	Upper	E	'E 'H	CJ930
Ball Joint	220,230,250D,260,280DT,300TDI,320	Lower	E	'E 'H	CJ946
Tie Rod End	220,230,250D,260,280DT,300TDI,320	Inner	E	'E	CTR5331L
Tie Rod End	220,230,250D,260,280DT,300TDI,320	Outer	E	'H	CTR5331R
Stabilizer Link	220,230,250D,260,280DT,300TDI,320			'E	CTR6182L
Stabilizer Link	220,230,250D,260,280DT,300TDI,320			'H	CTR6182R

KB 4X4/HIGHRIDER 01/2004 →









Ball Joint	240I,250D,300TDI LE,LX,FLEETSIDE	Lower	E	'E 'H	CJ946
Tie Rod End	240I,250D,300TDI LE,LX,FLEETSIDE		E	'E 'H	CTR5806
Stabilizer Link	240I,250D,300TDI LE,LX,FLEETSIDE			'E	CTR6182L
Stabilizer Link	240I,250D,300TDI LE,LX,FLEETSIDE			'H	CTR6182R

FRONTIER 01/1998 → 12/2002

Ball Joint	280 LX	Upper	E	'E 'H	CJ930
Ball Joint	KB320	Lower KB320 Only	E	'E 'H	CJ946
Tie Rod End		Inner	E	'E 'H	CTR5331L
Tie Rod End	280 LX	Outer	E	'E 'H	CTR5331R

TROOPER 01/1987 → 12/1991

Ball Joint		Lower	E	'E 'H	CJ936
------------	--	-------	---	-------	-------

						
CJ1221	CJ930	CJ936	CJ946	CTR5331L	CTR5331R	CTR5806
Ref.Nr.: 898005827051	Ref.Nr.: 8944594534	Ref.Nr.: 8944594641	Ref.Nr.: 94452102	Ref.Nr.: 8944594812	Ref.Nr.: 8944194081	Ref.Nr.: 897304855051
						
CTR6182L	CTR6182R					
Ref.Nr.: 8979445690	Ref.Nr.: 8979445680					

ISUZU

Article Description			Fitting Position	Article No.
---------------------	---	---	------------------	-------------

SPORTAGE (JE_, KM_)

09/2004 →

Control Arm-/Trailing Arm Bush	2.016V 4WD, 2.0CRDi, 2.0CRDi 4WD, 2.0i 16V, 2.7V64W	Rubber-metal Bearing	E	'E 'H	BS7860
--------------------------------	---	----------------------	---	-------	--------



BS7860

Ref.Nr.: 545842E000

Article Description			Fitting Position	Article No.
---------------------	---	---	------------------	-------------

2 (DE) 10/2007 → 06/2015

Rod/Strut, stabiliser	1.3, 1.3 MZR, 1.4 MZR-CD, 1.5, 1.5 MZR, 1.6 MZ-CD	Material: Aluminium	E	'E 'H	CTR1418
Tie Rod Axle Joint	1.3, 1.3 MZR, 1.4 MZR-CD, 1.5, 1.5 MZR, 1.6 MZ-CD		E	'E 'H	RE6092

2 Saloon (DE) 05/2010 → 06/2015

Rod/Strut, stabiliser	1.5 i	Material: Aluminium	E	'E 'H	CTR1418
-----------------------	-------	---------------------	---	-------	---------

3 (BK) 10/2003 → 06/2009

Track Control Arm	1.4, 1.6, 1.6 DI Turbo, 2.0, 2.0 MZR-CD, 2.3 DiSi Turbo MPS, 2.3 MPS, 2.3 MZR, 2.3 MZR Sport	Material: Sheet Steel; with ball joint, with rubber mounting; with holder	E	'E	CJ294L
Track Control Arm	1.4, 1.6, 1.6 DI Turbo, 2.0, 2.0 MZR-CD, 2.3 DiSi Turbo MPS, 2.3 MPS, 2.3 MZR, 2.3 MZR Sport	Material: Sheet Steel; with ball joint, with rubber mounting; with holder	E	'H	CJ294R
Rod/Strut, stabiliser	1.4, 1.6, 1.6 DI Turbo, 2.0, 2.3 MZR Sport		E		CTR5923
Rod/Strut, stabiliser	1.4, 1.6 DI Turbo, 2.0, 2.0 MZR-CD		Z	'E 'H	CTR6191
Tie Rod Axle Joint	1.4, 1.6, 1.6 DI Turbo, 2.0, 2.3 DiSi Turbo MPS, 2.3 MPS, 2.3 MZR, 2.3 MZR Sport		E	'E 'H	RE5946

3 Saloon (BK) 06/2000 → 06/2009

Track Control Arm	1.6, 1.6 DI Turbo, 2.0, 2.0 MZR-CD, 2.3	Material: Sheet Steel; with ball joint, with rubber mounting; with holder	E	'E	CJ294L
Track Control Arm	1.6, 1.6 DI Turbo, 2.0, 2.0 MZR-CD, 2.3	Material: Sheet Steel; with ball joint, with rubber mounting; with holder	E	'H	CJ294R
Rod/Strut, stabiliser	1.6, 1.6 DI Turbo, 2.0		E		CTR5923
Rod/Strut, stabiliser	1.6, 1.6 DI Turbo, 2.0, 2.0 MZR-CD		Z	'E 'H	CTR6191
Tie Rod Axle Joint	1.6, 1.6 DI Turbo, 2.0		E	'E 'H	RE5946

323 01/1981 → 12/1986

Ball Joint	1.3 HATCHBACK, SEDAN 1.5 HATCHBACK, SEDAN		E	'E 'H	CJ926
Tie Rod Axle Joint	1.3 HATCHBACK, SEDAN 1.5 HATCHBACK, SEDAN	M/S	E	'E 'H	RE014

323/STING/MIDGE 01/1984 → 12/1997











Ball Joint	1.3, 1.5, 1.6, 160I, 2.0, 200I HATCH, SEDAN, L, SLX, EGI		E	'E 'H	CJ926
Tie Rod End	1.3, 1.5, 1.6, 160I, 2.0, 200I HATCH, SEDAN, L, SLX, EGI		E	'E 'H	CTR5184
Tie Rod Axle Joint	1.3, 1.5, 1.6, 160I, 2.0, 200I HATCH, SEDAN, L, SLX, EGI	M/S	E	'E 'H	RE014

5 (CR19) 02/2005 →

Track Control Arm	1.8, 2.0, 2.0 CD, 2.3	Material: Sheet Steel; with ball joint, with rubber mounting; with holder	E	'E	CJ294L
Track Control Arm	1.8, 2.0, 2.0 CD, 2.3	Material: Sheet Steel; with ball joint, with rubber mounting; with holder	E	'H	CJ294R
Rod/Strut, stabiliser	1.8, 2.0, 2.0 CD		E		CTR5923
Rod/Strut, stabiliser	1.8, 2.0, 2.0 CD		Z	'E 'H	CTR6191
Tie Rod Axle Joint	1.8, 2.0, 2.0 CD		E	'E 'H	RE5946

5 (CW) 09/2010 →

Track Control Arm	1.6 CD, 2.0	Material: Sheet Steel; with ball joint, with rubber mounting; with holder	E	'E	CJ294L
Track Control Arm	1.6 CD, 2.0	Material: Sheet Steel; with ball joint, with rubber mounting; with holder	E	'H	CJ294R

						
CJ294L	CJ294R	CJ926	CTR1418	CTR5184	CTR5923	CTR6191
Ref.Nr.: CC3034350C	Ref.Nr.: BP4K34300C	Ref.Nr.: B00134550	Ref.Nr.: 8V513B438AB	Ref.Nr.: 8AB032280	Ref.Nr.: 3M513B438AB	Ref.Nr.: 1310333
						
RE014	RE5946	RE6092				
Ref.Nr.: BF673224X	Ref.Nr.: BP4L32240	Ref.Nr.: 8V513L519AA				

MAZDA

Article Description			Fitting Position	Article No.
---------------------	---	---	------------------	-------------

6 (GG)

06/2002 → 08/2007

Track Control Arm	1.8, 2.0, 2.0 DI, 2.3	Material: Steel	E	'E	'H	CJ1199
Tie Rod Axle Joint	1.8, 2.0, 2.0 DI, 2.3		E	'E	'H	RE5948

6 Hatchback (GG)

08/2002 → 08/2007

Track Control Arm	1.8, 2.0, 2.0 DI, 2.3	Material: Steel	E	'E	'H	CJ1199
-------------------	-----------------------	-----------------	---	----	----	--------

6 Station Wagon (GY)

08/2002 → 08/2007

Track Control Arm	1.8, 2.0, 2.0 DI, 2.3, 2.3 AWD	Material: Steel	E	'E	'H	CJ1199
-------------------	--------------------------------	-----------------	---	----	----	--------

121/SOHO

01/1997 → 12/1999

Ball Joint	1.3,1.4		E	'E	'H	CJ582
------------	---------	--	---	----	----	-------

B-SERIE/MAGNUM

01/1986 → 12/1999

Ball Joint	B1600,B1800,B200,B2200,B2500,B2600,B3000,B3400	Upper	E	'E	'H	CJ918
Ball Joint	B1600,B1800,B200,B2200,B2500,B2600,B3000,B3400	Lower	E	'E	'H	CJ919
Tie Rod End	B1600,B1800,B200,B2200,B2500,B2600,B3000,B3400	Inner	E	'E	'H	CTR5338
Tie Rod End	B1600,B1800,B200,B2200,B2500,B2600,B3000,B3400	Outer	E	'E	'H	CTR5339

BT-50

01/2007 → 12/2014

Ball Joint	2.5TDI2.6,3.0CRDI,FREESTYLE,SLX,S/CAB,D/CAB	Lower	E	'E	'H	CJ1205
Ball Joint	2.5TDI2.6,3.0CRDI,FREESTYLE,SLX,S/CAB,D/CAB	Upper	E	'E	'H	CJ918
Tie Rod End	2.5TDI2.6,3.0CRDI,FREESTYLE,SLX,S/CAB,D/CAB	Inner	E	'E	'H	CTR5984

DRIFTER 2X4 STD

01/2000 → 12/2007

Ball Joint	2.5TDI,2.6,3.0CRDI,FREESTYLE,SLX,S/CAB,D/CAB	Upper	E	'E	'H	CJ918
Ball Joint	2.5TDI,2.6,3.0CRDI,FREESTYLE,SLX,S/CAB,D/CAB	Lower	E	'E	'H	CJ919
Tie Rod End	2.5TDI,2.6,3.0CRDI,FREESTYLE,SLX,S/CAB,D/CAB	Inner	E	'E	'H	CTR5338
Tie Rod End	2.5TDI,2.6,3.0CRDI,FREESTYLE,SLX,S/CAB,D/CAB	Outer	E	'E	'H	CTR5339

DRIFTER 4X4/Hi-TRAIL

01/2000 → 12/2007

Ball Joint	2.5TDI2.6,3.0CRDI,FREESTYLE,SLX,S/CAB,D/CAB	Upper	E	'E	'H	CJ918
Ball Joint	2.5TDI2.6,3.0CRDI,FREESTYLE,SLX,S/CAB,D/CAB	Hi Trail Lower	E	'E	'H	CJ983
Tie Rod End	2.5TDI2.6,3.0CRDI,FREESTYLE,SLX,S/CAB,D/CAB	Hi Trail Inner Alt	E	'E	'H	CTR5308
Tie Rod End	2.5TDI2.6,3.0CRDI,FREESTYLE,SLX,S/CAB,D/CAB	Inner	E	'E	'H	CTR5308
Tie Rod End	2.5TDI2.6,3.0CRDI,FREESTYLE,SLX,S/CAB,D/CAB	Outer	E	'E	'H	CTR5335

MAZDA

						
CJ1199	CJ1205	CJ582	CJ918	CJ919	CJ983	CTR5308
Ref.Nr.: GJ6A34300B	Ref.Nr.: UR6134550	Ref.Nr.: 7152281	Ref.Nr.:	Ref.Nr.: K9597	Ref.Nr.: 8AU334510	Ref.Nr.: 6M343280AA
						
CTR5335	CTR5338	CTR5339	CTR5984	RE5948		
Ref.Nr.: XM343289BA	Ref.Nr.:	Ref.Nr.:	Ref.Nr.: UR5632250	Ref.Nr.: GJ6A32240		

Article Description			Fitting Position	Article No.
---------------------	---	---	------------------	-------------

MIDGE/STING

01/1991 → 12/2004

Ball Joint	130,160,200I,HATCH,SEDAN		E	'E 'H	CJ926
Tie Rod End	130,160,200I,HATCH,SEDAN		E	'E 'H	CTR5184
Tie Rod Axle Joint	130,160,200I,HATCH,SEDAN	M/S	E	'E 'H	RE014

MX-3 (EC)

07/1991 → 10/1997

Tie Rod End	1.6 i, 1.8 i V6		E	'E 'H	CTR5184
-------------	-----------------	--	---	-------	---------

RUSTLER

01/1985 → 12/1986

Track Control Arm	1.3,1.4,1.6		E	'H	CJ843
Track Control Arm	1.3,1.4,1.6		E	'E 'H	CJ844
Track Control Arm	1.3,1.4,1.6		E	'H	CJ964
Track Control Arm	1.3,1.4,1.6		E	'E 'H	CJ965
Tie Rod End	130,160,160I		E	'E 'H	CTR5184
Tie Rod Axle Joint	130,160,160I	M&S	E	'E 'H	RE014

RX 7 Mk III (FD)

07/1992 → 08/2002

Tie Rod End	Wankel Twin Turbo		E	'E 'H	CTR5184
-------------	-------------------	--	---	-------	---------

						
CJ843	CJ844	CJ926	CJ964	CJ965	CTR5184	RE014
Ref.Nr.: 3246130	Ref.Nr.: 5021457	Ref.Nr.: B00134550	Ref.Nr.: 1637182	Ref.Nr.: 1637185	Ref.Nr.: 8AB032280	Ref.Nr.: BF673224X

MERCEDES-BENZ

Article Description			Fitting Position	Article No.
---------------------	---	---	------------------	-------------

A-CLASS (W169)

09/2004 → 06/2012

Ball Joint	A 150, A 160, A 160 CDI, A 170, A 180, A 180 CDI, A 200, A 200 CDI, A 200 TURBO, E-CELL	Number of mounting bores: 3; with fastening material	E	'E	'H	CJ1143
------------	---	--	---	----	----	--------

B-CLASS (W245)

03/2005 → 11/2011

Ball Joint	B 150, B 160, B 170, B 170 NGT, B 180, B 180 CDI, B 180 NGT, B 200, B 200 CDI, B 200 TURBO	Number of mounting bores: 3; with fastening material	E	'E	'H	CJ1143
------------	--	--	---	----	----	--------

C-CLASS (W202)

03/1993 → 05/2000

Ball Joint	C 180, C 200, C 200 CDI, C 200 D, C 200 Kompressor, C 220, C 220 CDI, C 220 D, C 230, C 230 Kompressor, C 240, C 250 D, C 250 Turbo-D, C 280, C 36 AMG, C 43		E	'E	'H	CJ1028
Tie Rod End	C 180, C 200, C 200 CDI, C 200 D, C 200 Kompressor, C 220, C 220 CDI, C 220 D, C 230, C 230 Kompressor, C 240, C 250 D, C 250 Turbo-D, C 280, C 36 AMG, C 43		E	'E	'H	CTR5497

C-CLASS Estate (S202)

06/1996 → 03/2001











Ball Joint	C 180 T, C 200 T, C 200 T CDI, C 200 T D, C 200 T Kompressor, C 220 T CDI, C 220 T D, C 230 T, C 230 T Kompressor, C 240 T, C 250 T Turbo-D, C 280 T, C 43 AMG		E	'E	'H	CJ1028
Tie Rod End	C 180 T, C 200 T, C 200 T CDI, C 200 T D, C 200 T Kompressor, C 220 T CDI, C 220 T D, C 230 T, C 230 T Kompressor, C 250 T Turbo-D		E	'E	'H	CTR5497
Tie Rod Axle Joint	C 200 T Kompressor		E	'E	'H	RE5782

C-CLASS (W203)

05/2000 → 02/2007

Track Control Arm	C 180, C 180 Kompressor, C 200 CDI, C 200 CGI Kompressor, C 200 Kompressor, C 220 CDI, C 230, C 230 Kompressor, C 240, C 270 CDI, C 280, C 30 CDI AMG, C 32 AMG Kompressor, C 320, C 320 CDI, C 350, C 55 AMG		E	'E		CJ996L
Track Control Arm	C 180, C 180 Kompressor, C 200 CDI, C 200 CGI Kompressor, C 200 Kompressor, C 220 CDI, C 230, C 230 Kompressor, C 240, C 270 CDI, C 280, C 30 CDI AMG, C 32 AMG Kompressor, C 320, C 320 CDI, C 350, C 55 AMG		E		'H	CJ996R
Track Control Arm	C 180, C 180 Kompressor, C 200 CDI, C 200 CGI Kompressor, C 200 Kompressor, C 220 CDI, C 230, C 230 Kompressor, C 240, C 240 4-matic, C 270 CDI, C 280, C 30 CDI AMG, C 32 AMG Kompressor, C 320, C 320 4-matic, C 320 CDI, C 350, C 55 AMG	Material: Aluminium	E	'E		CJ997L
Track Control Arm	C 180, C 180 Kompressor, C 200 CDI, C 200 CGI Kompressor, C 200 Kompressor, C 220 CDI, C 230, C 230 Kompressor, C 240, C 240 4-matic, C 270 CDI, C 280, C 30 CDI AMG, C 32 AMG Kompressor, C 320, C 320 4-matic, C 320 CDI, C 350, C 55 AMG	Material: Aluminium	E		'H	CJ997R
Tie Rod End	C 180, C 180 Kompressor, C 200 CDI, C 200 CGI Kompressor, C 200 Kompressor, C 220 CDI, C 230, C 230 Kompressor, C 240, C 270 CDI, C 280, C 30 CDI AMG, C 32 AMG Kompressor, C 320, C 320 CDI, C 350, C 55 AMG		E	'E		CTR5781L
Rod/Strut, stabiliser	C 180, C 180 Kompressor, C 200 CDI, C 200 CGI Kompressor, C 200 Kompressor, C 220 CDI, C 230, C 230 Kompressor, C 240, C 240 4-matic, C 270 CDI, C 280, C 320, C 320 4-matic, C 320 CDI, C 350	Material: Steel; for vehicles with standard chassis	E	'E	'H	CTR5783
Rod/Strut, stabiliser	C 180, C 180 Kompressor, C 200 CDI, C 200 CGI Kompressor, C 200 Kompressor, C 220 CDI, C 230 Kompressor, C 240, C 240 4-matic, C 270 CDI, C 30 CDI AMG, C 320, C 320 4-matic, C 350 AMG	ch.→A666024, E019386, F593966, R156265; Material: Steel; not for model year: 2005; for vehicles with sports suspension	E	'E	'H	CTR5783

MERCEDES-BENZ

						
CJ1028	CJ1143	CJ996L	CJ996R	CJ997L	CJ997R	CTR5497
Ref.Nr.: 2103330427	Ref.Nr.: 1693330127	Ref.Nr.: 2033301911	Ref.Nr.: 2043302011	Ref.Nr.: 2033300111	Ref.Nr.: 2033303611	Ref.Nr.: 0013307435
						
CTR5781L	CTR5783	RE5782				
Ref.Nr.: 2033303903	Ref.Nr.: 2033302589	Ref.Nr.: 2203380715				

MERCEDES-BENZ

Article Description			Fitting Position	Article No.
---------------------	---	---	------------------	-------------

C-CLASS (W203)

05/2000 → 02/2007

Tie Rod Axle Joint	C 180 , C 180 Kompressor , C 200 CDI , C 200 CGI Kompressor , C 200 Kompressor , C 220 CDI , C 230 Kompressor , C240 , C270 CDI , C32 AMG Kompressor , C 320		E	'E	H	RE5782
--------------------	--	--	---	----	---	--------

C-CLASS Coupe (CL203)

03/2001 → 05/2008

Track Control Arm	C 160 Kompressor , C 180 , C 180 Kompressor , C 200 CDI , C 200 CGI Kompressor , C 200 Kompressor , C 220 CDI , C 230 , C 230 Kompressor , C 30 CDI AMG , C 32 AMG Kompressor , C 320 , C 350		E	'E		CJ996L
Track Control Arm	C 160 Kompressor , C 180 , C 180 Kompressor , C 200 CDI , C 200 CGI Kompressor , C 200 Kompressor , C 220 CDI , C 230 , C 230 Kompressor , C 30 CDI AMG , C 32 AMG Kompressor , C 320 , C 350		E		H	CJ996R
Track Control Arm	C 160 Kompressor , C 180 , C 180 Kompressor , C 200 CDI , C 200 CGI Kompressor , C 200 Kompressor , C 220 , C 220 CDI , C 230 , C 230 Kompressor , C 30 CDI AMG , C 32 AMG Kompressor , C 320 , C 350	Material: Aluminium	E	'E		CJ997L
Track Control Arm	C 160 Kompressor , C 180 , C 180 Kompressor , C 200 CDI , C 200 CGI Kompressor , C 200 Kompressor , C 220 , C 220 CDI , C 230 , C 230 Kompressor , C 30 CDI AMG , C 32 AMG Kompressor , C 320 , C 350	Material: Aluminium	E		H	CJ997R
Tie Rod End	C 160 Kompressor , C 180 , C 180 Kompressor , C 200 CDI , C 200 CGI Kompressor , C 200 Kompressor , C 220 , C 220 CDI , C 230 , C 230 Kompressor , C 30 CDI AMG , C 32 AMG Kompressor , C 320 , C 350		E	'E		CTR5781L
Rod/Strut, stabiliser	C 160 Kompressor , C 180 , C 180 Kompressor , C 200 CDI , C 200 CGI Kompressor , C 200 Kompressor , C 220 CDI , C 230 , C 230 Kompressor , C 320 , C 350	Material: Steel; for vehicles with standard chassis	E	'E	H	CTR5783
Rod/Strut, stabiliser	C 180 , C 180 Kompressor , C 200 Kompressor , C 220 CDI , C 230 Kompressor , C 320	ch.→A436251; Material: Steel; for vehicles with sports suspension	E	'E	H	CTR5783
Tie Rod Axle Joint	C 160 Kompressor , C 180 , C 180 Kompressor , C 200 CDI , C 200 CGI Kompressor , C 200 Kompressor , C 220 , C 220 CDI , C 230 , C 230 Kompressor , C 30 CDI AMG , C 32 AMG Kompressor , C 320 , C 350		E	'E	H	RE5782

C-CLASS T-Model (S203)

03/2001 → 08/2007

Track Control Arm	C 180 , C 180 Kompressor , C 200 CDI , C 200 CGI Kompressor , C 200 Kompressor , C 220 CDI , C 230 , C 230 Kompressor , C 240 , C 270 CDI , C 280 , C 30 CDI AMG , C 32 AMG Kompressor , C 320 , C 320 CDI , C 350 , C 55 AMG		E	'E		CJ996L
Track Control Arm	C 180 , C 180 Kompressor , C 200 CDI , C 200 CGI Kompressor , C 200 Kompressor , C 220 CDI , C 230 , C 230 Kompressor , C 240 , C 270 CDI , C 280 , C 30 CDI AMG , C 32 AMG Kompressor , C 320 , C 320 CDI , C 350 , C 55 AMG		E		H	CJ996R
Track Control Arm	C 180 , C 180 Kompressor , C 200 CDI , C 200 CGI Kompressor , C 200 Kompressor , C 220 CDI , C 230 , C 230 Kompressor , C 240 , C 240 4-matic , C 270 CDI , C 280 , C 30 CDI AMG , C 32 AMG Kompressor , C 320 , C 320 4-matic , C 320 CDI , C 350 , C 55 AMG	Material: Aluminium	E	'E		CJ997L
Track Control Arm	C 180 , C 180 Kompressor , C 200 CDI , C 200 CGI Kompressor , C 200 Kompressor , C 220 CDI , C 230 , C 230 Kompressor , C 240 , C 240 4-matic , C 270 CDI , C 280 , C 30 CDI AMG , C 32 AMG Kompressor , C 320 , C 320 4-matic , C 320 CDI , C 350 , C 55 AMG	Material: Aluminium	E		H	CJ997R
Tie Rod End	C 180 , C 180 Kompressor , C 200 CDI , C 200 CGI Kompressor , C 200 Kompressor , C 220 CDI , C 230 , C 230 Kompressor , C 240 , C 270 CDI , C 280 , C 30 CDI AMG , C 32 AMG Kompressor , C 320 , C 320 CDI , C 350 , C 55 AMG		E	'E		CTR5781L

						
CJ996L	CJ996R	CJ997L	CJ997R	CTR5781L	CTR5783	RE5782
Ref.Nr.: 2033301911	Ref.Nr.: 2043302011	Ref.Nr.: 2033300111	Ref.Nr.: 2033303611	Ref.Nr.: 2033303903	Ref.Nr.: 2033202589	Ref.Nr.: 2203380715

MERCEDES-BENZ

MERCEDES-BENZ

Article Description			Fitting Position	Article No.
---------------------	---	---	------------------	-------------

C-CLASS T-Model (S203)

03/2001 → 08/2007

Rod/Strut, stabiliser	C 180 , C 180 Kompressor , C 200 CDI , C 200 CGI Kompressor , C 200 Kompressor , C 220 CDI , C 230 , C 230 Kompressor , C 240 , C 270 CDI , C 280 , C 320 , C 320 CDI , C 350	Material: Steel; for vehicles with standard chassis	E	'E 'H	CTR5783
Tie Rod Axle Joint	C 180 , C 180 Kompressor , C 200 CDI , C 200 CGI Kompressor , C 200 Kompressor , C 220 CDI , C 230 , C 230 Kompressor , C 240 , C 270 CDI , C 280 , C 30 CDI AMG , C 32 AMG Kompressor , C 320 , C 320 CDI , C 350 , C 55 AMG		E	'E 'H	RE5782

C-CLASS (W204)

01/2007 → 01/2014

Rod/Strut, stabiliser	C 180 CDI , C 180 CGI , C 180 Kompressor , C 200 CDI , C 200 CGI , C 200 Kompressor , C 220 CDI , C 230 , C 250 CDI , C 250 CGI , C 280 , C 300 , C 320 CDI , C 350 , C 350 CDI , C 350 CGI	for vehicles with active stabilizer; Material: Steel; for vehicles with sports suspension	E	'H	CTR6047R
Rod/Strut, stabiliser	C 63 AMG	Material: Steel	E	'H	CTR6047R

C-CLASS Coupe (C204)

06/2011 →

Rod/Strut, stabiliser	C 180 , C 220 CDI , C 250 , C 250 CDI , C 350	for vehicles with active stabilizer; Material: Steel; for vehicles with sports suspension	E	'H	CTR6047R
Rod/Strut, stabiliser	C 63 AMG	Material: Steel	E	'H	CTR6047R

C-CLASS T-Model (S204)

08/2007 → 08/2014

Rod/Strut, stabiliser	C 180 CDI , C 180 CGI , C 180 Kompressor , C 200 CDI , C 200 Kompressor , C 220 CDI , C 230 , C 250 CDI , C 250 CGI , C 280 , C 320 CDI , C 350 , C 350 CDI , C 350 CGI	for vehicles with active stabilizer; Material: Steel; for vehicles with sports suspension	E	'H	CTR6047R
Rod/Strut, stabiliser	C 63 AMG	Material: Steel	E	'H	CTR6047R
Tie Rod Axle Joint	C 180 Kompressor , C 200 CDI , C 230 , C 280 , C 320 CDI , C 350		E	'E 'H	RE5782

CLC-CLASS (CL203)

05/2008 → 06/2011

Track Control Arm	CLC 160 , CLC 180 Kompressor , CLC 200 CDI , CLC 200 Kompressor , CLC 220 CDI , CLC 230 , CLC 350	Material: Aluminium	E	'E	CJ997L
Track Control Arm	CLC 160 , CLC 180 Kompressor , CLC 200 CDI , CLC 200 Kompressor , CLC 220 CDI , CLC 230 , CLC 350	Material: Aluminium	E	'H	CJ997R
Tie Rod End	CLC 160 , CLC 180 Kompressor , CLC 200 CDI , CLC 200 Kompressor , CLC 220 CDI , CLC 230 , CLC 350		E	'E	CTR5781L
Rod/Strut, stabiliser	CLC 160 , CLC 180 Kompressor , CLC 200 CDI , CLC 200 Kompressor , CLC 220 CDI , CLC 230 , CLC 350	Material: Steel; for vehicles with standard chassis	E	'E 'H	CTR5783
Rod/Strut, stabiliser	CLC 180 Kompressor	ch.→A436251; Material: Steel; for vehicles with sports suspension	E	'E 'H	CTR5783

CLK (C208)

06/1997 → 07/2002

Ball Joint	200, 200 Kompressor , 230 Kompressor , 320, 430, 5.4, 55 AMG		E	'E 'H	CJ1028
Tie Rod End	200, 200 Kompressor , 230 Kompressor , 320, 430, 55 AMG		E	'E 'H	CTR5497

CLK Convertible (A208)









03/1998 → 03/2002

Ball Joint	200, 200 Kompressor , 230 Kompressor , 320, 430, 55 AMG		E	'E 'H	CJ1028
Tie Rod End	200, 200 Kompressor , 230 Kompressor , 320, 430, 55 AMG		E	'E 'H	CTR5497

CLK (C209)

06/2002 → 05/2009

Track Control Arm	200 CGI , 200 Kompressor , 220 CDI , 240 , 270 CDI , 280 , 320 , 320 CDI , 350 , 500 , 55 AMG , 63 AMG , CLK DTM AMG		E	'E	CJ996L
-------------------	--	--	---	----	--------

						
CJ1028	CJ996L	CJ997L	CJ997R	CTR5497	CTR5781L	CTR5783
Ref.Nr.: 2103330427	Ref.Nr.: 2033301911	Ref.Nr.: 2033300111	Ref.Nr.: 2033303611	Ref.Nr.: 0013307435	Ref.Nr.: 2033303903	Ref.Nr.: 2033202589
						
CTR6047R	RE5782					
Ref.Nr.: 2043201889	Ref.Nr.: 2203380715					

MERCEDES-BENZ

Article Description			Fitting Position	Article No.
---------------------	---	---	------------------	-------------

CLK (C209)

06/2002 → 05/2009

Track Control Arm	200CGI , 200 Kompressor, 220CDI, 240, 270CDI, 280, 320, 320 CDI, 350, 500, 55 AMG, 63 AMG, CLK DTM AMG		E		H	CJ996R
Track Control Arm	200CGI , 200 Kompressor, 220CDI, 240, 270CDI, 280, 320, 320 CDI, 350, 500, 55 AMG, 63 AMG	Material: Aluminium	E	E		CJ997L
Track Control Arm	200CGI , 200 Kompressor, 220CDI, 240, 270CDI, 280, 320, 320 CDI, 350, 500, 55 AMG, 63 AMG	Material: Aluminium	E		H	CJ997R
Tie Rod End	200CGI , 200 Kompressor, 220CDI, 240, 270CDI, 280, 320, 320 CDI, 350, 500, 55 AMG, 63 AMG, CLK DTM AMG		E	E		CTR5781L
Rod/Strut, stabiliser	200CGI , 200 Kompressor, 220CDI, 240, 270CDI, 280, 320, 320 CDI, 350, 500	Material: Steel; for vehicles with standard chassis	E	E	H	CTR5783

CLK Convertible (A209)

02/2003 → 03/2010

Track Control Arm	CLK 200 Kompressor, CLK 240, CLK 280, CLK 320, CLK 320 CDI, CLK 350, CLK 500, CLK 55 AMG, CLK 63 AMG		E	E		CJ996L
Track Control Arm	CLK 200 Kompressor, CLK 240, CLK 280, CLK 320, CLK 320 CDI, CLK 350, CLK 500, CLK 55 AMG, CLK 63 AMG		E		H	CJ996R
Track Control Arm	CLK 200CGI, CLK 200 Kompressor, CLK 240, CLK 280, CLK 320, CLK 320 CDI, CLK 350, CLK 500, CLK 55 AMG	Material: Aluminium	E	E		CJ997L
Track Control Arm	CLK 200CGI, CLK 200 Kompressor, CLK 240, CLK 280, CLK 320, CLK 320 CDI, CLK 350, CLK 500, CLK 55 AMG	Material: Aluminium	E		H	CJ997R
Tie Rod End	CLK 200 CGI, CLK 200 Kompressor, CLK 240, CLK 280, CLK 320, CLK 320 CDI, CLK 350, CLK 500, CLK 55 AMG, CLK 63 AMG, CLK AMG DTM		E	E		CTR5781L
Rod/Strut, stabiliser	CLK 200 Kompressor, CLK 240, CLK 280, CLK 320, CLK 320 CDI, CLK 350, CLK 500	Material: Steel; for vehicles with standard chassis	E	E	H	CTR5783

CLS (C219)

10/2004 → 02/2011

Ball Joint	CLS 280, CLS 300, CLS 320 CDI, CLS 350, CLS 350 CDI, CLS 350 CGI, CLS 500, CLS 55 AMG, CLS 550, CLS 63 AMG		E	E	H	CJ1193
------------	--	--	---	---	---	--------

COUPE (C123)

03/1977 → 12/1985

Tie Rod End	230 C, 230 CE, 280 C, 280 CE		E	E	H	CTR5172
-------------	------------------------------	--	---	---	---	---------

E-CLASS (W210)











06/1995 → 03/2002

Ball Joint	E 200, E 200 CDI, E 200 D, E 200 Kompressor, E 220 CDI, E 220 D, E 230, E 240, E 250 D, E 250 Turbo-D, E 270 CDI, E 280, E 280 4-matic, E 290 Turbo-D, E 300 D, E 300 Turbo-D, E 320, E 320 4-matic, E 320 CDI, E 36 AMG, E 420, E 430, E		E	E	H	CJ1028
Tie Rod Axle Joint	E 200, E 200 CDI, E 200 D, E 200 Kompressor, E 220 CDI, E 220 D, E 230, E 240, E 250 D, E 250 Turbo-D, E 280, E 290 Turbo-D, E 300 D, E 300 Turbo-D, E 320, E 420, E 430, E 50 AMG, E 55 AMG		E	E	H	RE5444

E-CLASS Estate (S210)

06/1996 → 03/2003

Ball Joint	E 200 T, E 200 T Kompressor, E 220 T CDI, E 230 T, E 240 T, E 250 TD, E 250 T Turbo-D, E 270 T CDI, E 280 T, E 280 T 4-matic, E 290 T Turbo-D, E 300 T Turbo-D, E 320 T, E 320 T 4-matic, E 320 T CDI, E 420 T, E 430 T, E 430 T 4-matic, E		E	E	H	CJ1028
Tie Rod Axle Joint	E 200 T, E 200 T Kompressor, E 220 T CDI, E 230 T, E 240 T, E 250 TD, E 250 T Turbo-D, E 280 T, E 280 T 4-matic, E 290 T Turbo-D, E 300 T Turbo-D, E 320 T, E 420 T, E 430 T, E 55 T AMG		E	E	H	RE5444

						
CJ1028	CJ1193	CJ996L	CJ996R	CJ997L	CJ997R	CTR5172
Ref.Nr.: 2103330427	Ref.Nr.: 2203330127	Ref.Nr.: 2033301911	Ref.Nr.: 2043302011	Ref.Nr.: 2033300111	Ref.Nr.: 2033303611	Ref.Nr.: 1233380210
						
CTR5781L	CTR5783	RE5444				
Ref.Nr.: 2033303903	Ref.Nr.: 2033202589	Ref.Nr.: 2103380415				

MERCEDES-BENZ

Article Description			Fitting Position	Article No.
---------------------	---	---	------------------	-------------

E-CLASS (W211)

03/2002 → 12/2008

Ball Joint	3.5 4-matic, E 240 4-matic, E 280 4-matic, E 280 CDI 4-matic, E 320 4-matic, E 320 CDI 4-matic, E 350 4-matic, E 500 4-matic		E	'E	'H	CJ1028
Ball Joint	E 200 CDI, E 200 CGI, E 200 Kompressor, E 220 CDI, E 230, E 240, E 240 4-matic, E 270 CDI, E 280, E 280 CDI, E 300 BlueTEC, E 320, E 320 4-matic, E 320 CDI, E 350, E 350 CGI, E 400 CDI, E 420 CDI, E 500, E 500 4-matic, E 55 AMG Kompresso		E	'E	'H	CJ1193
Tie Rod Axle Joint	E 200 CDI, E 200 CGI, E 200 Kompressor, E 220 CDI, E 240, E 240 4-matic, E 270 CDI, E 280, E 280 4-matic, E 280 CDI, E 280 CDI 4-matic, E 320, E 320 4-matic, E 320 CDI, E 320 CDI 4-matic, E 350, E 350 4-matic, E 400 CDI, E 420 CDI, E 500,		E	'E	'H	RE5782

E-CLASS T-Model (S211)

03/2003 → 07/2009

Ball Joint	E 240 T 4-matic, E 280 T 4-matic, E 280 T CDI 4-matic, E 320 T 4-matic, E 320 T CDI 4-matic, E 350 T 4-matic, E 500 T 4-matic		E	'E	'H	CJ1028
Ball Joint	350 CGI, E 200 CDI, E 200 Kompressor, E 200 T Kompressor, E 220 CDI, E 220 T CDI, E 230 T, E 240 T, E 240 T 4-matic, E 270 T CDI, E 280 T, E 280 T CDI, E 320 T, E 320 T 4-matic, E 320 T CDI, E 350 T, E 500 T, E 500 T 4-matic, E 55 T AMG K		E	'E	'H	CJ1193

E-CLASS Convertible (A207)

01/2010 →

Rod/Strut, stabiliser	E 200 CGI, E 220 CDI, E 250 CDI, E 250 CGI, E 300, E 350, E 350 CDI, E 350 CGI, E 500, E 550 CGI	for vehicles with active stabilizer; Material: Steel; for vehicles with sports suspension	E		'H	CTR6047R
-----------------------	--	---	---	--	----	----------

E-CLASS Coupe (C207)

01/2009 →

Rod/Strut, stabiliser	E 200 CGI, E 220 CDI, E 250 CDI, E 250 CGI, E 300, E 350, E 350 CDI, E 350 CGI, E 500, E 550 CGI	for vehicles with active stabilizer; Material: Steel; for vehicles with sports suspension	E		'H	CTR6047R
-----------------------	--	---	---	--	----	----------

Saloon (W123)

01/1976 → 12/1985

Tie Rod End	200, 200 D, 220 D, 230, 230 E, 240 D, 250, 280, 280 E, 300 D		E	'E	'H	CTR5172
-------------	--	--	---	----	----	---------

S-CLASS (W220)

10/1998 → 08/2005

Ball Joint	S 350 4-matic, S 430 4-matic, S 500 4-matic		E	'E	'H	CJ1028
Ball Joint	S 280, S 320, S 320 CDI, S 350, S 350 4-matic, S 400 CDI, S 430, S 430 4-matic, S 500, S 500 4-matic, S 55 AMG, S 55 AMG Kompressor, S 600, S 63 AMG, S 65 AMG		E	'E	'H	CJ1193
Tie Rod Axle Joint	S 280, S 320, S 320 CDI, S 350, S 350 4-matic, S 400 CDI, S 430, S 430 4-matic, S 500, S 500 4-matic, S 55 AMG, S 55 AMG Kompressor, S 600, S 63 AMG, S 65 AMG		E	'E	'H	RE5782

S-CLASS Coupe (C215)

03/1999 → 03/2006

Ball Joint	CL 500, CL 55 AMG, CL 55 AMG Kompressor, CL 600, CL 63 AMG, CL 65 AMG		E	'E	'H	CJ1193
Tie Rod Axle Joint	CL 500, CL 55 AMG, CL 63 AMG		E	'E	'H	RE5782

S-CLASS (W221)





12/2005 → 12/2013

Tie Rod Axle Joint	S 600		E	'E	'H	RE5782
--------------------	-------	--	---	----	----	--------



SL (R230)

10/2001 → 01/2012











Ball Joint	280, 300, 350, 500, 55 AMG, 55 AMG Kompressor, 600, 63 AMG, 65 AMG		E	'E	'H	CJ1193
------------	--	--	---	----	----	--------

				
CJ1028	CJ1193	CTR5172	CTR6047R	RE5782
Ref.Nr.: 2103330427	Ref.Nr.: 2203330127	Ref.Nr.: 1233380210	Ref.Nr.: 2043201889	Ref.Nr.: 2203380715

MERCEDES-BENZ

Article Description			Fitting Position	Article No.
SL (R230)				10/2001 → 01/2012
Tie Rod Axle Joint	500, 55 AMG		E 'E 'H	RE5782
SLK (R170)				09/1996 → 04/2004
Ball Joint	200, 200 Kompressor , 230 Kompressor , 32 AMG Kompressor , 320		E 'E 'H	CJ1028
Tie Rod End	32 AMG Kompressor , 320		E 'E 'H	CTR5497
SLK (R171)				03/2004 → 02/2011
Track Control Arm	200 Kompressor , 280, 350, 55 AMG		E 'E	CJ996L
Track Control Arm	200 Kompressor , 280, 350, 55 AMG		E 'H	CJ996R
Track Control Arm	200 Kompressor , 280, 300, 350	Material: Aluminium	E 'E	CJ997L
Track Control Arm	200 Kompressor , 280, 300, 350	Material: Aluminium	E 'H	CJ997R
Tie Rod End	200 Kompressor , 280, 300, 350, 55 AMG		E 'E	CTR5781L
SPRINTER 2-t Bus (901, 902)				02/1995 → 05/2006
Tie Rod End	208CDI, 208D, 210D, 211 CDI, 212D, 213 CDI, 214, 214 NGT, 216 CDI		E 'E 'H	CTR5542
SPRINTER 2-t Box (901, 902)				02/1995 → 05/2006
Tie Rod End	208CDI, 208D, 210D, 211 CDI, 212D, 213 CDI, 214, 214 NGT, 216 CDI		E 'E 'H	CTR5542
SPRINTER 2-t Platform/Chassis (901, 902)				01/1995 → 05/2006
Tie Rod End	208CDI, 208D, 210D, 211 CDI, 212D, 213 CDI, 214, 214 NGT, 216 CDI		E 'E 'H	CTR5542
SPRINTER 3-t Bus (903)				02/1995 → 05/2006
Tie Rod End	2.9TDI, 308 CDI, 308D, 308E, 310D 4x4, 311 CDI, 311 CDI 4x4, 312 D 2.9, 312 D 2.9 4x4, 313 CDI, 313 CDI 4x4, 314, 314 4x4, 314 NGT, 316 CDI, 316 CDI 4x4		E 'E 'H	CTR5542
SPRINTER 3-t Box (903)				02/1995 → 05/2006
Tie Rod End	308CDI, 308D2.3, 310D2.9, 311 CDI, 311 CDI 4x4, 312D 2.9, 312D 2.9 4x4, 313 CDI, 313 CDI 4x4, 314, 314 4x4, 314 NGT, 316 CDI, 316 CDI 4x4		E 'E 'H	CTR5542
SPRINTER 3-t Platform/Chassis (903)				02/1995 → 05/2006
Tie Rod End	308CDI, 308D2.3, 310D2.9, 311 CDI, 311 CDI 4x4, 312D 2.9, 313 CDI, 313 CDI 4x4, 314, 314 4x4, 314 NGT, 316CDI, 316 CDI 4x4		E 'E 'H	CTR5542
SPRINTER 3-t Bus (906)				06/2006 →
Tie Rod End	210CDI, 211 CDI, 213 CDI, 215 CDI, 216, 216 CDI, 224		E 'E 'H	CTR5927
Tie Rod Axle Joint	210CDI, 211 CDI, 213 CDI, 215 CDI, 216, 216 CDI, 224		E 'E 'H	RE5928
SPRINTER 3-t Box (906)				06/2006 →
Tie Rod End	209 CDI, 210 CDI, 211 CDI, 213 CDI, 215 CDI, 216, 216 CDI, 218 CDI, 219 CDI, 224		E 'E 'H	CTR5927
Tie Rod Axle Joint	209 CDI, 210 CDI, 211 CDI, 213 CDI, 215 CDI, 216, 216 CDI, 218 CDI, 219 CDI, 224		E 'E 'H	RE5928

MERCEDES-BENZ

						
CJ1028	CJ996L	CJ996R	CJ997L	CJ997R	CTR5497	CTR5542
Ref.Nr.: 2103330427	Ref.Nr.: 2033301911	Ref.Nr.: 2043302011	Ref.Nr.: 2033300111	Ref.Nr.: 2033303611	Ref.Nr.: 0013307435	Ref.Nr.: 2D0422811
						
CTR5781L	CTR5927	RE5782	RE5928			
Ref.Nr.: 2033303903	Ref.Nr.: 90610481003	Ref.Nr.: 2203380715	Ref.Nr.: 90610551003			

MERCEDES-BENZ

Article Description			Fitting Position	Article No.
---------------------	---	---	------------------	-------------

SPRINTER 3-t Platform/Chassis (906)

06/2006 →

Tie Rod End	209 CDI, 210 CDI, 211 CDI, 213 CDI, 215 CDI, 216, 216 CDI, 218 CDI, 219 CDI, 224		E	'E	'H	CTR5927
Tie Rod Axle Joint	209 CDI, 210 CDI, 211 CDI, 213 CDI, 215 CDI, 216, 216 CDI, 218 CDI, 219 CDI, 224		E	'E	'H	RE5928

SPRINTER 3,5-t Bus (906)

06/2006 →

Tie Rod End	310 CDI, 311 CDI, 311 CDI 4x4, 313 CDI, 313 CDI 4x4, 315 CDI, 315 CDI 4x4, 316, 316 CDI, 316 CDI 4x4, 316 LGT, 316 NGT, 318 CDI, 318 CDI 4x4, 319 CDI, 319 CDI 4x4, 324		E	'E	'H	CTR5927
Tie Rod Axle Joint	310 CDI, 311 CDI, 311 CDI 4x4, 313 CDI, 313 CDI 4x4, 315 CDI, 315 CDI 4x4, 316, 316 CDI, 316 CDI 4x4, 316 LGT, 316 NGT, 318 CDI, 318 CDI 4x4, 319 CDI, 319 CDI 4x4, 324		E	'E	'H	RE5928

SPRINTER 3,5-t Box (906)

06/2006 →

Tie Rod End	309 CDI, 310 CDI, 311 CDI, 311 CDI 4x4, 313 CDI, 313 CDI 4x4, 315 CDI, 315 CDI 4x4, 316, 316 CDI, 316 CDI 4x4, 316 LGT, 316 NGT, 318 CDI, 318 CDI 4x4, 319 CDI, 319 CDI 4x4, 324		E	'E	'H	CTR5927
Tie Rod Axle Joint	309 CDI, 310 CDI, 311 CDI, 311 CDI 4x4, 313 CDI, 313 CDI 4x4, 315 CDI, 315 CDI 4x4, 316, 316 CDI, 316 CDI 4x4, 316 LGT, 316 NGT, 318 CDI, 318 CDI 4x4, 319 CDI, 319 CDI 4x4, 324		E	'E	'H	RE5928

SPRINTER 3,5-t Platform/Chassis (906)

06/2006 →

Tie Rod End	309 CDI, 310 CDI, 311 CDI, 311 CDI 4x4, 313 CDI, 313 CDI 4x4, 315 CDI, 315 CDI 4x4, 316, 316 CDI, 316 CDI 4x4, 316 LGT, 316 NGT, 318 CDI, 318 CDI 4x4, 319 CDI, 319 CDI 4x4, 324		E	'E	'H	CTR5927
Tie Rod Axle Joint	309 CDI, 310 CDI, 311 CDI, 311 CDI 4x4, 313 CDI, 313 CDI 4x4, 315 CDI, 315 CDI 4x4, 316, 316 CDI, 316 CDI 4x4, 316 LGT, 316 NGT, 318 CDI, 318 CDI 4x4, 319 CDI, 319 CDI 4x4, 324		E	'E	'H	RE5928

SPRINTER 4-t Bus (904)

02/1996 → 05/2006

Tie Rod End	408 CDI, 411 CDI, 413 CDI, 414, 416 CDI		E	'E	'H	CTR5542
-------------	---	--	---	----	----	---------

SPRINTER 4-t Box (904)

02/1996 → 05/2006

Tie Rod End	408 CDI, 408 D, 410 D, 410 D 4x4, 411 CDI, 411 CDI 4x4, 412 D, 412 D 4x4, 413 CDI, 413 CDI 4x4, 414, 414 4x4, 416 CDI, 416 CDI 4x4		E	'E	'H	CTR5542
-------------	--	--	---	----	----	---------

SPRINTER 4-t Platform/Chassis (904)

02/1996 → 05/2006



Tie Rod End	408 CDI, 408 D, 410 D, 410 D 4x4, 411 CDI, 411 CDI 4x4, 412 D, 412 D 4x4, 413 CDI, 413 CDI 4x4, 414, 414 4x4, 416 CDI, 416 CDI 4x4		E	'E	'H	CTR5542
-------------	--	--	---	----	----	---------

SPRINTER 4,6-t Box (906)

06/2006 →

Tie Rod End	411 CDI, 413 CDI, 415 CDI, 416 CDI, 418 CDI, 419 CDI, 42		E	'E	'H	CTR5927
Tie Rod Axle Joint	411 CDI, 413 CDI, 415 CDI, 416 CDI, 418 CDI, 419 CDI, 42		E	'E	'H	RE5928

MERCEDDES-BENZ

		
CTR5542	CTR5927	RE5928
Ref.Nr.: 2D0422811	Ref.Nr.: 90610481003	Ref.Nr.: 90610551003

Article Description			Fitting Position	Article No.
---------------------	---	---	------------------	-------------

SPRINTER 4,6-t Platform/Chassis (906)

06/2006 →

Tie Rod End	411 CDI, 413 CDI, 415 CDI, 416 CDI, 418 CDI, 419 CDI, 424		E	'E	'H	CTR5927
Tie Rod Axle Joint	411 CDI, 413 CDI, 415 CDI, 416 CDI, 418 CDI, 419 CDI, 424		E	'E	'H	RE5928

SPRINTER 5-t Box (906)

06/2006 →



Tie Rod End	509 CDI, 510 CDI, 511 CDI, 511 CDI 4x4, 513 CDI, 513 CDI 4x4, 515 CDI, 515 CDI 4x4, 516 CDI, 516 CDI 4x4, 518 CDI, 518 CDI 4x4, 519 CDI, 519 CDI 4x4, 524		E	'E	'H	CTR5927
Tie Rod Axle Joint	509 CDI, 510 CDI, 511 CDI, 511 CDI 4x4, 513 CDI, 513 CDI 4x4, 515 CDI, 515 CDI 4x4, 516 CDI, 516 CDI 4x4, 518 CDI, 518 CDI 4x4, 519 CDI, 519 CDI 4x4, 524		E	'E	'H	RE5928

SPRINTER 5-t Platform/Chassis (906)

06/2006 →

Tie Rod End	509 CDI, 510 CDI, 511 CDI, 511 CDI 4x4, 513 CDI, 513 CDI 4x4, 515 CDI, 515 CDI 4x4, 516, 516 CDI, 516 CDI 4x4, 516NGT, 518 CDI, 518 CDI 4x4, 519 CDI, 519 CDI 4x4, 524		E	'E	'H	CTR5927
Tie Rod Axle Joint	509 CDI, 510 CDI, 511 CDI, 511 CDI 4x4, 513 CDI, 513 CDI 4x4, 515 CDI, 515 CDI 4x4, 516, 516 CDI, 516 CDI 4x4, 516NGT, 518 CDI, 518 CDI 4x4, 519 CDI, 519 CDI 4x4, 524		E	'E	'H	RE5928

	
CTR5927	RE5928
Ref.Nr.: 90610481003	Ref.Nr.: 90610551003

Article Description			Fitting Position	Article No.
MINI (R56)			03/2008 → 11/2013	
Rod/Strut, stabiliser	John Cooper Works	Equipment Variant: C-CUP, CHALLENGE	E	E H
				CTR5380

	
CTR5380	
Ref.Nr.: 31351124380	

Article Description			Fitting Position	Article No.
---------------------	---	---	------------------	-------------

CHALLENGER I (K90)

11/1998 → 10/2003

Ball Joint	2.5 TD , 3.0 V6		E	'E	'H	CJ904
Ball Joint	2.5 TD , 3.0 V6		E	'E		CJ961L
Ball Joint	2.5 TD , 3.0 V6		E		'H	CJ961R
Tie Rod End	2.5 TD , 2.8 TDi, 3.0 V6		E	'E	'H	CTR5556
Tie Rod End	2.5 TD , 3.0 V6		E	'E	'H	CTR5557

COLT HIGH LINE RODEO 2X4

01/1998 → 12/2009

Ball Joint	2.0,2.4,2.5,2.8D,2.8TDI	Upper	E	'E	'H	CJ904
Ball Joint	2.0,2.4,2.5,2.8D,2.8TDI	Hi-Rider Lower	E	'E		CJ961L
Ball Joint	2.0,2.4,2.5,2.8D,2.8TDI	Hi-Rider Lower	E		'H	CJ961R
Tie Rod End	2.0,2.4,2.5,2.8D,2.8TDI	Hi Rider Inner	E	'E	'H	CTR5556
Tie Rod End	2.0,2.4,2.5,2.8D,2.8TDI	Hi-Rider Outer	E	'E	'H	CTR5557

COLT HIGH LINE RODEO 4X4

01/1998 → 12/2009

Ball Joint	2.0,2.4,2.5,2.8D,2.8TDI	Upper	E	'E	'H	CJ904
Ball Joint	2.0,2.4,2.5,2.8D,2.8TDI	Hi-Rider Lower	E	'E		CJ961L
Ball Joint	2.0,2.4,2.5,2.8D,2.8TDI	Hi-Rider Lower	E		'H	CJ961R
Tie Rod End	2.0,2.4,2.5,2.8D,2.8TDI	Hi Rider Inner	E	'E	'H	CTR5556
Tie Rod End	2.0,2.4,2.5,2.8D,2.8TDI	Hi-Rider Outer	E	'E	'H	CTR5557

PAJERO/SHOGUN (L04_G, L14_G)

11/1988 → 12/1991

Ball Joint	2.5 TD		E		'H	CJ961R
Tie Rod End	2.5 TD , 3.0 V6	01/1990 →	E	'E	'H	CTR5556
Tie Rod End	2.5 TD , 3.0 V6	01/1990 →	E	'E	'H	CTR5557

PAJERO/SHOGUN (L04_G, L14_G)

11/1988 → 12/1991

Ball Joint	2.5 TD		E	'E		CJ961L
------------	--------	--	---	----	--	--------

PAJERO/SHOGUN Mk II Open Off-Road Vehicle (L04_G)





01/1983 → 11/1990

Ball Joint	2.5 TD		E	'E		CJ961L
Ball Joint	2.5 TD		E		'H	CJ961R
Tie Rod End	2.5 TD , 2.6	01/1990 →	E	'E	'H	CTR5556
Tie Rod End	2.5 TD , 2.6	01/1990 →	E	'E	'H	CTR5557



PAJERO/SHOGUN Mk II (V3_W, V2_W, V4_W)

12/1990 → 10/1999

Ball Joint	2.5TD4x4, 2.8TD, 3.0V624V, 3.0V64x4, 3.5V624V		E	'E	'H	CJ904
Ball Joint	2.4, 2.5TD4x4, 2.8TD, 3.0V624V, 3.0V64x4, 3.5V624V	for OE: MB831037	E	'E		CJ961L
Ball Joint	2.4, 2.5TD4x4, 2.8TD, 3.0V624V, 3.0V64x4, 3.5V624V	for OE: MB831038	E		'H	CJ961R
Tie Rod End	2.4, 2.5TD4x4, 2.8TD, 3.0V624V, 3.0V64x4, 3.5V624V		E	'E	'H	CTR5556
Tie Rod End	2.4, 2.5TD4x4, 2.8TD, 3.0V624V, 3.0V64x4, 3.5V624V		E	'E	'H	CTR5557

				
CJ904	CJ961L	CJ961R	CTR5556	CTR5557
Ref.Nr.: MB860830	Ref.Nr.: MR296269	Ref.Nr.: MR296270	Ref.Nr.: MB831044	Ref.Nr.: MB831043

mitsubishi

Article Description			Fitting Position	Article No.
PAJERO/SHOGUN Mk II Open Off-Road Vehicle (V2_W, V4_W)			12/1990 → 04/2000	
Tie Rod End	1.8 GDI, 2.4 , 2.5 TD , 3.0 V6 , 3.0 V6 24V		E	'E 'H CTR5556
Tie Rod End	1.8 GDI, 2.4 , 2.5 TD , 3.0 V6 , 3.0 V6 24V		E	'E 'H CTR5557
PAJERO/SHOGUN Mk II Open Off-Road Vehicle (V2_W, V4_W)			12/1990 → 04/2000	
Ball Joint	2.5 TD , 3.0 V6 , 3.0 V6 24V		E	'E 'H CJ904
Ball Joint	1.8 GDI, 2.4 , 2.5 TD , 3.0 V6 , 3.0 V6 24V	for OE: MB831037	E	'E CJ961L
PAJERO/SHOGUN Mk II Open Off-Road Vehicle (V2_W, V4_W)			12/1990 → 04/2000	
Ball Joint	1.8 GDI, 2.4 , 2.5 TD , 3.0 V6 , 3.0 V6 24V	for OE: MB831038	E	'H CJ961R
PAJERO/SHOGUN Mk III Open Off-Road Vehicle (V6_W, V7_W)			04/2000 → 12/2006	
Ball Joint	2.5 TDi		E	'E 'H CJ904
Ball Joint	2.5 TDi		E	'E CJ961L
Ball Joint	2.5 TDi		E	'H CJ961R
TRITON 2X4/4X4			01/2007 →	
Ball Joint	2.4MPI,2.5DI-D,3.5	Upper	E	'E 'H CJ904
Ball Joint	2.4MPI,2.5DI-D,3.5	Lower Left	E	'E CJ961L
Ball Joint	2.4MPI,2.5DI-D,3.5	Lower Right	E	'H CJ961R

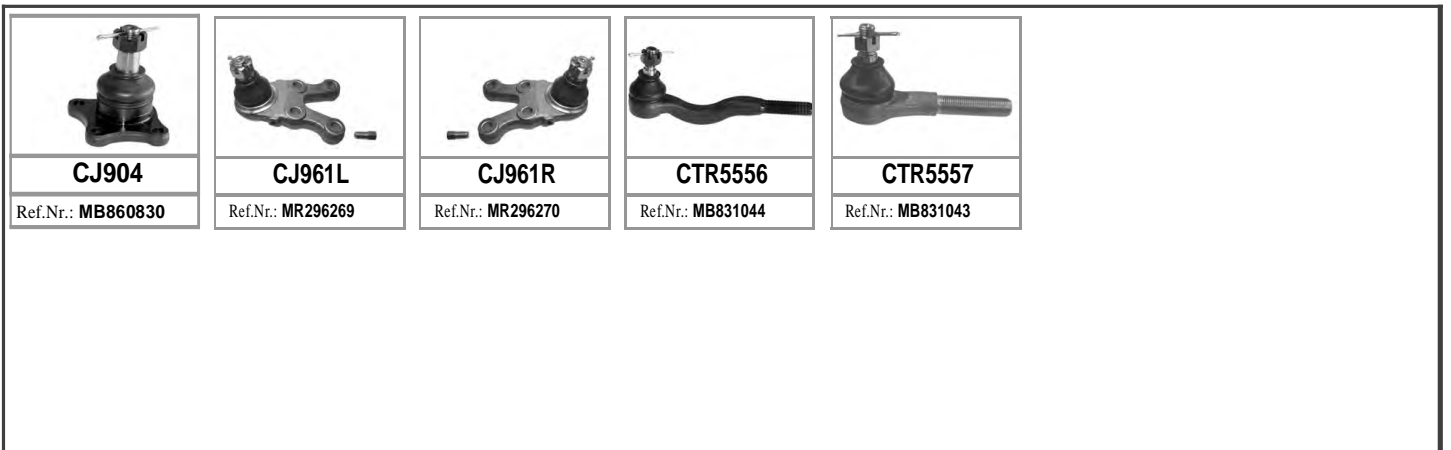

Article Description			Fitting Position	Article No.
---------------------	---	---	------------------	-------------

1 TONNER/HARDBODY 2X4

01/1988 → 12/1998

Ball Joint	1.6,1.8,2.0,2.5,2.7	2X4 Lower	E	'E 'H	CJ912
Tie Rod End	1.6,1.8,2.0,2.5,2.7	Outer	E	'E 'H	CTR5309
Tie Rod End	1.6,1.8,2.0,2.5,2.7	Inner	E	'E 'H	CTR5310

120Y,140Y SEDAN

01/1975 → 12/1980

Tie Rod End	1200,1400	Inner	E	'E	CTR1366L
Tie Rod End	1200,1400	Inner	E	'H	CTR1366R
Tie Rod End	1200,1400	Outer	E	'E	CTR1367L
Tie Rod End	1200,1400	Outer	E	'H	CTR1367R

300 ZX (Z31)

01/1984 → 10/1990

Rod/Strut, stabiliser	3.0, 3.0 Turbo		E	'E 'H	CTR5559
-----------------------	----------------	--	---	-------	---------

720

01/1980 → 12/1988

Tie Rod End	1.8 TRACKER	Outer	E	'E 'H	CTR5309
-------------	-------------	-------	---	-------	---------

1400 CHAMP PICKUP

01/1980 → 12/2008

Ball Joint	1200,1400		E	'E 'H	CJ787
Tie Rod End	1200,1400	Inner		'E	CTR1366L
Tie Rod End	1200,1400	Inner		'H	CTR1366R
Tie Rod End	1200,1400	Outer	E	'E	CTR1367L
Tie Rod End	1200,1400	Outer	E	'H	CTR1367R

						
CJ787	CJ912	CTR1367L	CTR1367R	CTR5309	CTR5310	CTR5559
Ref.Nr.: 40160B1001	Ref.Nr.: 4016001G00	Ref.Nr.: 48640H1001	Ref.Nr.: 48520H1001	Ref.Nr.: 4852131G25	Ref.Nr.: 4852101G25	Ref.Nr.: 54618D5000

NISSAN

Article Description			Fitting Position	Article No.
---------------------	---	---	------------------	-------------

ALMERA Mk II (N16)

07/2000 →

Rod/Strut, stabiliser	1.5, 1.5 dCi, 1.8, 2.2 dCi, 2.2 Di	Material: Steel; with rubber mounting	E	'E	'H	CTR5682
-----------------------	------------------------------------	---------------------------------------	---	----	----	---------

ALMERA Mk II (N16)

01/2000 →

Rod/Strut, stabiliser	1.5, 1.5 dCi, 1.8, 2.2 dCi, 2.2 Di	Material: Steel; with rubber mounting	E	'E	'H	CTR5682
-----------------------	------------------------------------	---------------------------------------	---	----	----	---------

GRAND LIVINA

01/2008 →

Tie Rod Axle Joint	1.6 ACENTA, VISIA, X-GEAR		E	'E	'H	RE5990
--------------------	---------------------------	--	---	----	----	--------

GRAND LIVINA

01/2008 →

Track Control Arm	1.6 ACENTA, VISIA, X-GEAR		E		'H	CJ299R
-------------------	---------------------------	--	---	--	----	--------

GRAND LIVINA

01/2008 →

Track Control Arm	1.6 ACENTA, VISIA, X-GEAR		E	'E		CJ299L
-------------------	---------------------------	--	---	----	--	--------

HARDBODY 2X4 QW/D22

01/1998 → 12/2001









Ball Joint	2.0,SL,2.4,SL,2.7,3.0,SL,3.2 SE	2X4 Upper	E	'E	'H	CJ877
Ball Joint	2.0,SL,2.4,SL,2.7,3.0,SL,3.2 SE	2X4 Lower	E	'E	'H	CJ912
Tie Rod End	2.0,SL,2.4,SL,2.7,3.0,SL,3.2 SE	Outer STD Body	E	'E	'H	CTR5600
Tie Rod End	2.0,SL,2.4,SL,2.7,3.0,SL,3.2 SE	2X4 Inner	E	'E	'H	CTR5601

HARDBODY 4X4 QW244/D22

01/1998 → 12/2010

Ball Joint	2.0,SL,2.4,SL,2.7,3.0,SL,3.2 SE	Upper	E	'E	'H	CJ877
Ball Joint	2.0,SL,2.4,SL,2.7,3.0,SL,3.2 SE	Lower	E	'E	'H	CJ912
Tie Rod End	2.0,SL,2.4,SL,2.7,3.0,SL,3.2 SE	Outer STD Body	E	'E	'H	CTR5600
Tie Rod End	2.0,SL,2.4,SL,2.7,3.0,SL,3.2 SE	Hi Rider 4X4 Inner	E	'E	'H	CTR5699
Tie Rod End	2.0,SL,2.4,SL,2.7,3.0,SL,3.2 SE	Hi Rider 4X4 Outer	E	'E	'H	CTR5700

NISSAN

						
CJ299L	CJ299R	CJ877	CJ912	CTR5601	CTR5682	CTR5699
Ref.Nr.: 8200744091	Ref.Nr.: 8200744092	Ref.Nr.:	Ref.Nr.: 4016001G00	Ref.Nr.: 485212S425	Ref.Nr.: 546184M400	Ref.Nr.: 485703S500
						
CTR5700	RE5990					
Ref.Nr.: 485200W025	Ref.Nr.: 485213U025					

Article Description			Fitting Position	Article No.
---------------------	---	---	------------------	-------------

HARDBODY D22 2X4

01/2008 →

Ball Joint	2.0 I SL 2,7D,3.0TD	Upper	E	'E	'H	CJ877
Ball Joint	2.0 I SL 2,7D,3.0TD	Lower	E	'E	'H	CJ912
Tie Rod End	2.0 I SL 2,7D,3.0TD	Outer STD Body	E	'E	'H	CTR5600
Tie Rod End	2.0 I SL 2,7D,3.0TD	Inner	E	'E	'H	CTR5601

HARDBODY D22 HI-RIDER/4X4

01/2008 →

Ball Joint	2.4I,2,7D,3.2 SL,3.3I	Lower	E	'E	'H	CJ912
Tie Rod End	2.4I,2,7D,3.2 SL,3.3I	Inner	E	'E	'H	CTR5699
Tie Rod End	2.4I,2,7D,3.2 SL,3.3I	Outer	E	'E	'H	CTR5700

HARDBODY D22 HI-RIDER/4X4

01/2008 →

Ball Joint	2.4I,2,7D,3.2 SL,3.3I	Upper	E	'E	'H	CJ877
------------	-----------------------	-------	---	----	----	-------

HARDBODY QW244/D22 2X4

01/2001 → 12/2008

Ball Joint	2.0 I SL 2,7D,3.0TD	Upper	E	'E	'H	CJ877
Tie Rod End	2.0 I SL 2,7D,3.0TD	Inner	E	'E	'H	CTR5601

HARDBODY QW244/D22 HI RIDER

01/2001 → 12/2008

Ball Joint	2.4I,2,7D,3.2 SL,3.3I	Upper	E	'E	'H	CJ877
Ball Joint	2.4I,2,7D,3.2 SL,3.3I	Lower	E	'E	'H	CJ912
Tie Rod End	2.4I,2,7D,3.2 SL,3.3I	Inner	E	'E	'H	CTR5699
Tie Rod End	2.4I,2,7D,3.2 SL,3.3I	Outer	E	'E	'H	CTR5700

				
CJ877	CJ912	CTR5601	CTR5699	CTR5700
Ref.Nr.:	Ref.Nr.: 4016001 G00	Ref.Nr.: 485212S425	Ref.Nr.: 485703S500	Ref.Nr.: 485200W025

Article Description			Fitting Position	Article No.
---------------------	---	---	------------------	-------------

HARDBODY/NP300 D25

01/2008 →

Ball Joint	2.4i,2.5TDI,S,SE	Upper	E	'E	'H	CJ877
Ball Joint	2.4i,2.5TDI,S,SE	Lower	E	'E	'H	CJ912
Tie Rod End	2.4i,2.5TDI,S,SE	Outer STD Body	E	'E	'H	CTR5600
Tie Rod End	2.4i,2.5TDI,S,SE	Inner	E	'E	'H	CTR5601
Tie Rod End	2.4i,2.5TDI,S,SE	Hi Rider 4X4 Inner	E	'E	'H	CTR5699
Tie Rod End	2.4i,2.5TDI,S,SE	Hi Rider 4X4 Outer	E	'E	'H	CTR5700

LIVINA

01/2008 →

Track Control Arm	1.6 ACENTA,VISIA,X-GEAR		E	'E		CJ299L
Track Control Arm	1.6 ACENTA,VISIA,X-GEAR		E		'H	CJ299R
Tie Rod Axle Joint	1.6 ACENTA,VISIA,X-GEAR		E	'E	'H	RE5990

MAXIMA III (J30)



10/1988 → 06/1994

Rod/Strut, stabiliser	3.0 i		E	'E	'H	CTR5559
-----------------------	-------	--	---	----	----	---------

MICRA

01/2005 → 12/2006

Control Arm-Trailing Arm Bush	1.4 COMFORT,ELEGANCE,SEACCENTA,VISIA1,5CDI		E	'E	'H	BS8147
Tie Rod End	1.4 COMFORT,ELEGANCE,SEACCENTA,VISIA1,5CDI		E	'E		CTR5726L
Tie Rod End	1.4 COMFORT,ELEGANCE,SEACCENTA,VISIA1,5CDI		E		'H	CTR5726R
Rod/Strut, stabiliser	1.4 COMFORT,ELEGANCE,SEACCENTA,VISIA1,5CDI		E	'E	'H	CTR5770

						
BS8147	CJ299L	CJ299R	CJ877	CJ912	CTR5559	CTR5601
Ref.Nr.: 54501BC41A	Ref.Nr.: 8200744091	Ref.Nr.: 8200744092	Ref.Nr.:	Ref.Nr.: 4016001G00	Ref.Nr.: 54618D5000	Ref.Nr.: 485212S425
						
CTR5699	CTR5700	CTR5726L	CTR5726R	CTR5770	RE5990	
Ref.Nr.: 485703S500	Ref.Nr.: 485200W025	Ref.Nr.: 7701476760	Ref.Nr.: 7701475843	Ref.Nr.: 8200127308	Ref.Nr.: 485213U025	

Article Description			Fitting Position	Article No.
---------------------	---	---	------------------	-------------

MICRA

01/2005 → 12/2006

Control Arm-/Trailing Arm Bush	1.4 COMFORT,ELEGANCE,SEACCENTA,VISIA1,5CDI		E	'E 'H	BS8218
--------------------------------	--	--	---	-------	--------

MICRA C+C

01/2005 → 12/2006

Control Arm-/Trailing Arm Bush	1.4 COMFORT,ELEGANCE,SEACCENTA,VISIA1,5CDI		E	'E 'H	BS8147
Control Arm-/Trailing Arm Bush	1.4 COMFORT,ELEGANCE,SEACCENTA,VISIA1,5CDI		E	'E 'H	BS8218
Tie Rod End	1.4 COMFORT,ELEGANCE,SEACCENTA,VISIA1,5CDI		E	'E	CTR5726L
Tie Rod End	1.4 COMFORT,ELEGANCE,SEACCENTA,VISIA1,5CDI		E	'H	CTR5726R
Rod/Strut, stabiliser	1.4 COMFORT,ELEGANCE,SEACCENTA,VISIA1,5CDI		E	'E 'H	CTR5770

NAVARA

01/2005 →

Rod/Strut, stabiliser	2.5DCI 4.0 V6		E	'E	CTR6150L
Rod/Strut, stabiliser	2.5DCI 4.0 V6		E	'H	CTR6150R

NP200

01/2008 →

Ball Joint	1.5DCI SE, 1.6 S,SE		E	'E 'H	CJ1145
Track Control Arm	1.5DCI SE, 1.6 S,SE		E	'E	CJ320L
Track Control Arm	1.5DCI SE, 1.6 S,SE		E	'H	CJ320R
Tie Rod End	1.5DCI SE, 1.6 S,SE		E	'E	CTR5985L
Tie Rod End	1.5DCI SE, 1.6 S,SE		E	'H	CTR5985R
Tie Rod Axle Joint	1.5DCI SE, 1.6 S,SE		E	'E 'H	RE5986

						
BS8147	BS8218	CJ1145	CJ320L	CJ320R	CTR5726L	CTR5726R
Ref.Nr.: 54501BC41A	Ref.Nr.: 54570AX600	Ref.Nr.: 8200679067	Ref.Nr.: 6001547520	Ref.Nr.: 6001547519	Ref.Nr.: 7701476760	Ref.Nr.: 7701475843
						
CTR5770	CTR5985L	CTR5985R	CTR6150L	RE5986		
Ref.Nr.: 8200127308	Ref.Nr.: 6001550442	Ref.Nr.: 6001547611	Ref.Nr.: 54668EA010	Ref.Nr.: 6001550441		

Article Description			Fitting Position	Article No.
---------------------	---	---	------------------	-------------

PATHFINDER

01/2005 →

Rod/Strut, stabiliser	2.5DCI 4.0 V6		E	'E		CTR6150L
Rod/Strut, stabiliser	2.5DCI 4.0 V6		E		'H	CTR6150R

PRIMERA

01/1998 → 12/2002

Rod/Strut, stabiliser	160SI,SE,200GSI,SI,STI,ELEGANCE,LUXURY		E	'E	'H	CTR5559
Tie Rod Axle Joint	160SI,SE,200GSI,SI,STI,ELEGANCE,LUXURY		E	'E	'H	RE053

SABRE

01/1994 → 12/2002

Rod/Strut, stabiliser	160SI,SE,200GSI,SI,STI		E	'E	'H	CTR5559
Tie Rod Axle Joint	160SI,SE,200GSI,SI,STI		E	'E	'H	RE053

SENTRA

01/1992 → 12/2002

Rod/Strut, stabiliser	160SI,SE,200GSI,SI,STI	P/S	E	'E	'H	CTR5559
Tie Rod Axle Joint	160SI,SE,200GSI,SI,STI	P/S	E	'E	'H	RE053

TIIDA HATCHBACK

01/2007 → 12/2011

Track Control Arm	1.6 ACENTA,VISIA,1.8 ACENTA		E	'E		CJ299L
Track Control Arm	1.6 ACENTA,VISIA,1.8 ACENTA		E		'H	CJ299R
Tie Rod Axle Joint	1.6 ACENTA,VISIA,1.8 ACENTA		E	'E	'H	RE5990

TIIDA SALOON





01/2007 → 12/2012

Track Control Arm	1.6 ACENTA,VISIA,1.8 ACENTA		E	'E		CJ299L
Track Control Arm	1.6 ACENTA,VISIA,1.8 ACENTA		E		'H	CJ299R

TIIDA SALOON

01/2007 → 12/2012

Tie Rod Axle Joint	1.6 ACENTA,VISIA,1.8 ACENTA		E	'E	'H	RE5990
--------------------	-----------------------------	--	---	----	----	--------

					
CJ299L	CJ299R	CTR5559	CTR6150L	RE053	RE5990
Ref.Nr.: 8200744091	Ref.Nr.: 8200744092	Ref.Nr.: 54618D5000	Ref.Nr.: 54668EA010	Ref.Nr.: 4852150Y00	Ref.Nr.: 485213U025

Article Description			Fitting Position	Article No.
---------------------	---	---	------------------	-------------

X-TRAIL (T30)

07/2001 → 01/2013

Rod/Strut, stabiliser	2.0, 2.0 4x4, 2.2 dCi, 2.2 dCi 4x4, 2.2 Di 4x4, 2.5 4x4	E	E	CTR5675L
Rod/Strut, stabiliser	2.0, 2.0 4x4, 2.2 dCi, 2.2 dCi 4x4, 2.2 Di 4x4, 2.5 4x4	E	H	CTR5675R

	
<p>CTR5675L</p>	<p>CTR5675R</p>
<p>Ref.Nr.: 546688H300</p>	<p>Ref.Nr.: 546188H300</p>

Article Description			Fitting Position	Article No.
---------------------	---	---	------------------	-------------

ASCONA C (81_, 86_, 87_, 88_)

09/1981 → 08/1988

Ball Joint	1.3N, 1.3S, 1.6, 1.6D, 1.6i, 1.6i CAT, 1.6S, 1.8, 1.8E, 1.8 i, 2.0, 2.0i, 2.0i CAT, 2.0i GT	with add-on material	E	'E 'H	CJ951
------------	---	----------------------	---	-------	-------

ASCONA C Hatchback (84_, 89_)

09/1981 → 08/1988

Ball Joint	1.3N, 1.3S, 1.6, 1.6D, 1.6i, 1.6i CAT, 1.6S, 1.8, 1.8E, 1.8 i, 2.0i, 2.0i CAT, 2.0i GT	with add-on material	E	'E 'H	CJ951
------------	--	----------------------	---	-------	-------

ASTRA F (56_, 57_)

09/1991 → 09/1998

Control Arm-/Trailing Arm Bush	1.4i, 1.4i 16V, 1.4 Si, 1.6i, 1.6i 16V, 1.6 Si, 1.7 D, 1.7 TD, 1.7 TDS, 1.8 i, 1.8 i 16V, 2.0 i, 2.0 i 16V	ch.R2595226, R5111735, R6036588, R8145950, RB011798→	E	'E 'H	BS6383
Control Arm-/Trailing Arm Bush	1.4i, 1.4i 16V, 1.4 Si, 1.6i, 1.6i 16V, 1.6 Si, 1.7 D, 1.7 TD, 1.7 TDS, 1.8 i, 1.8 i 16V, 2.0 i, 2.0 i 16V	ch.→R2595225, R5111734, R6036587, R8145949, RB011797	E	'E 'H	BS6406
Track Control Arm	1.4 i, 1.4 Si, 1.6 i, 1.6 Si, 1.7 D	ch.→R2595225, R5111734, R8145949	E	'E	CJ1501L
Track Control Arm	1.4, 1.4 i 16V, 1.6, 1.6 i 16V, 1.8 i 16V		E	'E	CJ1501L
Track Control Arm	1.7 TD, 1.7 TDS, 1.8 i, 1.8 i 16V	ch.→R2588487, R5111734, R8145949	E	'E	CJ1501L
Track Control Arm	2.0 i	ch.→R2589925, R5111734, R8145949	E	'E	CJ1501L
Track Control Arm	2.0 i 16V	ch.→P2603822, P8146889	E	'E	CJ1501L
Track Control Arm	1.4 i, 1.4 Si, 1.6 i, 1.6 Si, 1.7 D	ch.→R2595225, R5111734, R8145949	E	'H	CJ1501R
Track Control Arm	1.4, 1.4 i 16V, 1.6, 1.6 i 16V, 1.8 i 16V		E	'H	CJ1501R
Track Control Arm	1.7 TD, 1.7 TDS, 1.8 i, 1.8 i 16V	ch.→R2588487, R5111734, R8145949	E	'H	CJ1501R
Track Control Arm	2.0 i	ch.→R2589925, R5111734, R8145949	E	'H	CJ1501R
Track Control Arm	2.0 i 16V	ch.→P2603822, P8146889	E	'H	CJ1501R
Ball Joint	1.4, 1.4i, 1.4i 16V, 1.4 Si, 1.6, 1.6i, 1.6i 16V, 1.6 Si, 1.7 D, 1.7 TD, 1.7 TDS, 1.8 i, 1.8 i 16V, 2.0 i, 2.0 i 16V	with add-on material	E	'E 'H	CJ951
Tie Rod End	1.4i, 1.4i 16V, 1.4 Si, 1.6i, 1.6i 16V, 1.6 Si, 1.7 D, 1.7 TD, 1.7 TDS, 1.8 i, 1.8 i 16V, 2.0 i, 2.0 i 16V	for OE: 324055	E	'E	CTR5427L
Tie Rod End	1.4i, 1.4i 16V, 1.4 Si, 1.6i, 1.6i 16V, 1.6 Si, 1.7 D, 1.7 TD, 1.7 TDS, 1.8 i, 1.8 i 16V, 2.0 i, 2.0 i 16V	for OE: 324056	E	'H	CTR5427R
Rod/Strut, stabiliser	1.4i, 1.4i 16V, 1.4 Si, 1.6i, 1.6i 16V, 1.6 Si, 1.7 D, 1.7 TD, 1.7 TDS, 1.8 i, 1.8 i 16V, 2.0 i, 2.0 i 16V	for OE: 350 263	E	'E 'H	CTR5643
Rod/Strut, stabiliser	1.4, 1.6	ch.R2595226, R5111735, R8145950, RB011798→; for OE: 350 263	E	'E 'H	CTR5643

ASTRA F Convertible (53_B)

03/1993 → 03/2001

Control Arm-/Trailing Arm Bush	1.4 i 16V, 1.4 Si, 1.6 i, 1.8 i 16V, 2.0 i	ch.R2595226, R5111735, R6036588, R8145950, RB011798→	E	'E 'H	BS6383
Control Arm-/Trailing Arm Bush	1.4 i 16V, 1.4 Si, 1.6 i, 1.8 i 16V, 2.0 i	ch.→R2595225, R5111734, R6036587, R8145949, RB011797	E	'E 'H	BS6406
Track Control Arm	1.4 i 16V, 1.6 i, 1.8 i 16V		E	'E	CJ1501L
Track Control Arm	1.4 Si, 1.6 i	ch.→R2595225, R5111734, R8145949	E	'E	CJ1501L
Track Control Arm	2.0 i	ch.→R2589925, R5111734, R8145949	E	'E	CJ1501L
Track Control Arm	1.4 i 16V, 1.6 i, 1.8 i 16V		E	'H	CJ1501R
Track Control Arm	1.4 Si, 1.6 i	ch.→R2595225, R5111734, R8145949	E	'H	CJ1501R
Track Control Arm	2.0 i	ch.→R2589925, R5111734, R8145949	E	'H	CJ1501R
Ball Joint	1.4 i 16V, 1.4 Si, 1.6 i, 1.8 i 16V, 2.0 i	with add-on material	E	'E 'H	CJ951
Tie Rod End	1.4 i 16V, 1.4 Si, 1.6 i, 1.8 i 16V, 2.0 i	for OE: 324055	E	'E	CTR5427L
Tie Rod End	1.4 i 16V, 1.4 Si, 1.6 i, 1.8 i 16V, 2.0 i	for OE: 324056	E	'H	CTR5427R
Rod/Strut, stabiliser	1.4 i 16V, 1.4 Si, 1.6 i, 1.8 i 16V, 2.0 i	for OE: 350 263	E	'E 'H	CTR5643

						
BS6383	BS6406	CJ1501L	CJ1501R	CJ951	CTR5427L	CTR5427R
Ref.Nr.: 90268463	Ref.Nr.: 90373778	Ref.Nr.: 0352077	Ref.Nr.: 0352192	Ref.Nr.: 1603163	Ref.Nr.: 90350447	Ref.Nr.: 0324054
						
CTR5643						
Ref.Nr.: 4400040						

Article Description			Fitting Position	Article No.
---------------------	---	---	------------------	-------------

ASTRA F Estate (51_, 52_)

09/1991 → 01/1998

Control Arm-/Trailing Arm Bush	1.4 i, 1.4 i 16V, 1.4 Si, 1.6 i, 1.6 i 16V, 1.6 Si, 1.7 D, 1.7 TD, 1.7 TDS, 1.8 i, 1.8 i 16V, 2.0 i, 2.0 i 16V	ch.R2595226, R5111735, R6036588, R8145950, RB011798→	E	'E 'H	BS6383
Control Arm-/Trailing Arm Bush	1.4 i, 1.4 i 16V, 1.4 Si, 1.6 i, 1.6 i 16V, 1.6 Si, 1.7 D, 1.7 TD, 1.7 TDS, 1.8 i, 1.8 i 16V, 2.0 i, 2.0 i 16V	ch.→R2595225, R5111734, R6036587, R8145949, RB011797	E	'E 'H	BS6406
Track Control Arm	1.4 i, 1.4 Si, 1.6 i, 1.6 Si	ch.→R2595225, R5111734, R8145949	E	'E	CJ1501L
Track Control Arm	1.4, 1.4 i 16V, 1.6, 1.6 i 16V, 1.8 i 16V		E	'E	CJ1501L
Track Control Arm	1.7 D, 1.7 TD, 1.7 TDS, 1.8 i, 1.8 i 16V	ch.→R2588487, R5111734, R8145949	E	'E	CJ1501L
Track Control Arm	2.0 i	ch.→R2589925, R5111734, R8145949	E	'E	CJ1501L
Track Control Arm	2.0 i 16V	ch.→P2603822, P8146889	E	'E	CJ1501L
Track Control Arm	1.4 i, 1.4 Si, 1.6 i, 1.6 Si	ch.→R2595225, R5111734, R8145949	E	'H	CJ1501R
Track Control Arm	1.4, 1.4 i 16V, 1.6, 1.6 i 16V, 1.8 i 16V		E	'H	CJ1501R
Track Control Arm	1.7 D, 1.7 TD, 1.7 TDS, 1.8 i, 1.8 i 16V	ch.→R2588487, R5111734, R8145949	E	'H	CJ1501R
Track Control Arm	2.0 i	ch.→R2589925, R5111734, R8145949	E	'H	CJ1501R
Track Control Arm	2.0 i 16V	ch.→P2603822, P8146889	E	'H	CJ1501R
Ball Joint	1.4, 1.4 i, 1.4 i 16V, 1.4 Si, 1.6, 1.6 i, 1.6 i 16V, 1.6 Si, 1.7 D, 1.7 TD, 1.7 TDS, 1.8 i, 1.8 i 16V, 2.0 i, 2.0 i 16V	with add-on material	E	'E 'H	CJ951
Tie Rod End	1.4 i, 1.4 i 16V, 1.4 Si, 1.6 i, 1.6 i 16V, 1.6 Si, 1.7 D, 1.7 TD, 1.7 TDS, 1.8 i, 1.8 i 16V, 2.0 i, 2.0 i 16V	for OE: 324055	E	'E	CTR5427L
Tie Rod End	1.4 i, 1.4 i 16V, 1.4 Si, 1.6 i, 1.6 i 16V, 1.6 Si, 1.7 D, 1.7 TD, 1.7 TDS, 1.8 i, 1.8 i 16V, 2.0 i, 2.0 i 16V	for OE: 324056	E	'H	CTR5427R
Rod/Strut, stabiliser	1.4	ch.R2595226, R5111735, R8145950, RB011798→; for OE: 350 263	E	'E 'H	CTR5643
Rod/Strut, stabiliser	1.4 i, 1.4 i 16V, 1.4 Si, 1.6, 1.6 i, 1.6 i 16V, 1.6 Si, 1.7 D, 1.7 TD, 1.7 TDS, 1.8 i, 1.8 i 16V, 2.0 i, 2.0 i 16V	for OE: 350 263	E	'E 'H	CTR5643

ASTRA F Hatchback (53_, 54_, 58_, 59_)

09/1991 → 01/1998

Control Arm-/Trailing Arm Bush	1.4 i, 1.4 i 16V, 1.4 Si, 1.6 i, 1.6 i 16V, 1.6 Si, 1.7 D, 1.7 TD, 1.7 TDS, 1.8 i, 1.8 i 16V, 2.0 GSI 16V, 2.0 i, 2.0 i 16V	ch.R2595226, R5111735, R6036588, R8145950, RB011798→	E	'E 'H	BS6383
Control Arm-/Trailing Arm Bush	1.4 i, 1.4 i 16V, 1.4 Si, 1.6 i, 1.6 i 16V, 1.6 Si, 1.7 D, 1.7 TD, 1.7 TDS, 1.8 i, 1.8 i 16V, 2.0 GSI 16V, 2.0 i, 2.0 i 16V	ch.→R2595225, R5111734, R6036587, R8145949, RB011797	E	'E 'H	BS6406
Track Control Arm	1.4 i, 1.4 Si, 1.6 i, 1.6 Si	ch.→R2595225, R5111734, R8145949	E	'E	CJ1501L
Track Control Arm	1.4, 1.4 i 16V, 1.6, 1.6 i 16V, 1.8 i 16V		E	'E	CJ1501L
Track Control Arm	1.7 D	ch.→R2591895, R5111734, R8145949	E	'E	CJ1501L
Track Control Arm	1.7 TD, 1.7 TDS, 1.8 i, 1.8 i 16V	ch.→R2588487, R5111734, R8145949	E	'E	CJ1501L
Track Control Arm	2.0 GSI 16V, 2.0 i 16V	ch.→P2603822, P8146889	E	'E	CJ1501L
Track Control Arm	2.0 i	ch.→R2589925, R5111734, R8145949	E	'E	CJ1501L
Track Control Arm	1.4 i, 1.4 Si, 1.6 i, 1.6 Si	ch.→R2595225, R5111734, R8145949	E	'H	CJ1501R
Track Control Arm	1.4, 1.4 i 16V, 1.6, 1.6 i 16V, 1.8 i 16V		E	'H	CJ1501R
Track Control Arm	1.7 D	ch.→R2591895, R5111734, R8145949	E	'H	CJ1501R
Track Control Arm	1.7 TD, 1.7 TDS, 1.8 i, 1.8 i 16V	ch.→R2588487, R5111734, R8145949	E	'H	CJ1501R
Track Control Arm	2.0 GSI 16V, 2.0 i 16V	ch.→P2603822, P8146889	E	'H	CJ1501R
Track Control Arm	2.0 i	ch.→R2589925, R5111734, R8145949	E	'H	CJ1501R
Ball Joint	1.4, 1.4 i, 1.4 i 16V, 1.4 Si, 1.6, 1.6 i, 1.6 i 16V, 1.6 Si, 1.7 D, 1.7 TD, 1.7 TDS, 1.8 i, 1.8 i 16V, 2.0 GSI 16V, 2.0 i, 2.0 i 16V	with add-on material	E	'E 'H	CJ951
Tie Rod End	1.4 i, 1.4 i 16V, 1.4 Si, 1.6 i, 1.6 i 16V, 1.6 Si, 1.7 D, 1.7 TD, 1.7 TDS, 1.8 i, 1.8 i 16V, 2.0 GSI 16V, 2.0 i, 2.0 i 16V	for OE: 324055	E	'E	CTR5427L
Tie Rod End	1.4 i, 1.4 i 16V, 1.4 Si, 1.6 i, 1.6 i 16V, 1.6 Si, 1.7 D, 1.7 TD, 1.7 TDS, 1.8 i, 1.8 i 16V, 2.0 GSI 16V, 2.0 i, 2.0 i 16V	for OE: 324056	E	'H	CTR5427R

						
BS6383	BS6406	CJ1501L	CJ1501R	CJ951	CTR5427L	CTR5427R
Ref.Nr.: 90268463	Ref.Nr.: 90373778	Ref.Nr.: 0352077	Ref.Nr.: 0352192	Ref.Nr.: 1603163	Ref.Nr.: 90350447	Ref.Nr.: 0324054
						
CTR5643						
Ref.Nr.: 4400040						

Article Description			Fitting Position	Article No.
---------------------	---	---	------------------	-------------

ASTRA F Hatchback (53_, 54_, 58_, 59_) 09/1991 → 01/1998

Rod/Strut, stabiliser	1.4 i, 1.4 i 16V, 1.4 Si, 1.6 i, 1.6 i 16V, 1.6 Si, 1.7 D, 1.7 TD, 1.7 TDS, 1.8 i, 1.8 i 16V, 2.0 GSI 16V, 2.0 i, 2.0 i 16V	for OE: 350 263	E	'E 'H	CTR5643
Rod/Strut, stabiliser	1.4, 1.6	ch.R2595226, R5111735, R8145950, RB011798→; for OE: 350 263	E	'E 'H	CTR5643

ASTRA F CLASSIC Estate 01/1998 → 01/2005

Control Arm-/Trailing Arm Bush	1.4 i, 1.6 i, 1.6 i 16V		E	'E 'H	BS6383
Control Arm-/Trailing Arm Bush	1.4 i, 1.6 i, 1.6 i 16V		E	'E 'H	BS6406
Track Control Arm	1.4 i, 1.6 i, 1.6 i 16V		E	'E	CJ1501L
Track Control Arm	1.4 i, 1.6 i, 1.6 i 16V		E	'H	CJ1501R
Ball Joint	1.4 Comfort, 1.4 i, 1.6 i, 1.6 i 16V, 1.8	with add-on material	E	'E 'H	CJ951
Rod/Strut, stabiliser	1.4 Comfort, 1.4 i, 1.6 i, 1.6 i 16V, 1.8	for OE: 350 263	E	'E 'H	CTR5643

ASTRA F CLASSIC Hatchback 01/1998 → 08/2002

Control Arm-/Trailing Arm Bush	1.4 i, 1.6 i, 1.6 i 16V		E	'E 'H	BS6383
Control Arm-/Trailing Arm Bush	1.4 i, 1.6 i, 1.6 i 16V		E	'E 'H	BS6406
Track Control Arm	1.4 i, 1.6 i, 1.6 i 16V		E	'E	CJ1501L
Track Control Arm	1.4 i, 1.6 i, 1.6 i 16V		E	'H	CJ1501R
Ball Joint	1.2 i, 1.4 i, 1.6 i, 1.6 i 16V, 1.7 TD, 1.8 i, 2.0 Di, 2.0 DTi, 2.0 i	with add-on material	E	'E 'H	CJ951
Rod/Strut, stabiliser	1.2 i, 1.4 i, 1.6 i, 1.6 i 16V, 1.7 TD, 1.8 i, 2.0 Di, 2.0 DTi, 2.0 i	for OE: 350 263	E	'E 'H	CTR5643

ASTRA F CLASSIC Saloon 01/1998 → 08/2002

Control Arm-/Trailing Arm Bush	1.4 i, 1.6 i, 1.6 i 16V		E	'E 'H	BS6383
Control Arm-/Trailing Arm Bush	1.4 i, 1.6 i, 1.6 i 16V		E	'E 'H	BS6406
Track Control Arm	1.4 i, 1.6 i, 1.6 i 16V		E	'E	CJ1501L
Track Control Arm	1.4 i, 1.6 i, 1.6 i 16V		E	'H	CJ1501R
Ball Joint	1.4 i, 1.6 i, 1.6 i 16V	with add-on material	E	'E 'H	CJ951
Rod/Strut, stabiliser	1.4 i, 1.6 i, 1.6 i 16V	for OE: 350 263	E	'E 'H	CTR5643

ASTRA F Van (55_) 10/1991 → 01/1999

Control Arm-/Trailing Arm Bush	1.4 i, 1.6 i, 1.7 D, 1.7 TD	ch.R2595226, R5111735, R6036588, R8145950, RB011798→	E	'E 'H	BS6383
Control Arm-/Trailing Arm Bush	1.4 i, 1.6 i, 1.7 D, 1.7 TD	ch.→R2595225, R5111734, R6036587, R8145949, RB011797	E	'E 'H	BS6406
Track Control Arm	1.4 i, 1.6 i, 1.7 D, 1.7 TD		E	'E	CJ1501L
Track Control Arm	1.4 i, 1.6 i, 1.7 D, 1.7 TD		E	'H	CJ1501R
Ball Joint	1.4 i, 1.6 i, 1.7 D, 1.7 TD	with add-on material	E	'E 'H	CJ951
Tie Rod End	1.4 i, 1.6 i, 1.7 D, 1.7 TD	for OE: 324055	E	'E	CTR5427L
Tie Rod End	1.4 i, 1.6 i, 1.7 D, 1.7 TD	for OE: 324056	E	'H	CTR5427R
Rod/Strut, stabiliser	1.4 i, 1.6 i, 1.7 D, 1.7 TD	for OE: 350 263	E	'E 'H	CTR5643

ASTRA G Convertible (F67) 03/2001 → 10/2005

Ball Joint	1.6, 1.6 16V, 1.8 16V, 2.0 16V Turbo, 2.0 OPC, 2.2 16V, 2.2 DTI	with add-on material	E	'E 'H	CJ1089
Rod/Strut, stabiliser	1.6, 1.6 16V, 1.8 16V, 2.0 16V Turbo, 2.0 OPC, 2.2 16V, 2.2 DTI	Alternative Repair Kit: G7-1517; Material: Plastic	E	'E 'H	CTR2462

						
BS6383	BS6406	CJ1089	CJ1501L	CJ1501R	CJ951	CTR2462
Ref.Nr.: 90268463	Ref.Nr.: 90373778	Ref.Nr.: 90542995	Ref.Nr.: 0352077	Ref.Nr.: 0352192	Ref.Nr.: 1603163	Ref.Nr.: 350614
						
CTR5427L	CTR5427R	CTR5643				
Ref.Nr.: 90350447	Ref.Nr.: 0324054	Ref.Nr.: 4400040				

Article Description			Fitting Position	Article No.
---------------------	---	---	------------------	-------------

ASTRA G Convertible (F67)

03/2001 → 10/2005

Tie Rod End	1.6, 1.6 16V, 1.8 16V, 2.0 16V Turbo, 2.0 OPC, 2.2 16V, 2.2 DTI		E	'E	'H	CTR5170
Top Strut Mounting	1.6, 1.6 16V, 1.8 16V, 2.0 16V Turbo, 2.0 OPC, 2.2 16V, 2.2 DTI	Soft Version; without ball bearing	E	'E	'H	MO6848

ASTRA G Estate (F35_)

02/1998 → 12/2009

Ball Joint	1.2 16V, 1.4, 1.4 16V, 1.6, 1.6 16V, 1.6 CNG, 1.7 CDTI, 1.7 DTI 16V, 1.7 TD, 1.8 16V, 2.0 16V, 2.0 DI, 2.0 DTI 16V, 2.0 OPC, 2.2 16V, 2.2 DTI	with add-on material	E	'E	'H	CJ1089
Rod/Strut, stabiliser	1.2 16V, 1.4, 1.4 16V, 1.6, 1.6 16V, 1.6 CNG, 1.7 CDTI, 1.7 DTI 16V, 1.7 TD, 1.8 16V, 2.0 16V, 2.0 DI, 2.0 DTI 16V, 2.0 OPC, 2.2 16V, 2.2 DTI	Alternative Repair Kit: G7-1517; Material: Plastic	E	'E	'H	CTR2462
Tie Rod End	1.2 16V, 1.4, 1.4 16V, 1.6, 1.6 16V, 1.6 CNG, 1.7 CDTI, 1.7 DTI 16V, 1.7 TD, 1.8 16V, 2.0 16V, 2.0 DI, 2.0 DTI 16V, 2.0 OPC, 2.2 16V, 2.2 DTI		E	'E	'H	CTR5170
Top Strut Mounting	1.2 16V, 1.4 16V, 1.6, 1.6 16V, 1.6 CNG, 1.7 CDTI, 1.7 DTI 16V, 1.7 TD, 1.8 16V, 2.0 16V, 2.0 DI, 2.0 DTI 16V, 2.0 OPC, 2.2 16V, 2.2 DTI	Soft Version; without ball bearing	E	'E	'H	MO6848
Tie Rod Axle Joint	1.2 16V, 1.4 16V, 1.6, 1.6 16V, 1.7 DTI 16V, 1.7 TD, 1.8 16V, 2.0 16V, 2.0 DI, 2.0 DTI 16V	for OE: 1603213	E	'E	'H	RE5547

ASTRA G Hatchback (F48_, F08_)

02/1998 → 12/2009

Ball Joint	1.0, 1.2 16V, 1.4, 1.4 16V, 1.6, 1.6 16V, 1.7 CDTI, 1.7 DTI 16V, 1.7 TD, 1.8, 1.8 16V, 2.0 16V, 2.0 16V OPC, 2.0 DI, 2.0 DTI 16V, 2.0 OPC, 2.2 16V, 2.2 DTI	with add-on material	E	'E	'H	CJ1089
Rod/Strut, stabiliser	1.0, 1.2 16V, 1.4, 1.4 16V, 1.6, 1.6 16V, 1.7 CDTI, 1.7 DTI 16V, 1.7 TD, 1.8, 1.8 16V, 2.0 16V, 2.0 16V OPC, 2.0 DI, 2.0 DTI 16V, 2.0 OPC, 2.2 16V, 2.2 DTI	Alternative Repair Kit: G7-1517; Material: Plastic	E	'E	'H	CTR2462
Tie Rod End	1.0, 1.2 16V, 1.4, 1.4 16V, 1.6, 1.6 16V, 1.7 CDTI, 1.7 DTI 16V, 1.7 TD, 1.8, 1.8 16V, 2.0 16V, 2.0 16V OPC, 2.0 DI, 2.0 DTI 16V, 2.0 OPC, 2.2 16V, 2.2 DTI		E	'E	'H	CTR5170
Top Strut Mounting	1.2 16V, 1.4 16V, 1.6, 1.6 16V, 1.7 CDTI, 1.7 DTI 16V, 1.7 TD, 1.8 16V, 2.0 16V, 2.0 16V OPC, 2.0 DI, 2.0 DTI 16V, 2.0 OPC, 2.2 16V, 2.2 DTI	Soft Version; without ball bearing	E	'E	'H	MO6848
Tie Rod Axle Joint	1.2 16V, 1.4 16V, 1.6, 1.6 16V, 1.7 DTI 16V, 1.7 TD, 1.8 16V, 2.0 16V, 2.0 16V OPC, 2.0 DI, 2.0 DTI 16V	for OE: 1603213	E	'E	'H	RE5547

ASTRA G Coupe (F07_)

03/2000 → 05/2005

Ball Joint	1.6 16V, 1.8 16V, 2.0 16V Turbo, 2.2 16V, 2.2 DTI	with add-on material	E	'E	'H	CJ1089
Rod/Strut, stabiliser	1.6 16V, 1.8 16V, 2.0 16V Turbo, 2.2 16V, 2.2 DTI	Alternative Repair Kit: G7-1517; Material: Plastic	E	'E	'H	CTR2462
Tie Rod End	1.6 16V, 1.8 16V, 2.0 16V Turbo, 2.2 16V, 2.2 DTI		E	'E	'H	CTR5170
Top Strut Mounting	1.6 16V, 1.8 16V, 2.0 16V Turbo, 2.2 16V, 2.2 DTI	Soft Version; without ball bearing	E	'E	'H	MO6848
Tie Rod Axle Joint	1.8 16V, 2.0 16V Turbo, 2.2 16V	for OE: 1603213	E	'E	'H	RE5547

ASTRA G Box (F70)

01/1999 → 04/2005

Ball Joint	1.6, 1.7 TD, 2.0 DI	with add-on material	E	'E	'H	CJ1089
Rod/Strut, stabiliser	1.6, 1.7 TD, 2.0 DI	Alternative Repair Kit: G7-1517; Material: Plastic	E	'E	'H	CTR2462
Tie Rod End	1.6, 1.7 TD, 2.0 DI		E	'E	'H	CTR5170
Top Strut Mounting	1.6, 1.7 TD, 2.0 DI	Soft Version; without ball bearing	E	'E	'H	MO6848
Tie Rod Axle Joint	1.6, 1.7 TD, 2.0 DI	for OE: 1603213	E	'E	'H	RE5547

				
CJ1089	CTR2462	CTR5170	MO6848	RE5547
Ref.Nr.: 90542995	Ref.Nr.: 350614	Ref.Nr.: 26059294	Ref.Nr.: 344523	Ref.Nr.: 1603213

Article Description			Fitting Position	Article No.
---------------------	---	---	------------------	-------------

ASTRA G Saloon (F69_)

09/1998 → 12/2009

Ball Joint	1.216V, 1.4, 1.4 16V, 1.6, 1.6 16V, 1.7 CDTI, 1.7 DTI 16V, 1.7 TD, 1.8 16V, 2.0 16V, 2.0 DI, 2.0 DTI 16V, 2.2 16V, 2.2	with add-on material	E	E	H	CJ1089
Rod/Strut, stabiliser	1.216V, 1.4, 1.4 16V, 1.6, 1.6 16V, 1.7 CDTI, 1.7 DTI 16V, 1.7 TD, 1.8 16V, 2.0 16V, 2.0 DI, 2.0 DTI 16V, 2.2 16V, 2.2	Alternative Repair Kit: G7-1517; Material: Plastic	E	E	H	CTR2462
Tie Rod End	1.216V, 1.4, 1.4 16V, 1.6, 1.6 16V, 1.7 CDTI, 1.7 DTI 16V, 1.7 TD, 1.8 16V, 2.0 16V, 2.0 DI, 2.0 DTI 16V, 2.2 16V, 2.2		E	E	H	CTR5170
Top Strut Mounting	1.216V, 1.4 16V, 1.6, 1.6 16V, 1.7 CDTI, 1.7 DTI 16V, 1.7 TD, 1.8 16V, 2.0 16V, 2.0 DI, 2.0 DTI 16V, 2.2 16V, 2.2 DTI	Soft Version; without ball bearing	E	E	H	MO6848
Tie Rod Axle Joint	1.2 16V, 1.4 16V, 1.6, 1.6 16V, 1.7 DTI 16V, 1.7 TD, 1.8 16V, 2.0 16V, 2.0 DI, 2.0 DTI 16V	for OE: 1603213	E	E	H	RE5547

ASTRA H (L48)

03/2004 → 10/2004

Ball Joint	1.2, 1.3 CDTI, 1.4, 1.4 LPG, 1.6, 1.6 Turbo, 1.7 CDTI, 1.8, 1.9 CDTI, 1.9 CDTI 16V, 2.0 Turbo	with add-on material	E	E	H	CJ1089
Rod/Strut, stabiliser	1.2, 1.3 CDTI, 1.4, 1.4 LPG, 1.6, 1.6 Turbo, 1.7 CDTI, 1.8, 1.9 CDTI, 1.9 CDTI 16V, 2.0 Turbo	Alternative Repair Kit: G7-1517; Material: Plastic; for vehicles without IDS suspension	E	E	H	CTR2462

ASTRA H Estate (L35)

08/2004 →

Ball Joint	1.3 CDTI, 1.4, 1.4 LPG, 1.6, 1.6 LPG, 1.6 Turbo, 1.7 CDTI, 1.8, 1.9 CDTI, 1.9 CDTI 16V, 2.0 Turbo	with add-on material	E	E	H	CJ1089
Rod/Strut, stabiliser	1.3 CDTI, 1.4, 1.4 LPG, 1.6, 1.6 LPG, 1.6 Turbo, 1.7 CDTI, 1.8, 1.9 CDTI, 1.9 CDTI 16V, 2.0 Turbo	Alternative Repair Kit: G7-1517; Material: Plastic; for vehicles without IDS suspension	E	E	H	CTR2462

ASTRA H Sport Hatch (L08)

03/2005 →

Ball Joint	1.2, 1.3 CDTI, 1.4, 1.6, 1.6 Turbo, 1.7 CDTI, 1.8, 1.9 CDTI, 1.9 CDTI 16V, 2.0 Turbo	with add-on material	E	E	H	CJ1089
Rod/Strut, stabiliser	1.2, 1.3 CDTI, 1.4, 1.6, 1.6 Turbo, 1.7 CDTI, 1.8, 1.9 CDTI, 1.9 CDTI 16V, 2.0 Turbo	Alternative Repair Kit: G7-1517; Material: Plastic; for vehicles without IDS suspension	E	E	H	CTR2462

ASTRA H Saloon (L69)

02/2007 →

Ball Joint	1.3 CDTi, 1.6, 1.7 CDTi, 1.8	with add-on material	E	E	H	CJ1089
Rod/Strut, stabiliser	1.3 CDTi, 1.6, 1.7 CDTi, 1.8	Alternative Repair Kit: G7-1517; Material: Plastic; for vehicles without IDS suspension	E	E	H	CTR2462

CALIBRA A (85_)

06/1990 → 07/1997

Control Arm-/Trailing Arm Bush	2.0 i 16V, 2.0 i 16V 4x4		E	E	H	BS6383
Control Arm-/Trailing Arm Bush	2.0 i, 2.0 i 4x4, 2.0 i Turbo 4x4, 2.5 i V6	ch.R9003127→	E	E	H	BS6383
Control Arm-/Trailing Arm Bush	2.0 i 16V, 2.0 i 16V 4x4		E	E	H	BS6406
Control Arm-/Trailing Arm Bush	2.0 i, 2.0 i 4x4, 2.0 i Turbo 4x4, 2.5 i V6	ch.→R9003126	E	E	H	BS6406
Track Control Arm	2.0 i 16V, 2.0 i 16V 4x4, 2.0 i Turbo 4x4, 2.5 i V6		E	E		CJ1501L
Track Control Arm	2.0 i, 2.0 i 4x4	ch.→R9003126	E	E		CJ1501L
Track Control Arm	2.0 i 16V, 2.0 i 16V 4x4, 2.0 i Turbo 4x4, 2.5 i V6		E		H	CJ1501R
Track Control Arm	2.0 i, 2.0 i 4x4	ch.→R9003126	E		H	CJ1501R
Ball Joint	2.0 i, 2.0 i 16V, 2.0 i 16V 4x4, 2.0 i 4x4, 2.0 i Turbo 4x4	ch.→S1999999, S9999999; with add-on material	E	E	H	CJ951
Tie Rod End	2.0 i, 2.0 i 16V, 2.0 i 16V 4x4, 2.0 i 4x4, 2.0 i Turbo 4x4, 2.5 i V	for OE: 324055	E	E		CTR5427L
Tie Rod End	2.0 i, 2.0 i 16V, 2.0 i 16V 4x4, 2.0 i 4x4, 2.0 i Turbo 4x4, 2.5 i V	for OE: 324056	E		H	CTR5427R
Rod/Strut, stabiliser	2.0 i, 2.0 i 16V, 2.0 i 16V 4x4, 2.0 i 4x4, 2.0 i Turbo 4x4, 2.5 i V	for OE: 350 263	E	E	H	CTR5643

						
BS6383	BS6406	CJ1089	CJ1501L	CJ1501R	CJ951	CTR2462
Ref.Nr.: 90268463	Ref.Nr.: 90373778	Ref.Nr.: 90542995	Ref.Nr.: 0352077	Ref.Nr.: 0352192	Ref.Nr.: 1603163	Ref.Nr.: 350614
						
CTR5170	CTR5427L	CTR5427R	CTR5643	MO6848	RE5547	
Ref.Nr.: 26059294	Ref.Nr.: 90350447	Ref.Nr.: 0324054	Ref.Nr.: 4400040	Ref.Nr.: 344523	Ref.Nr.: 1603213	

Article Description			Fitting Position	Article No.
---------------------	---	---	------------------	-------------

COMBO B

07/1994 → 10/2001

Ball Joint	1.2, 1.4, 1.4 16V, 1.7 D	ch.V3023598, V4166926, V6066280→	E	'E	'H	CJ869
Tie Rod End	1.2, 1.4, 1.7 D		E	'E	'H	CTR5500
Tie Rod End	1.2, 1.4, 1.4 16V, 1.7 D	ch.→V3023597, V4166925, V6066279	E	'E	'H	CTR5506
Tie Rod Axle Joint	1.2, 1.4, 1.7 D	for OE: 322158; for vehicles with power steering	E	'E	'H	RE5815

COMBO C

10/2001 →

Suspension Kit	1.3CDTI16V, 1.4 16V, 1.6, 1.6CNG 16V, 1.7CDTI16V, 1.7 DI 16V, 1.7 DTI16V	with fastening material; for vehicles without off-road suspension	E	'E	'H	BS6102
Control Arm-/Trailing Arm Bush	1.3CDTI16V, 1.4 16V, 1.6, 1.6CNG 16V, 1.7CDTI16V, 1.7 DI 16V, 1.7 DTI16V		E	'E	'H	BS6103
Ball Joint	1.3CDTI16V, 1.4 16V, 1.6, 1.6CNG 16V, 1.7CDTI16V, 1.7 DI 16V, 1.7 DTI16V	Number of mounting bores: 3; with fastening material	E	'E	'H	CJ654
Tie Rod End	1.3CDTI16V, 1.4 16V, 1.6, 1.6CNG 16V, 1.7CDTI16V, 1.7 DI 16V, 1.7 DTI16V		E	'E	'H	CTR5506
Rod/Strut, stabiliser	1.3CDTI16V, 1.4 16V, 1.6, 1.6CNG 16V, 1.7CDTI16V, 1.7 DI 16V, 1.7 DTI16V	Material: Metal	E	'E	'H	CTR5771
Tie Rod Axle Joint	1.3CDTI16V, 1.4 16V, 1.6, 1.6CNG 16V, 1.7CDTI16V, 1.7 DI 16V, 1.7 DTI16V	for vehicles with power steering	E	'E	'H	RE056
Tie Rod Axle Joint	1.3CDTI16V, 1.4 16V, 1.6, 1.6CNG 16V, 1.7CDTI16V, 1.7 DI 16V, 1.7 DTI16V	ch.→33999999, 34999999, 36999999	E	'E	'H	RE5499

CORSA B











01/1996 → 12/2002

Ball Joint	130I,160I LITE,CHILL,SEDAN	Lotus Suspension 1998-1999	E	'E	'H	CJ869
Tie Rod End	130I,160I LITE,CHILL,SEDAN	(Long) Lotus Suspension 1998-1999	E	'E	'H	CTR5500
Tie Rod End	130I,160I LITE,CHILL,SEDAN	(Short) Pre Lotus Suspension 1996-1998	E	'E	'H	CTR5506
Rod/Strut, stabiliser	130I,160I LITE,CHILL,SEDAN		E	'E	'H	CTR5771
Tie Rod Axle Joint	130I,160I LITE,CHILL,SEDAN	285 mm P/S	E	'E	'H	RE056
Rack End	130I,160I LITE,CHILL,SEDAN	310 mm M/S	E	'E	'H	RE1609
Tie Rod Axle Joint	130I,160I LITE,CHILL,SEDAN	305 mm M/S	E	'E	'H	RE5499
Tie Rod Axle Joint	130I,160I LITE,CHILL,SEDAN	280 mm M/S	E	'E	'H	RE5815

CORSA B PICKUP

01/1996 → 12/2002

Ball Joint	130I,160I LITE,CHILL,SEDAN	Lotus Suspension 1998-1999	E	'E	'H	CJ869
Tie Rod End	130I,160I LITE,CHILL,SEDAN	(Long) Lotus Suspension 1998-1999	E	'E	'H	CTR5500
Tie Rod End	130I,160I LITE,CHILL,SEDAN	(Short) Pre Lotus Suspension 1996-1998	E	'E	'H	CTR5506
Rod/Strut, stabiliser	130I,160I LITE,CHILL,SEDAN		E	'E	'H	CTR5771
Tie Rod Axle Joint	130I,160I LITE,CHILL,SEDAN	285 mm P/S	E	'E	'H	RE056
Rack End	130I,160I LITE,CHILL,SEDAN	310 mm M/S	E	'E	'H	RE1609
Tie Rod Axle Joint	130I,160I LITE,CHILL,SEDAN	305 mm M/S	E	'E	'H	RE5499
Tie Rod Axle Joint	130I,160I LITE,CHILL,SEDAN	280 mm M/S	E	'E	'H	RE5815

						
BS6102	BS6103	CJ654	CJ869	CTR5500	CTR5506	CTR5771
Ref.Nr.: 352309	Ref.Nr.: 24430103	Ref.Nr.: 9196394	Ref.Nr.: 1603302	Ref.Nr.: 324066	Ref.Nr.: 26087868	Ref.Nr.: 90496116
						
RE056	RE1609	RE5499	RE5815			
Ref.Nr.: 1603843	Ref.Nr.:	Ref.Nr.: 26087867	Ref.Nr.: 322158			

Article Description			Fitting Position	Article No.
---------------------	---	---	------------------	-------------

CORSA C

01/2000 → 12/2002

Suspension Kit	140I,160I,CLASIC,ACTIVE,GSI		E	E	H	BS6102
Control Arm-/Trailing Arm Bush	140I,160I,CLASIC,ACTIVE,GSI		E	E	H	BS6103
Ball Joint	140I,160I,CLASIC,ACTIVE,GSI		E	E	H	CJ869
Tie Rod End	140I,160I,CLASIC,ACTIVE,GSI	Long	E	E	H	CTR5500
Tie Rod End	140I,160I,CLASIC,ACTIVE,GSI	Short	E	E	H	CTR5506
Rod/Strut, stabiliser	140I,160I,CLASIC,ACTIVE,GSI		E	E	H	CTR5771
Top Strut Mounting	140I,160I,CLASIC,ACTIVE,GSI	Shock Mounting Front	E	E	H	MO6848
Tie Rod Axle Joint	140I,160I,CLASIC,ACTIVE,GSI	285 mm P/S	E	E	H	RE056
Rack End	140I,160I,CLASIC,ACTIVE,GSI	310 mm M/S	E	E	H	RE1609
Tie Rod Axle Joint	140I,160I,CLASIC,ACTIVE,GSI	305 mm M/S	E	E	H	RE5499
Tie Rod Axle Joint	140I,160I,CLASIC,ACTIVE,GSI	280 mm M/S	E	E	H	RE5815

CORSA C













01/2002 → 12/2008

Suspension Kit	140I,160I,1.7DTI,1.8I CLASSIC,ACTIVE,GSI,ELEGANCE,		E	E	H	BS6102
Control Arm-/Trailing Arm Bush	140I,160I,1.7DTI,1.8I CLASSIC,ACTIVE,GSI,ELEGANCE,		E	E	H	BS6103
Ball Joint	140I,160I,1.7DTI,1.8I CLASSIC,ACTIVE,GSI,ELEGANCE,		E	E	H	CJ654
Tie Rod End	140I,160I,1.7DTI,1.8I CLASSIC,ACTIVE,GSI,ELEGANCE,	Long	E	E	H	CTR5500
Rod/Strut, stabiliser	140I,160I,1.7DTI,1.8I CLASSIC,ACTIVE,GSI,ELEGANCE,		E	E	H	CTR5771
Top Strut Mounting	140I,160I,1.7DTI,1.8I CLASSIC,ACTIVE,GSI,ELEGANCE,	Shock Mounting Front	E	E	H	MO6848
Tie Rod Axle Joint	140I,160I,1.7DTI,1.8I CLASSIC,ACTIVE,GSI,ELEGANCE,	285 mm P/S	E	E	H	RE056
Rack End	140I,160I,1.7DTI,1.8I CLASSIC,ACTIVE,GSI,ELEGANCE,	310 mm M/S	E	E	H	RE1609
Tie Rod Axle Joint	140I,160I,1.7DTI,1.8I CLASSIC,ACTIVE,GSI,ELEGANCE,	305 mm M/S	E	E	H	RE5499
Tie Rod Axle Joint	140I,160I,1.7DTI,1.8I CLASSIC,ACTIVE,GSI,ELEGANCE,	280 mm M/S	E	E	H	RE5815

CORSA C UTILITY

01/2002 →

Suspension Kit	1.4I,1.7DTI,1.8I		E	E	H	BS6102
Control Arm-/Trailing Arm Bush	1.4I,1.7DTI,1.8I		E	E	H	BS6103
Ball Joint	1.4I,1.7DTI,1.8I		E	E	H	CJ654
Tie Rod End	1.4I,1.7DTI,1.8I	Long	E	E	H	CTR5500
Rod/Strut, stabiliser	1.4I,1.7DTI,1.8I		E	E	H	CTR5771
Top Strut Mounting	1.4I,1.7DTI,1.8I	Shock Mounting Front	E	E	H	MO6848
Tie Rod Axle Joint	1.4I,1.7DTI,1.8I	285 mm P/S	E	E	H	RE056
Rack End	1.4I,1.7DTI,1.8I	310 mm M/S	E	E	H	RE1609
Tie Rod Axle Joint	1.4I,1.7DTI,1.8I	305 mm M/S	E	E	H	RE5499
Tie Rod Axle Joint	1.4I,1.7DTI,1.8I	280 mm M/S	E	E	H	RE5815

						
BS6102	BS6103	CJ654	CJ869	CTR5500	CTR5506	CTR5771
Ref.Nr.: 352309	Ref.Nr.: 24430103	Ref.Nr.: 9196394	Ref.Nr.: 1603302	Ref.Nr.: 324066	Ref.Nr.: 26087868	Ref.Nr.: 90496116
						
MO6848	RE056	RE1609	RE5499	RE5815		
Ref.Nr.: 344523	Ref.Nr.: 1603843	Ref.Nr.:	Ref.Nr.: 26087867	Ref.Nr.: 322158		

Article Description			Fitting Position	Article No.
---------------------	---	---	------------------	-------------

KADET

01/1993 → 12/1999

Track Control Arm	140,160I,180I,200I,S,TS		E	'E		CJ1501L
Track Control Arm	140,160I,180I,200I,S,TS		E		'H	CJ1501R
Ball Joint	140,160I,180I,200I,S,TS		E	'E	'H	CJ951
Tie Rod End	140,160I,180I,200I,S,TS		E	'E		CTR5427L
Tie Rod End	140,160I,180I,200I,S,TS		E		'H	CTR5427R
Rod/Strut, stabiliser	140,160I,180I,200I,S,TS		E	'E	'H	CTR5643

MERIVA A

05/2003 → 05/2010

Suspension Kit	1.3CDTI, 1.4 16V Twinport, 1.4 16V Twinport LPG, 1.6, 1.6 16V, 1.7 CDTI, 1.7 DTI, 1.8	with fastening material	E	'E	'H	BS6102
Control Arm-Trailing Arm Bush	1.3CDTI, 1.4 16V Twinport, 1.4 16V Twinport LPG, 1.6, 1.6 16V, 1.6 Turbo, 1.7 CDTI, 1.7 DTI, 1.8		E	'E	'H	BS6103
Rod/Strut, stabiliser	1.3CDTI, 1.4 16V Twinport, 1.4 16V Twinport LPG, 1.6, 1.6 16V, 1.6 Turbo, 1.7 CDTI, 1.7 DTI, 1.8	Material: Metal	E	'E	'H	CTR5771
Top Strut Mounting	1.6, 1.6 16V, 1.7 CDTI, 1.7 DTI	Soft Version; without ball bearing	E	'E	'H	MO6848

MERIVA B

06/2010 →

Ball Joint	1.3 CDTI, 1.4, 1.7 CDTI	with add-on material	E	'E	'H	CJ1089
------------	-------------------------	----------------------	---	----	----	--------

ZAFIRA A (F75_)













04/1999 → 06/2005

Ball Joint	1.6, 1.6 16V, 1.6 CNG, 1.8, 1.8 16V, 2.0 DI 16V, 2.0 DTI 16V, 2.0 OPC, 2.2 16V, 2.2 DTI 16V	with add-on material	E	'E	'H	CJ1089
Rod/Strut, stabiliser	1.6, 1.6 16V, 1.6 CNG, 1.8, 1.8 16V, 2.0 DI 16V, 2.0 DTI 16V, 2.0 OPC, 2.2 16V, 2.2 DTI 16V	Alternative Repair Kit: G7-1517; Material: Plastic	E	'E	'H	CTR2462
Tie Rod End	1.6, 1.6 16V, 1.6 CNG, 1.8, 1.8 16V, 2.0 DI 16V, 2.0 DTI 16V, 2.0 OPC, 2.2 16V, 2.2 DTI 16V		E	'E	'H	CTR5170
Top Strut Mounting	1.6, 1.6 16V, 1.6 CNG, 1.8, 1.8 16V, 2.0 DI 16V, 2.0 DTI 16V, 2.0 OPC, 2.2 16V, 2.2 DTI 16V	Soft Version; without ball bearing	E	'E	'H	MO6848
Tie Rod Axle Joint	1.6 16V, 1.6 CNG, 1.8 16V, 2.0 DI 16V, 2.0 DTI 16V, 2.0 OPC, 2.2 16V, 2.2 DTI 16V		E	'E	'H	RE5547



ZAFIRA B (A05)

07/2005 →

Ball Joint	1.6, 1.6 CNG, 1.6 CNG Turbo, 1.7 CDTI, 1.8, 1.9 CDTI, 2.0, 2.2	with add-on material	E	'E	'H	CJ1089
Rod/Strut, stabiliser	1.6, 1.6 CNG, 1.6 CNG Turbo, 1.7 CDTI, 1.8, 1.9 CDTI, 2.0, 2.2	Alternative Repair Kit: G7-1517; Material: Plastic; for vehicles without IDS suspension	E	'E	'H	CTR2462

						
BS6102	BS6103	CJ1089	CJ1501L	CJ1501R	CJ951	CTR2462
Ref.Nr.: 352309	Ref.Nr.: 24430103	Ref.Nr.: 90542995	Ref.Nr.: 0352077	Ref.Nr.: 0352192	Ref.Nr.: 1603163	Ref.Nr.: 350614
						
CTR5170	CTR5427L	CTR5427R	CTR5643	CTR5771	MO6848	RE5547
Ref.Nr.: 26059294	Ref.Nr.: 90350447	Ref.Nr.: 0324054	Ref.Nr.: 4400040	Ref.Nr.: 90496116	Ref.Nr.: 344523	Ref.Nr.: 1603213

PEUGEOT

Article Description			Fitting Position	Article No.
206 CC (2D)			09/2000 →	
Tie Rod Axle Joint	1.6 16V, 1.6 HDi 110, 2.0 S16		E	'E 'H RE5651
206 Hatchback (2A/C)			08/1998 → 11/2001	
Tie Rod Axle Joint	1.1, 1.1 i, 1.4 16V, 1.4 HDi eco 70, 1.4 i, 1.6 16V, 1.6 HDi 110, 1.6 i, 1.9 D, 2.0 HDi 90, 2.0 RC, 2.0 S16		E	'E 'H RE5651
206 SW (2E/K)			07/2002 →	
Tie Rod Axle Joint	1.1, 1.4, 1.4 16V, 1.4 HDi, 1.6 16V, 1.6 HDi 110, 2.0 16V, 2.0 HDi		E	'E 'H RE5651
206 Saloon			03/2007 →	
Tie Rod Axle Joint	1.4, 1.6 16V		E	'E 'H RE5651
307 (3A/C)			08/2000 →	
Rod/Strut, stabiliser	1.4 16V, 1.4 HDi, 1.6 HDi, 1.6 HDi 110, 2.0 16V, 2.0 HDi 135	Material: Steel	E	'E 'H CTR6130
Rod/Strut, stabiliser	1.4, 1.6 16V, 2.0 16V, 2.0 HDi 110, 2.0 HDi 90	01/2001 →; Material: Steel	E	'E 'H CTR6130
307 Estate (3E)			03/2002 → 09/2003	
Rod/Strut, stabiliser	1.4, 1.4 16V, 1.4 HDi, 1.6 16V, 1.6 HDi, 1.6 HDi 110, 2.0, 2.0 16V, 2.0 HDi 110, 2.0 HDi 135, 2.0 HDi 90	Material: Steel	E	'E 'H CTR6130
307 CC (3B)			10/2003 →	
Rod/Strut, stabiliser	1.6 16V, 2.0 16V, 2.0 HDi 135	Material: Steel	E	'E 'H CTR6130
307 SW (3H)			03/2002 → 09/2003	
Rod/Strut, stabiliser	1.4, 1.4 16V, 1.6 16V, 1.6 HDi 110, 2.0 16V, 2.0 HDi 110, 2.0 HDi 135, 2.0 HDi 90	Material: Steel	E	'E 'H CTR6130
EXPERT (224)			07/2000 →	
Rod/Strut, stabiliser	2.0 HDi	01/2001 →; Material: Steel	E	'E 'H CTR6130



Article Description			Fitting Position	Article No.
---------------------	---	---	------------------	-------------

924

11/1975 → 08/1989

Track Control Arm	2.0, 2.0 Carrera GT, 2.0 Turbo	ch.F92CN402198, F93CN100306 →; with rubber mounting, without ball joint	E	'E	'H	CJ108
Track Control Arm	2.5 S	with rubber mounting, without ball joint	E	'E	'H	CJ108
Ball Joint	2.0	01/1978 →	E	'E	'H	CJ832
Ball Joint	2.0 Carrera GT, 2.0 Turbo, 2.5 S		E	'E	'H	CJ832

944

06/1981 → 07/1987

Track Control Arm	2.5	→ 01/1985; with rubber mounting, without ball joint	E	'E	'H	CJ108
Ball Joint	2.5	→ 01/1985	E	'E	'H	CJ832

	
<p>CJ108</p>	<p>CJ832</p>
<p>Ref.Nr.: 171407153D</p>	<p>Ref.Nr.: 171407365F</p>

RENAULT

Article Description			Fitting Position	Article No.
---------------------	---	---	------------------	-------------

CLIO Mk II (BB0/1/2_, CB0/1/2_) 09/1998 → 02/2010

Control Arm-/Trailing Arm Bush	1.2, 1.4, 1.4 16V, 1.6, 1.6 16V, 1.9 D, 1.9 dTi, 2.0 16V Sport		E	'E	'H	BS6002
Stabiliser Set	1.0, 1.2, 1.2 16V, 1.2 LPG, 1.4, 1.4 16V, 1.5 dCi, 1.6, 1.6 16V, 1.6 Flex, 1.6 Hi-Flex, 1.9 D, 1.9 dTi, 2.0 16V Sport, 3.0 V6 Sport	→ 09/2008	E			BS8131
Tie Rod End	1.0, 1.2, 1.2 16V, 1.2 LPG, 1.4, 1.4 16V, 1.5 dCi, 1.6, 1.6 16V, 1.6 Hi-Flex, 1.9 D, 1.9 dTi, 2.0 16V Sport, 3.0 V6 Sport	01/2000 →; Manufacturer Restriction: SMI, TRW	E	'E		CTR5726L
Tie Rod End	1.0, 1.2, 1.2 16V, 1.2 LPG, 1.4, 1.4 16V, 1.5 dCi, 1.6, 1.6 16V, 1.6 Hi-Flex, 1.9 D, 1.9 dTi, 2.0 16V Sport, 3.0 V6 Sport	01/2000 →; Manufacturer Restriction: SMI, TRW	E		'H	CTR5726R

CLIO Mk II Box (SB0/1/2_) 09/1998 → 10/2004

Stabiliser Set	1.1, 1.2, 1.5 dCi, 1.9 D, 1.9 DTi	→ 09/2008	E			BS8131
Tie Rod End	1.1, 1.2, 1.5 dCi, 1.9 D, 1.9 DTi	01/2000 →; Manufacturer Restriction: SMI, TRW	E	'E		CTR5726L
Tie Rod End	1.1, 1.2, 1.5 dCi, 1.9 D, 1.9 DTi	01/2000 →; Manufacturer Restriction: SMI, TRW	E		'H	CTR5726R

CLIO Mk III (BR0/1, CR0/1) 05/2005 → 08/2010

Stabiliser Set	1.6 Hi-Flex		E			BS8131
Control Arm-/Trailing Arm Bush	1.2, 1.2 16V, 1.2 16V Hi-Flex, 1.4 16V, 1.5 dCi, 1.6 16V, 1.6 16V GT, 2.0 16V, 2.0 16V Sport		E	'E	'H	BS8147
Control Arm-/Trailing Arm Bush	1.2 16V, 1.2 16V Hi-Flex, 1.4 16V, 1.5 dCi, 1.6 16V, 2.0 16V, 2.0 16V Sport		E	'E	'H	BS8218
Ball Joint	1.4 16V, 1.5 dCi, 1.6 16V	with lock ring	E	'E	'H	CJ1145
Track Control Arm	1.2, 1.2 16V, 1.2 16V Hi-Flex, 1.4 16V, 1.5 dCi, 1.6 16V, 1.6 16V GT, 2.0 16V	Material: Sheet Steel; with ball joint, with rubber mounting	E	'E		CJ299L
Track Control Arm	1.2, 1.2 16V, 1.2 16V Hi-Flex, 1.4 16V, 1.5 dCi, 1.6 16V, 1.6 16V GT, 2.0 16V	Material: Sheet Steel; with ball joint, with rubber mounting	E		'H	CJ299R
Tie Rod End	1.2, 1.2 16V, 1.2 16V Hi-Flex, 1.4 16V, 1.5 dCi, 1.6 16V, 1.6 16V GT, 2.0 16V	Manufacturer Restriction: SMI, TRW	E	'E		CTR5726L
Tie Rod End	1.2, 1.2 16V, 1.2 16V Hi-Flex, 1.4 16V, 1.5 dCi, 1.6 16V, 1.6 16V GT, 2.0 16V	Manufacturer Restriction: SMI, TRW	E		'H	CTR5726R
Rod/Strut, stabiliser	1.2 16V, 1.4 16V, 1.5 dCi, 1.6 16V, 2.0 16V Sport		E	'E	'H	CTR5770

CLIO Mk IV 11/2012 →

Control Arm-/Trailing Arm Bush	0.9TCe 90, 1.2 16V, 1.2TCe 120, 1.5 dCi 75, 1.5 dCi 90		E			BS6819
--------------------------------	--	--	---	--	--	--------

GRAND SCÉNIC II (JM0/1_) 04/2004 →

Control Arm-/Trailing Arm Bush	1.5 dCi, 1.6, 1.9 dCi, 2.0, 2.0 dCi		E			BS6819
Ball Joint	1.5 dCi, 1.6, 1.9 dCi, 2.0	with lock ring	E	'E	'H	CJ1145
Tie Rod Axle Joint	1.5 dCi, 1.6, 1.9 dCi, 2.0		E	'E	'H	RE5902

KANGOO (KC0/1_) 08/1997 → 06/2010

Control Arm-/Trailing Arm Bush	1.2, 1.4, 1.9 dTi, D 55 1.9, D 65 1.9		E	'E	'H	BS6002
Stabiliser Set	1.2, 1.2 16V, 1.4, 1.5 dCi, 1.6, 1.6 16V, 1.6 16V 4x4, 1.9 dCi 4x4, 1.9 dTi, 1.9 RXED, D55 1.9, D65 1.9, Elect'road		E			BS8131
Tie Rod End	1.2	→ 03/2001; Manufacturer Restriction: SMI, TRW; Type: KC01, KC0F; for vehicles with power steering	E	'E		CTR5726L
Tie Rod End	1.2	02/1999 →; Manufacturer Restriction: SMI, TRW; Type: KC0A; for vehicles without power steering	E	'E		CTR5726L
Tie Rod End	1.2	Manufacturer Restriction: SMI, TRW; Type: KC0K; for vehicles with power steering, for vehicles without power steering	E	'E		CTR5726L

						
BS6002	BS6819	BS8131	BS8147	BS8218	CJ1145	CJ299L
Ref.Nr.: 7700424399	Ref.Nr.: 8200041166	Ref.Nr.: 7700799404	Ref.Nr.: 54501BC41A	Ref.Nr.: 54570AX600	Ref.Nr.: 8200679067	Ref.Nr.: 8200744091
						
CJ299R	CTR5726L	CTR5726R	CTR5770	RE5902		
Ref.Nr.: 8200744092	Ref.Nr.: 7701476760	Ref.Nr.: 7701475843	Ref.Nr.: 8200127308	Ref.Nr.: 7701474448		

Article Description			Fitting Position	Article No.
---------------------	---	---	------------------	-------------

KANGOO (KC0/1_)

08/1997 → 06/2010

Tie Rod End	1.2 16V	Manufacturer Restriction: SMI, TRW; Type: KC05, KC06, KC0T, KC0W; for vehicles with power	E	E	CTR5726L
Tie Rod End	1.4	02/1999 →; Manufacturer Restriction: SMI, TRW; Type: KC0C, KC0H; for vehicles with power steering, for vehicles without power steering	E	E	CTR5726L
Tie Rod End	1.4	Manufacturer Restriction: SMI, TRW; Type: KC0B, KC0M; for vehicles with power steering, for vehicles without power steering	E	E	CTR5726L
Tie Rod End	1.5 dCi	Engine Code: K9K 700, K9K702; Manufacturer Restriction: SMI, TRW	E	E	CTR5726L
Tie Rod End	1.5 dCi, 1.6, 1.6 16V, 1.6 16V bivalent, 1.9 dCi 4x4, 1.9 dTi, 1.9 RXED, D 55 1.9	Manufacturer Restriction: SMI, TRW; for vehicles with power steering, for vehicles without power steering	E	E	CTR5726L
Tie Rod End	1.6 16V 4x4	Manufacturer Restriction: SMI, TRW; Type: KC0L, KC0P, KC0S; for vehicles with power steering, for vehicles without power steering	E	E	CTR5726L
Tie Rod End	D 65 1.9	02/1999 →; Manufacturer Restriction: SMI, TRW; Type: KC0E; for vehicles with power steering, for vehicles without power steering	E	E	CTR5726L
Tie Rod End	D 65 1.9	Manufacturer Restriction: SMI, TRW; Type: KC02, KC0J, KC0N; for vehicles with power steering, for vehicles without power steering	E	E	CTR5726L
Tie Rod End	Elect'road RE	Manufacturer Restriction: SMI, TRW	E	E	CTR5726L
Tie Rod End	1.2	→ 03/2001; Manufacturer Restriction: SMI, TRW; Type: KC01, KC0F; for vehicles with power steering	E	H	CTR5726R
Tie Rod End	1.2	02/1999 →; Manufacturer Restriction: SMI, TRW; Type: KC0A; for vehicles without power steering	E	H	CTR5726R
Tie Rod End	1.2	Manufacturer Restriction: SMI, TRW; Type: KC0F; for vehicles without power steering	E	H	CTR5726R
Tie Rod End	1.2	Manufacturer Restriction: SMI, TRW; Type: KC0K; for vehicles with power steering, for vehicles without power steering	E	H	CTR5726R
Tie Rod End	1.2 16V	Manufacturer Restriction: SMI, TRW; Type: KC05, KC06, KC0T, KC0W; for vehicles with power	E	H	CTR5726R
Tie Rod End	1.4	02/1999 →; Manufacturer Restriction: SMI, TRW; Type: KC0C, KC0H; for vehicles with power steering, for vehicles without power steering	E	H	CTR5726R
Tie Rod End	1.4	Manufacturer Restriction: SMI, TRW; Type: KC0B, KC0M; for vehicles with power steering, for vehicles without power steering	E	H	CTR5726R
Tie Rod End	1.5 dCi	Engine Code: K9K 700, K9K702; Manufacturer Restriction: SMI, TRW	E	H	CTR5726R
Tie Rod End	1.5 dCi, 1.6, 1.6 16V, 1.6 16V bivalent, 1.9 dCi 4x4, 1.9 dTi, 1.9 RXED, D 55 1.9	Manufacturer Restriction: SMI, TRW; for vehicles with power steering, for vehicles without power steering	E	H	CTR5726R
Tie Rod End	1.6 16V 4x4	Manufacturer Restriction: SMI, TRW; Type: KC0L, KC0P, KC0S; for vehicles with power steering, for vehicles without power steering	E	H	CTR5726R
Tie Rod End	D 65 1.9	02/1999 →; Manufacturer Restriction: SMI, TRW; Type: KC0E; for vehicles with power steering, for vehicles without power steering	E	H	CTR5726R
Tie Rod End	D 65 1.9	Manufacturer Restriction: SMI, TRW; Type: KC02, KC0J, KC0N; for vehicles with power steering, for vehicles without power steering	E	H	CTR5726R
Tie Rod End	Elect'road RE	Manufacturer Restriction: SMI, TRW	E	H	CTR5726R

	
CTR5726L	CTR5726R
Ref.Nr.: 7701476760	Ref.Nr.: 7701475843

RENAULT





Article Description			Fitting Position	Article No.
---------------------	---	---	------------------	-------------

KANGOO Express (FC0/1_)

08/1997 → 06/2003

Control Arm-/Trailing Arm Bush	1.2 , 1.4 , 1.9 dTi , D 55 1.9 , D 65 1.9		E	'E	H	BS6002
Stabiliser Set	1.2, 1.2 16V, 1.2 BiFuel, 1.4, 1.5 dCi, 1.6 16V, 1.6 16V 4x4 , 1.9 D, 1.9 dCi , 1.9 dCi 4x4 , 1.9 dTi , D 55 1.9 , D 65 1.9		E			BS8131
Tie Rod End	1.0, 1.6 16V, 1.6 16V bivalent, 1.9 D , 1.9 dCi 4x4	Manufacturer Restriction: SMI, TRW	E	'E		CTR5726L
Tie Rod End	1.2	02/1999 →; Manufacturer Restriction: SMI, TRW; Type: FC0A, FC0F; for vehicles with power steering, for vehicles without power steering	E	'E		CTR5726L
Tie Rod End	1.2 , 1.5 dCi	Manufacturer Restriction: SMI, TRW; Type: FC01; for vehicles with power steering, for vehicles without power steering	E	'E		CTR5726L
Tie Rod End	1.2 16V, 1.6 16V 4x4 , 1.9 dCi 4x4 , 1.9 dTi	Manufacturer Restriction: SMI, TRW; for vehicles with power steering, for vehicles without power steering	E	'E		CTR5726L
Tie Rod End	1.2 BiFuel	02/1999 →; Engine Code: D7F 710; Manufacturer Restriction: SMI, TRW	E	'E		CTR5726L
Tie Rod End	1.4	02/1999 →; Manufacturer Restriction: SMI, TRW; Type: FC0C, FC0H; for vehicles with power steering, for vehicles without power steering	E	'E		CTR5726L
Tie Rod End	1.4	Manufacturer Restriction: SMI, TRW; Type: FC0B, FC0M; for vehicles with power steering, for vehicles without power steering	E	'E		CTR5726L
Tie Rod End	1.5 dCi	Manufacturer Restriction: SMI, TRW; Type: FC0A, FC0F; for vehicles with power steering, for vehicles without power steering	E	'E		CTR5726L
Tie Rod End	1.9 dCi	Engine Code: F9Q 790; Manufacturer Restriction: SMI, TRW	E	'E		CTR5726L
Tie Rod End	D 55 1.9	→ 02/1999; Manufacturer Restriction: SMI, TRW; for vehicles with power steering, for vehicles without power steering	E	'E		CTR5726L
Tie Rod End	D 65 1.9	→ 02/1999; Manufacturer Restriction: SMI, TRW; Type: FC02, FC0E; for vehicles with power steering, for vehicles without power steering	E	'E		CTR5726L
Tie Rod End	D 65 1.9	Manufacturer Restriction: SMI, TRW; Type: FC0J, FC0N; for vehicles with power steering, for vehicles without power steering	E	'E		CTR5726L
Tie Rod End	1.0, 1.6 16V, 1.6 16V bivalent, 1.9 D , 1.9 dCi 4x4	Manufacturer Restriction: SMI, TRW	E		H	CTR5726R
Tie Rod End	1.2	02/1999 →; Manufacturer Restriction: SMI, TRW; Type: FC0A, FC0F; for vehicles with power steering, for vehicles without power steering	E		H	CTR5726R
Tie Rod End	1.2 , 1.5 dCi	Manufacturer Restriction: SMI, TRW; Type: FC01; for vehicles with power steering, for vehicles without power steering	E		H	CTR5726R
Tie Rod End	1.2 16V , 1.5 dCi , 1.6 16V 4x4 , 1.9 dCi 4x4 , 1.9 dTi	Manufacturer Restriction: SMI, TRW; for vehicles with power steering, for vehicles without power steering	E		H	CTR5726R
Tie Rod End	1.2 BiFuel	02/1999 →; Engine Code: D7F 710; Manufacturer Restriction: SMI, TRW	E		H	CTR5726R
Tie Rod End	1.4	02/1999 →; Manufacturer Restriction: SMI, TRW; Type: FC0C, FC0H; for vehicles with power steering, for vehicles without power steering	E		H	CTR5726R
Tie Rod End	1.4	Manufacturer Restriction: SMI, TRW; Type: FC0B, FC0M; for vehicles with power steering, for vehicles without power steering	E		H	CTR5726R
Tie Rod End	1.5 dCi	Manufacturer Restriction: SMI, TRW; Type: FC0A, FC0F; for vehicles with power steering, for vehicles without power steering	E		H	CTR5726R

RENAULT

			
BS6002	BS8131	CTR5726L	CTR5726R
Ref.Nr.: 7700424399	Ref.Nr.: 7700799404	Ref.Nr.: 7701476760	Ref.Nr.: 7701475843

Article Description			Fitting Position	Article No.
---------------------	---	---	------------------	-------------

KANGOO Express (FC0/1_)

08/1997 → 06/2003

Tie Rod End	1.9 dCi	Engine Code: F9Q 790; Manufacturer Restriction: SMI, TRW	E		H	CTR5726R
Tie Rod End	D 55 1.9	→ 02/1999; Manufacturer Restriction: SMI, TRW; for vehicles with power steering, for vehicles without power steering	E		H	CTR5726R
Tie Rod End	D 65 1.9	→ 02/1999; Manufacturer Restriction: SMI, TRW; Type: FC02, FC0E; for vehicles with power steering, for vehicles without power steering	E		H	CTR5726R
Tie Rod End	D 65 1.9	Manufacturer Restriction: SMI, TRW; Type: FC0J, FC0N; for vehicles with power steering, for vehicles without power steering	E		H	CTR5726R

KANGOO / GRAND KANGOO (KW0/1_)

02/2008 →

Control Arm-/Trailing Arm Bush	1.5 dCi , 1.5 dCi 110, 1.6, 1.6 16V , 1.6 16V Hi-Flex		E			BS6819
--------------------------------	---	--	---	--	--	--------

KANGOO BE BOP (KW0/1_)

02/2009 →

Control Arm-/Trailing Arm Bush	1.5 dCi , 1.5 dCi 75, 1.6		E			BS6819
--------------------------------	---------------------------	--	---	--	--	--------

KANGOO Express (FW0/1_)

02/2008 →

Control Arm-/Trailing Arm Bush	1.5 dCi , 1.5 dCi 110, 1.5 dCi 75, 1.5 dCi 85, 1.5 dCi 90, 1.6, 1.6 16V, 1.6 16V LPG, Z.E.		E			BS6819
--------------------------------	--	--	---	--	--	--------

LOGAN I (LS_)

09/2004 →

Tie Rod End	1.4, 1.5 dCi, 1.6		E		E	CTR5985L
Tie Rod End	1.4, 1.5 dCi, 1.6		E		H	CTR5985R
Tie Rod Axle Joint	1.4, 1.5 dCi, 1.6		E		E H	RE5986

MEGANE I (BA0/1_)

01/1996 → 08/2003

Tie Rod End	1.4 16V, 1.4 Eco, 1.6 16V, 1.6e, 1.6i, 1.6 LPG, 1.8 16V, 1.9 D Eco, 1.9 dCi, 1.9 dT, 1.9 dTi, 1.9 TDI, 2.0 i	→ 10/2002; Manufacturer Restriction: SMI, TRW	E		E	CTR5726L
Tie Rod End	1.4 e, 2.0 16V	03/1999 →; → 10/2002; Manufacturer Restriction: SMI, TRW	E		E	CTR5726L
Tie Rod End	1.9 DCi	Engine Code: F9Q 732; Manufacturer Restriction: SMI, TRW	E		E	CTR5726L
Tie Rod End	1.4 16V, 1.4 Eco, 1.6 16V, 1.6e, 1.6i, 1.6 LPG, 1.8 16V, 1.9 D Eco, 1.9 dCi, 1.9 dT, 1.9 dTi, 1.9 TDI, 2.0 i	→ 10/2002; Manufacturer Restriction: SMI, TRW	E		H	CTR5726R
Tie Rod End	1.4 e, 2.0 16V	03/1999 →; → 10/2002; Manufacturer Restriction: SMI, TRW	E		H	CTR5726R
Tie Rod End	1.9 DCi	Engine Code: F9Q 732; Manufacturer Restriction: SMI, TRW	E		H	CTR5726R

MEGANE I Cabriolet (EA0/1_)









10/1996 → 08/2003

Ball Joint	2.0 16V	with lock ring	E		E H	CJ1145
Tie Rod End	1.4 16V , 1.6 16V , 1.6 e , 2.0 16V, 2.0 16V IDE , 2.0 i	Manufacturer Restriction: SMI, TRW	E		E	CTR5726L
Tie Rod End	2.0 , 2.0 16V	03/1999 →; Manufacturer Restriction: SMI, TRW	E		E	CTR5726L
Tie Rod End	1.4 16V , 1.6 16V , 1.6 e , 2.0 16V, 2.0 16V IDE , 2.0 i	Manufacturer Restriction: SMI, TRW	E		H	CTR5726R
Tie Rod End	2.0 , 2.0 16V	03/1999 →; Manufacturer Restriction: SMI, TRW	E		H	CTR5726R
Tie Rod Axle Joint	2.0 16V		E		E H	RE5902

MEGANE I Classic (LA0/1_)

09/1996 → 08/2003

Ball Joint	1.6 16V	with lock ring	E		E H	CJ1145
------------	---------	----------------	---	--	-----	--------

						
BS6819	CJ1145	CTR5726L	CTR5726R	CTR5985L	CTR5985R	RE5902
Ref.Nr.: 8200041166	Ref.Nr.: 8200679067	Ref.Nr.: 7701476760	Ref.Nr.: 7701475843	Ref.Nr.: 6001550442	Ref.Nr.: 6001547611	Ref.Nr.: 7701474448
						
RE5986						
Ref.Nr.: 6001550441						

RENAULT

Article Description			Fitting Position	Article No.
---------------------	---	---	------------------	-------------

MEGANE I Classic (LA0/1_) 09/1996 → 08/2003

Tie Rod End	1.416V, 1.616V, 1.6e, 1.6i, 1.816V, 1.9D, 1.9dCi, 1.9dTi, 2.0i	03/1999 →; Manufacturer Restriction: SMI, TRW	E	E		CTR5726L
Tie Rod End	2.0 RT	Engine Code: F3R750, F3R751, F3R752, F3R797, F3R798; Manufacturer Restriction: SMI, TRW	E	E		CTR5726L
Tie Rod End	1.416V, 1.616V, 1.6e, 1.6i, 1.816V, 1.9D, 1.9dCi, 1.9dTi, 2.0i	03/1999 →; Manufacturer Restriction: SMI, TRW	E		H	CTR5726R
Tie Rod End	2.0 RT	Engine Code: F3R750, F3R751, F3R752, F3R797, F3R798; Manufacturer Restriction: SMI, TRW	E		H	CTR5726R

MEGANE II (BM0/1_, CM0/1_) 11/2002 → 12/2009

Control Arm-/Trailing Arm Bush	1.416V, 1.5dCi, 1.6, 1.616V, 1.6Flex-Fuel, 1.9dCi, 2.0, 2.016V Turbo, 2.0dCi, 2.0 Renault Sport		E			BS6819
Ball Joint	1.416V, 1.5dCi, 1.616V, 1.9dCi, 2.016V Turbo, 2.0dCi, 2.0 Renault Sport	with lock ring	E	E	H	CJ1145
Tie Rod Axle Joint	1.416V, 1.5dCi, 1.616V, 1.9dCi, 2.016V Turbo, 2.0dCi, 2.0 Renault Sport		E	E	H	RE5902

MEGANE II Coupé-Cabriolet (EM0/1_) 09/2003 → 12/2009

Control Arm-/Trailing Arm Bush	1.5dCi, 1.6, 1.616V, 1.9dCi, 2.0, 2.016V Turbo, 2.0dCi		E			BS6819
Ball Joint	1.5dCi, 1.6, 1.616V, 1.9dCi, 2.0, 2.016V Turbo, 2.0dCi	with lock ring	E	E	H	CJ1145
Tie Rod Axle Joint	1.5dCi, 1.6, 1.616V, 1.9dCi, 2.0, 2.016V Turbo, 2.0dCi		E	E	H	RE5902

MEGANE II SALOON (LM0/1_) 01/2003 → 12/2005

Control Arm-/Trailing Arm Bush			E	E	H	BS6819
Ball Joint			E	E	H	CJ1145
Tie Rod Axle Joint			E	E	H	RE5902

MEGANE II Sport Tourer (KM0/1_) 08/2003 → 08/2009

Control Arm-/Trailing Arm Bush	1.4, 1.5dCi, 1.6, 1.616V, 1.616V Hi-Flex, 1.9dCi, 2.0, 2.0dCi		E			BS6819
Ball Joint	1.4, 1.5dCi, 1.6, 1.616V, 1.9dCi, 2.0, 2.0dCi	with lock ring	E	E	H	CJ1145
Tie Rod Axle Joint	1.4, 1.5dCi, 1.6, 1.616V, 1.9dCi, 2.0, 2.0dCi		E	E	H	RE5902

MEGANE Scenic (JA0/1_) 10/1996 → 10/1999

Tie Rod End	1.4i, 1.616V, 1.6e, 1.6i, 1.9D, 1.9dT, 1.9dTi, 2.0i, 2.0 RXE 4x4	Manufacturer Restriction: SMI, TRW	E	E		CTR5726L
Tie Rod End	1.4i, 1.616V, 1.6e, 1.6i, 1.9D, 1.9dT, 1.9dTi, 2.0i, 2.0 RXE 4x4	Manufacturer Restriction: SMI, TRW	E		H	CTR5726R

MODUS / GRAND MODUS (F/JP0_) 09/2004 →

Control Arm-/Trailing Arm Bush	1.2, 1.216V, 1.216V Hi-Flex, 1.4, 1.5dCi, 1.6		E	E	H	BS8147
Control Arm-/Trailing Arm Bush	1.2, 1.216V, 1.216V Hi-Flex, 1.4, 1.5dCi, 1.6		E	E	H	BS8218
Ball Joint	1.2, 1.4, 1.6	with lock ring	E	E	H	CJ1145
Track Control Arm	1.2, 1.216V, 1.216V Hi-Flex, 1.4, 1.5dCi, 1.5dCi 90, 1.6	Material: Sheet Steel; with ball joint, with rubber mounting	E	E		CJ299L
Track Control Arm	1.2, 1.216V, 1.216V Hi-Flex, 1.4, 1.5dCi, 1.5dCi 90, 1.6	Material: Sheet Steel; with ball joint, with rubber mounting	E		H	CJ299R
Tie Rod End	1.2, 1.216V, 1.216V Hi-Flex, 1.4, 1.5dCi, 1.5dCi 75, 1.5dCi 90, 1.6	Manufacturer Restriction: SMI, TRW	E	E		CTR5726L
Tie Rod End	1.2, 1.216V, 1.216V Hi-Flex, 1.4, 1.5dCi, 1.5dCi 75, 1.5dCi 90, 1.6	Manufacturer Restriction: SMI, TRW	E		H	CTR5726R

						
BS6819	BS8147	BS8218	CJ1145	CJ299L	CJ299R	CTR5726L
Ref.Nr.: 8200041166	Ref.Nr.: 54501BC41A	Ref.Nr.: 54570AX600	Ref.Nr.: 8200679067	Ref.Nr.: 8200744091	Ref.Nr.: 8200744092	Ref.Nr.: 7701476760
						
CTR5726R	RE5902					
Ref.Nr.: 7701475843	Ref.Nr.: 7701474448					

Article Description			Fitting Position	Article No.
---------------------	---	---	------------------	-------------

MODUS / GRAND MODUS (F/JP0_)

09/2004 →

Rod/Strut, stabiliser	1.2, 1.4, 1.5 dCi, 1.6		E	'E 'H	CTR5770
-----------------------	------------------------	--	---	-------	---------

SANDERO/STEPWAY I

01/2007 →

Ball Joint	1.4, 1.6		E	'E 'H	CJ1145
Tie Rod End	1.4, 1.6		E	'E	CTR5985L
Tie Rod End	1.4, 1.6		E	'H	CTR5985R
Tie Rod Axle Joint	1.4, 1.6		E	'E 'H	RE5986

SCÉNIC I (JA0/1_)

09/1999 → 09/2003

Tie Rod End	1.4 16V, 1.6, 1.6 16V, 1.6 BiFuel, 1.8 16V, 1.8 4x4, 1.9 D, 1.9 dCi, 1.9 dCi RX4, 1.9 dTi, 2.0 16V, 2.0 16V RX4	Manufacturer Restriction: SMI, TRW	E	'E	CTR5726L
Tie Rod End	1.4 16V, 1.6, 1.6 16V, 1.6 BiFuel, 1.8 16V, 1.8 4x4, 1.9 D, 1.9 dCi, 1.9 dCi RX4, 1.9 dTi, 2.0 16V, 2.0 16V RX4	Manufacturer Restriction: SMI, TRW	E	'H	CTR5726R

SCÉNIC II (JM0/1_)

06/2003 →

Control Arm-/Trailing Arm Bush	1.4, 1.5 dCi, 1.6, 1.6 16V, 1.9 D, 1.9 dCi, 2.0, 2.0 16V Turbo, 2.0 dCi		E		BS6819
Ball Joint	1.4, 1.5 dCi, 1.6, 1.9 dCi, 2.0, 2.0 16V Turbo, 2.0 dCi	with lock ring	E	'E 'H	CJ1145
Tie Rod Axle Joint	1.4, 1.5 dCi, 1.6, 1.6 16V, 1.9 dCi, 2.0, 2.0 16V Turbo, 2.0 dCi		E	'E 'H	RE5902

TWINGO I (C06_)

05/1996 → 06/2007

Tie Rod End	1.2 LPG	Engine Code: D7F 702; Manufacturer Restriction: SMI, TRW	E	'E	CTR5726L
Tie Rod End	1.2, 1.2 16V	12/1999 →; Manufacturer Restriction: SMI, TRW	E	'E	CTR5726L
Tie Rod End	1.2 LPG	Engine Code: D7F 702; Manufacturer Restriction: SMI, TRW	E	'H	CTR5726R
Tie Rod End	1.2, 1.2 16V	12/1999 →; Manufacturer Restriction: SMI, TRW	E	'H	CTR5726R

TWINGO I Van (S06_)









05/1996 →

Tie Rod End	1.2	12/1999 →; Manufacturer Restriction: SMI, TRW	E	'E	CTR5726L
Tie Rod End	1.2	12/1999 →; Manufacturer Restriction: SMI, TRW	E	'H	CTR5726R

TWINGO II (CN0_)

03/2007 →

Tie Rod End	1.2, 1.2 16V, 1.2 TCe 100, 1.2 Turbo, 1.5 dCi, 1.5 dCi 75, 1.5 dCi 90, 1.6 RS	Manufacturer Restriction: SMI, TRW	E	'E	CTR5726L
Tie Rod End	1.2, 1.2 16V, 1.2 TCe 100, 1.2 Turbo, 1.5 dCi, 1.5 dCi 75, 1.5 dCi 90, 1.6 RS	Manufacturer Restriction: SMI, TRW	E	'H	CTR5726R

						
BS6819	CJ1145	CTR5726L	CTR5726R	CTR5770	CTR5985L	CTR5985R
Ref.Nr.: 8200041166	Ref.Nr.: 8200679067	Ref.Nr.: 7701476760	Ref.Nr.: 7701475843	Ref.Nr.: 8200127308	Ref.Nr.: 6001550442	Ref.Nr.: 6001547611
						
RE5902	RE5986					
Ref.Nr.: 7701474448	Ref.Nr.: 6001550441					

Article Description			Fitting Position	Article No.
---------------------	---	---	------------------	-------------

900 Mk II

07/1993 → 02/1998

Tie Rod End	2.0 -16 Turbo, 2.0 i, 2.3 -16, 2.5 -24 V6		E	'E		CTR5427L
Tie Rod End	2.0 -16 Turbo, 2.0 i, 2.3 -16, 2.5 -24 V6		E		'H	CTR5427R
Rod/Strut, stabiliser	2.0 -16 Turbo, 2.0 i, 2.3 -16, 2.5 -24 V6	for OE: 350 263	E	'E	'H	CTR5643

900 Mk II Convertible

12/1993 → 02/1998

Tie Rod End	2.0 -16 Turbo, 2.0 i, 2.3 -16, 2.5 -24 V6		E	'E		CTR5427L
Tie Rod End	2.0 -16 Turbo, 2.0 i, 2.3 -16, 2.5 -24 V6		E		'H	CTR5427R
Rod/Strut, stabiliser	2.0 -16 Turbo, 2.0 i, 2.3 -16, 2.5 -24 V6	for OE: 350 263	E	'E	'H	CTR5643

900 Mk II Coupe

12/1993 → 02/1998

Tie Rod End	2.0 -16 Turbo, 2.0 i, 2.3 -16, 2.5 -24 V6		E	'E		CTR5427L
Tie Rod End	2.0 -16 Turbo, 2.0 i, 2.3 -16, 2.5 -24 V6		E		'H	CTR5427R
Rod/Strut, stabiliser	2.0 -16 Turbo, 2.0 i, 2.3 -16, 2.5 -24 V6	for OE: 350 263	E	'E	'H	CTR5643

9-3 (YS3D)

02/1998 → 09/2002

Tie Rod End	2.0i, 2.0SE Turbo, 2.0 Turbo, 2.2 TiD, 2.3, 2.3i, 2.3 Turbo		E	'E		CTR5427L
Tie Rod End	2.0 i, 2.0 SE Turbo, 2.0 Turbo, 2.2 TiD, 2.3 i, 2.3 Turbo		E		'H	CTR5427R
Rod/Strut, stabiliser	2.0i, 2.0SE Turbo, 2.0 Turbo, 2.2 TiD, 2.3, 2.3i, 2.3 Turbo	for OE: 350 263	E	'E	'H	CTR5643

9-3 Cabriolet (YS3D)

02/1998 → 08/2003

Tie Rod End	2.0 i, 2.0 SE Turbo, 2.0 Turbo, 2.3, 2.3 i, 2.3 Turbo		E	'E		CTR5427L
Tie Rod End	2.0 i, 2.0 SE Turbo, 2.0 Turbo, 2.3 i, 2.3 Turbo		E		'H	CTR5427R
Rod/Strut, stabiliser	2.0 i, 2.0 SE Turbo, 2.0 Turbo, 2.3, 2.3 i, 2.3 Turbo	for OE: 350 263	E	'E	'H	CTR5643

9-5 (YS3E)

09/1997 → 12/2009

Ball Joint	2.0 Turbo SE, 2.3 Turbo	with add-on material	E	'E	'H	CJ1089
Ball Joint	2.0, 2.0 t, 2.2 TiD, 2.3 t, 2.3 Turbo, 3.0 TiD, 3.0 V6t	→ 06/2002; with add-on material	E	'E	'H	CJ1089
Rod/Strut, stabiliser	1.9 TiD, 2.0, 2.0 t, 2.0 t BioPower, 2.0 Turbo SE, 2.2 TiD, 2.3, 2.3 t, 2.3 t BioPower, 2.3 Turbo, 3.0 TiD, 3.0 V6t	Material: Metal	E	'E	'H	CTR5771

9-5 Estate (YS3E)

10/1998 → 12/2009

Ball Joint	2.0 t, 2.2 TiD, 2.3 t, 2.3 Turbo, 3.0 TiD, 3.0 V6t	→ 06/2002; with add-on material	E	'E	'H	CJ1089
Ball Joint	2.0, 2.3 Turbo	with add-on material	E	'E	'H	CJ1089
Rod/Strut, stabiliser	1.9 TiD, 2.0, 2.0 t, 2.0 t Biopower, 2.2 TiD, 2.3, 2.3 t, 2.3 t BioPower, 2.3 Turbo, 3.0 TiD, 3.0 V6t	Material: Metal	E	'E	'H	CTR5771

				
CJ1089	CTR5427L	CTR5427R	CTR5643	CTR5771
Ref.Nr.: 90542995	Ref.Nr.: 90350447	Ref.Nr.: 0324054	Ref.Nr.: 4400040	Ref.Nr.: 90496116

Article Description			Fitting Position	Article No.
---------------------	---	---	------------------	-------------

FORESTER (SG)

09/2002 → 08/2005

Rod/Strut, stabiliser	2.0, 2.0 S Turbo, 2.0 X, 2.5, 2.5 All-wheel Drive, 2.5 RX Nato AWD, 2.5 XT	for vehicles with stabiliser	Z 'E 'H	CTR0300
-----------------------	--	------------------------------	---------	---------

IMPREZA Hatchback

12/2002 → 09/2005

Rod/Strut, stabiliser	2.0 All-wheel Drive	07/2003 →; Equipment Variant: STI; not for equipment variant: STI PRODRIVE; for vehicles with stabiliser; Manual Transmission, 6-speed; for vehicles with manual transmission	Z 'E 'H	CTR0300
-----------------------	---------------------	---	---------	---------

IMPREZA Saloon (GD)

11/2001 →

Rod/Strut, stabiliser	2.0 WRX STi	07/2003 →; Equipment Variant: STI; not for equipment variant: STI PRODRIVE; for vehicles with stabiliser; Manual Transmission, 6-speed; for vehicles with manual transmission	Z 'E 'H	CTR0300
Rod/Strut, stabiliser	2.5 WRX STi	Equipment Variant: STI, STI-S; not for equipment variant: STI PRODRIVE; for vehicles with stabiliser; Manual Transmission, 6-speed; for vehicles with manual transmission	Z 'E 'H	CTR0300



SUZUKI

Article Description			Fitting Position	Article No.
ALTO (SS80)				06/1982 → 08/1984
Track Control Arm	0.8		E 'E 'H	CJ1084
ALTO Mk II (EC)				01/1986 → 12/1988
Track Control Arm	0.8		E 'E 'H	CJ1084
ALTO Mk III (EF)				09/1994 → 09/1998
Track Control Arm	1.0		E 'E 'H	CJ1084

SUZUKI



CJ1084

Ref.Nr.: 4520069D00

Article Description			Fitting Position	Article No.
---------------------	---	---	------------------	-------------

AURIS (NRE15_, ZZE15_, ADE15_, ZRE15_, NDE15_)

10/2006 → 09/2012

Rod/Strut, stabiliser	1.4 D-4D, 1.4 VVTi, 1.6 VVTi, 2.0 D-4D, 2.2 D		E	'E	'H	CTR6160
Tie Rod Axle Joint	1.33 Dual-VVTi, 1.4D-4D, 1.4VVTi, 1.5, 1.54WD, 1.6, 1.6 VVTi, 1.8, 1.84WD, 1.8 Hybrid, 1.8 VVTi, 2.0D-4D, 2.2D, 2.4 VVTi, 2.4 VVTi 4x4, 3.5 VVTi 4x4		E	'E	'H	RE5957

AVANZA

01/2006 →

Stabilizer Link	1.3 S,SX 1.5 SX, TX			'E	'H	CTR6211
-----------------	---------------------	--	--	----	----	---------

AVENSIS

01/2006 → 12/2008

Track Control Arm	2.0 2.2 2.4		E	'E		CJ266L
Track Control Arm	2.0 2.2 2.4		E		'H	CJ266R
Rod/Strut, stabiliser	2.0 2.2 2.4		E	'E	'H	CTR5916
Tie Rod Axle Joint	2.0 2.2 2.4		E	'E	'H	RE5975

CAMRY

01/1992 → 12/2001

Control Arm-/Trailing Arm Bush	200i SI 220SEI, SI 300SEI		E	'E	'H	BS8424
Tie Rod End	200i SI 220SEI, SI 300SEI		E	'E	'H	CTR5429L

CAMRY

01/2001 → 12/2006

Control Arm-/Trailing Arm Bush	220 GL, GX 2.4 GLI, XLI 3.0 GLX		E	'E	'H	BS8424
Tie Rod End	220 GL, GX 2.4 GLI, XLI 3.0 GLX		E	'E	'H	CTR5429L

CONDOR











01/1998 → 12/2006

Ball Joint	1.8, 2.0I, 2.4I, 3.0		E	'E	'H	CJ281
Tie Rod Axle Joint	1.8, 2.0I, 2.4I, 3.0		E	'E	'H	RE030

CONQUEST

01/1985 → 12/1988

Ball Joint	EE80 1.3 GL, L AE 1.6 GL, RS, RSI		E	'E	'H	CJ935
Tie Rod End	EE80 1.3 GL, L AE 1.6 GL, RS, RSI		E	'E	'H	CTR5343A
Tie Rod Axle Joint	EE80 1.3 GL, L AE 1.6 GL, RS, RSI		E	'E	'H	RE030

						
BS8424	CJ266L	CJ266R	CJ281	CJ935	CTR5343A	CTR5429L
Ref.Nr.: 4865507010	Ref.Nr.: 4806902070	Ref.Nr.: 4806812260	Ref.Nr.: 4333029175	Ref.Nr.: 4333029140	Ref.Nr.: 4504619175	Ref.Nr.: 4504609020
						
CTR5916	CTR6160	CTR6211	RE030	RE5957	RE5975	
Ref.Nr.: 4882047010	Ref.Nr.: 4882042030	Ref.Nr.: 48820B0010	Ref.Nr.: 4550319125	Ref.Nr.: 4550002300	Ref.Nr.: 4550349105	

TOYOTA

Article Description			Fitting Position	Article No.
---------------------	---	---	------------------	-------------

CONQUEST/TAZZ

01/1988 → 12/2006

Ball Joint	EE90 130 SPORT,TAZZ,ZIPP,XE,GS,S,GS,AE92160 RSE, I RS,RSI AE93 180I RSI	1988-1996	E	'E		CJ914
Ball Joint	EE90 130 SPORT,TAZZ,ZIPP,XE,GS,S,GS,AE92160 RSE, I RS,RSI AE93 180I RSI	1988-1996	E		'H	CJ915
Ball Joint	EE90 130 SPORT,TAZZ,ZIPP,XE,GS,S,GS,AE92160 RSE, I RS,RSI AE93 180I RSI	1996-2006	E	'E	'H	CJ949
Tie Rod End	EE90 130 SPORT,TAZZ,ZIPP,XE,GS,S,GS,AE92160 RSE, I RS,RSI AE93 180I RSI		E	'E	'H	CTR5343A
Tie Rod Axle Joint	EE90 130 SPORT,TAZZ,ZIPP,XE,GS,S,GS,AE92160 RSE, I RS,RSI AE93 180I RSI	M/S	E	'E	'H	RE030
Rack End	EE90 130 SPORT,TAZZ,ZIPP,XE,GS,S,GS,AE92160 RSE, I RS,RSI AE93 180I RSI	P/S	E	'E	'H	RE5463

COROLLA

01/1984 → 12/1988

Ball Joint	EE80 1.3 GL,L AE80 GL,AE82 1.6 AVANTE GLE,AVANTE GLI,GLGLE,GLI,SPRINTERGLS,GLX,GLX TWINCAM		E	'E	'H	CJ935
Tie Rod End	EE80 1.3 GL,L AE80 GL,AE82 1.6 AVANTE GLE,AVANTE GLI,GLGLE,GLI,SPRINTERGLS,GLX,GLX TWINCAM		E	'E	'H	CTR5343A
Tie Rod Axle Joint	EE80 1.3 GL,L AE80 GL,AE82 1.6 AVANTE GLE,AVANTE GLI,GLGLE,GLI,SPRINTERGLS,GLX,GLX TWINCAM	M/S	E	'E	'H	RE030

COROLLA

01/1996 → 12/2002

Ball Joint	EE110 130,GLE,AE111 160I GL,GLE,SPRINTER,RSI,RXI,AE112 180I GLE,GSE		E	'E	'H	CJ949	
Tie Rod End	EE110 130,GLE,AE111 160I GL,GLE,SPRINTER,RSI,RXI,AE112 180I GLE,GSE		E	'E	'H	CTR5343A	
Rod/Strut, stabiliser	EE110 130,GLE,AE111 160I GL,GLE,SPRINTER,RSI,RXI,AE112 180I GLE,GSE			Z	'E	'H	CTR5534
Rack End	EE110 130,GLE,AE111 160I GL,GLE,SPRINTER,RSI,RXI,AE112 180I GLE,GSE	P/S	E	'E	'H	RE5463	

COROLLA

01/1988 → 12/1996

Ball Joint	EE90 1.3 GL,GLE,SPRINTER,AE92 160 I GL,GLE,SPRINTER,GLI,GLSAE93180I GSE,GSX,GL,GLE,SPRINTER		E	'E		CJ914	
Ball Joint	EE90 1.3 GL,GLE,SPRINTER,AE92 160 I GL,GLE,SPRINTER,GLI,GLSAE93180I GSE,GSX,GL,GLE,SPRINTER		E		'H	CJ915	
Tie Rod End	EE90 1.3 GL,GLE,SPRINTER,AE92 160 I GL,GLE,SPRINTER,GLI,GLSAE93180I GSE,GSX,GL,GLE,SPRINTER		E	'E	'H	CTR5343A	
Rod/Strut, stabiliser	EE90 1.3 GL,GLE,SPRINTER,AE92 160 I GL,GLE,SPRINTER,GLI,GLSAE93180I GSE,GSX,GL,GLE,SPRINTER			Z	'E	'H	CTR5534
Tie Rod Axle Joint	EE90 1.3 GL,GLE,SPRINTER,AE92 160 I GL,GLE,SPRINTER,GLI,GLSAE93180I GSE,GSX,GL,GLE,SPRINTER	M/S	E	'E	'H	RE030	
Rack End	EE90 1.3 GL,GLE,SPRINTER,AE92 160 I GL,GLE,SPRINTER,GLI,GLSAE93180I GSE,GSX,GL,GLE,SPRINTER	P/S	E	'E	'H	RE5463	

TOYOTA

						
CJ914	CJ915	CJ935	CJ949	CTR5343A	CTR5534	RE030
Ref.Nr.: 4334019015	Ref.Nr.: 4333019066	Ref.Nr.: 4333029140	Ref.Nr.: 4333009640	Ref.Nr.: 4504619175	Ref.Nr.: 4883020010	Ref.Nr.: 4550319125
						
RE5463						
Ref.Nr.: 4550319215						

Article Description			Fitting Position	Article No.
---------------------	---	---	------------------	-------------

COROLLA

01/2002 → 12/2008

Track Control Arm	F11 140I,GLE,GLS,SPRINTER,KS1 160I,GLE,GLS,GLX,GF2 180I GLE,GLS,GSX		E	'E		CJ266L
Track Control Arm	F11 140I,GLE,GLS,SPRINTER,KS1 160I,GLE,GLS,GLX,GF2 180I GLE,GLS,GSX		E		'H	CJ266R
Ball Joint	F11 140I,GLE,GLS,SPRINTER,KS1 160I,GLE,GLS,GLX,GF2 180I GLE,GLS,GSX		E	'E	'H	CJ949
Tie Rod End	F11 140I,GLE,GLS,SPRINTER,KS1 160I,GLE,GLS,GLX,GF2 180I GLE,GLS,GSX		E	'E		CTR5470L
Tie Rod End	F11 140I,GLE,GLS,SPRINTER,KS1 160I,GLE,GLS,GLX,GF2 180I GLE,GLS,GSX		E		'H	CTR5470R
Rod/Strut, stabiliser	F11 140I,GLE,GLS,SPRINTER,KS1 160I,GLE,GLS,GLX,GF2 180I GLE,GLS,GSX		E	'E	'H	CTR5916
Tie Rod Axle Joint	F11 140I,GLE,GLS,SPRINTER,KS1 160I,GLE,GLS,GLX,GF2 180I GLE,GLS,GSX		E	'E	'H	RE2406

COROLLA

01/2008 →

Rod/Strut, stabiliser	1.3 1.6 ADVANCED,IMPACT,PROFESSIONAL 2.0 D4D EXCLUSIVE ADVANCED		E	'E	'H	CTR5916
Rod/Strut, stabiliser	1.3 1.6 ADVANCED,IMPACT,PROFESSIONAL 2.0 D4D EXCLUSIVE ADVANCED		E	'E	'H	CTR6160
Tie Rod Axle Joint	1.3 1.6 ADVANCED,IMPACT,PROFESSIONAL 2.0 D4D EXCLUSIVE ADVANCED	Check Sample	E	'E	'H	RE5957
Tie Rod Axle Joint	1.3 1.6 ADVANCED,IMPACT,PROFESSIONAL 2.0 D4D EXCLUSIVE ADVANCED	Check Sample	E	'E	'H	RE5975

COROLLA Verso (ZDE12_, CDE12_)









09/2001 → 05/2004

Track Control Arm	1.4 D4d, 1.4 VVT-i, 1.6 VVT-i, 1.8 VVT-i, 1.8 VVTi All-wheel Drive, 2.0 D4d, 2.0 D-4D	Material: Sheet Steel; Number of mounting bores: 3; with rubber mounting, without ball joint	E	'E		CJ266L
Track Control Arm	1.4 D4d, 1.4 VVT-i, 1.6 VVT-i, 1.8 VVT-i, 1.8 VVTi All-wheel Drive, 2.0 D4d, 2.0 D-4D	Material: Sheet Steel; Number of mounting bores: 3; with rubber mounting, without ball joint	E		'H	CJ266R
Ball Joint	1.4 D4d, 1.4 VVT-i, 1.6 VVT-i, 1.8 VVT-i, 1.8 VVTi All-wheel Drive, 2.0 D4d, 2.0 D-4D		E	'E	'H	CJ949
Tie Rod End	1.8 VVT-i, 2.0 D-4D		E	'E		CTR5470L
Tie Rod End	1.8 VVT-i, 2.0 D-4D		E		'H	CTR5470R
Rod/Strut, stabiliser	1.4 VVT-i, 1.6 VVT-i, 1.8 VVT-i, 2.0 D-4D	Country Version Japan	E	'E	'H	CTR5916
Tie Rod Axle Joint	1.4 VVT-i, 1.8 VVT-i, 2.0 D-4D		E	'E	'H	RE2406
Tie Rod Axle Joint	1.6 VVT-i	Type: ZZE121R	E	'E	'H	RE2406

COROLLA Verso (ZER_, ZZE12_, R1_)

03/2004 → 03/2009

Track Control Arm	1.4 D-4D, 1.5, 1.6, 1.8, 2.0 D-4D	Material: Sheet Steel; Number of mounting bores: 3; with rubber mounting, without ball joint	E	'E		CJ266L
Track Control Arm	1.4 D-4D, 1.5, 1.6, 1.8, 2.0 D-4D	Material: Sheet Steel; Number of mounting bores: 3; with rubber mounting, without ball joint	E		'H	CJ266R
Ball Joint	1.4 D-4D, 1.5, 1.6, 1.8, 2.0 D-4D		E	'E	'H	CJ949
Rod/Strut, stabiliser	1.6, 1.8, 2.0 D-4D, 2.2 D-4D		E	'E	'H	CTR5916

						
CJ266L	CJ266R	CJ949	CTR5470R	CTR5916	CTR6160	RE2406
Ref.Nr.: 4806902070	Ref.Nr.: 4806812260	Ref.Nr.: 4333009640	Ref.Nr.: 4504649115	Ref.Nr.: 4882047010	Ref.Nr.: 4882042030	Ref.Nr.: 4550312130
						
RE5957	RE5975					
Ref.Nr.: 4550002300	Ref.Nr.: 4550349105					

TOYOTA

Article Description			Fitting Position	Article No.
---------------------	---	---	------------------	-------------

FORTUNER

01/2006 → 12/2015

Ball Joint	3.0 D4D 4.0 V6	Lower	E	'E 'H	CJ1187
Ball Joint	3.0 D4D 4.0 V6	Upper	E	'E 'H	CJ1188
Rod/Strut, stabiliser	3.0 D4D 4.0 V6		E	'E	CTR6014L
Rod/Strut, stabiliser	3.0 D4D 4.0 V6		E	'H	CTR6014R

HI ACE

01/1983 → 12/1992

Ball Joint	YH50/60P/VAN2Y 1.8YH51/613Y 2.0SUPER 10 YH53/63 4 2.2 SUPERT GLX SUPER 14 / 16	Lower Alternative	E	'E 'H	CJ281
Ball Joint	YH50/60P/VAN2Y 1.8YH51/613Y 2.0SUPER 10 YH53/63 4 2.2 SUPERT GLX SUPER 14 / 16	Lower	E	'E 'H	CJ931
Ball Joint	YH50/60P/VAN2Y 1.8YH51/613Y 2.0SUPER 10 YH53/63 4 2.2 SUPERT GLX SUPER 14 / 16	Upper	E	'E 'H	CJ932
Tie Rod End	YH50/60P/VAN2Y 1.8YH51/613Y 2.0SUPER 10 YH53/63 4 2.2 SUPERT GLX SUPER 14 / 16	Outer M17	E	'E 'H	CTR5300
Tie Rod End	YH50/60P/VAN2Y 1.8YH51/613Y 2.0SUPER 10 YH53/63 4 2.2 SUPERT GLX SUPER 14 / 16	Inner M17	E	'E 'H	CTR5317

HI ACE

01/1992 → 12/2008















Ball Joint	YH53/634Y 2.2SUPER 10, SIYAYA, SUPER 14SUPER 16	Lower Alternative	E	'E 'H	CJ281
Ball Joint	YH53/634Y 2.2SUPER 10, SIYAYA, SUPER 14SUPER 16	Lower	E	'E 'H	CJ931
Ball Joint	YH53/634Y 2.2SUPER 10, SIYAYA, SUPER 14SUPER 16	Upper 1993-1995	E	'E 'H	CJ984
Tie Rod End	YH53/634Y 2.2SUPER 10, SIYAYA, SUPER 14SUPER 16	17 mm	E	'E 'H	CTR5005
Tie Rod End	YH53/634Y 2.2SUPER 10, SIYAYA, SUPER 14SUPER 16	15 mm	E	'E 'H	CTR5005A
Tie Rod Axle Joint	YH53/634Y 2.2SUPER 10, SIYAYA, SUPER 14SUPER 16	17 mm	E	'E 'H	RE049
Tie Rod Axle Joint	YH53/634Y 2.2SUPER 10, SIYAYA, SUPER 14SUPER 16	15 mm	E	'E 'H	RE188

HI LUX

01/1974 → 12/1984

Tie Rod End	I2R 1.6 18R 2.0 SR5 2.2	Inner M17	E	'E 'H	CTR5300
Tie Rod End	I2R 1.6 18R 2.0 SR5 2.2	Outer M17	E	'E 'H	CTR5301

TOYOTA

						
CJ1187	CJ281	CJ931	CJ932	CJ984	CTR5005	CTR5005A
Ref.Nr.: 4333009490	Ref.Nr.: 4333029175	Ref.Nr.: 4333029125	Ref.Nr.: 4335029045	Ref.Nr.: 4335029065	Ref.Nr.: 4504669055	Ref.Nr.: 4504629325
						
CTR5300	CTR5301	CTR5317	CTR6014L	CTR6014R	RE049	RE188
Ref.Nr.: 4504639175	Ref.Nr.: 4540629115	Ref.Nr.: 4540629175	Ref.Nr.:	Ref.Nr.:	Ref.Nr.: 4550329255	Ref.Nr.: 4550329565

Article Description			Fitting Position	Article No.
---------------------	---	---	------------------	-------------

HI LUX

01/1984 → 12/1998

Ball Joint	1Y 1.6 2Y 1.8 3Y 2.0 4Y 2.2 SR SRX RAIDER 2.4 22R 2L RAIDER 3L 2.8 P/UP	Upper	E	'E	'H	CJ933
Ball Joint	1Y 1.6 2Y 1.8 3Y 2.0 4Y 2.2 SR SRX RAIDER 2.4 22R 2L RAIDER 3L 2.8 P/UP	Lower	E	'E	'H	CJ934
Tie Rod End	1Y 1.6 2Y 1.8 3Y 2.0 4Y 2.2 SR SRX RAIDER 2.4 22R 2L RAIDER 3L 2.8 P/UP	Inner M17	E	'E	'H	CTR5300
Tie Rod End	1Y 1.6 2Y 1.8 3Y 2.0 4Y 2.2 SR SRX RAIDER 2.4 22R 2L RAIDER 3L 2.8 P/UP	Outer M17	E	'E	'H	CTR5301

HI LUX

01/1998 → 12/2005

Ball Joint	3RZ-FE 2.7 RAIDER LEGEND 35 5L 3.0D KZ-TE RAISED BODY	Upper	E	'E	'H	CJ981
Tie Rod End	2Y 1.8 RAIDER 1RZ 2.0 DLX,S,SR, 2L 2.4 DLX STANDARD BODY	Inner M17	E	'E	'H	CTR5300
Tie Rod End	3RZ-FE 2.7 RAIDER LEGEND 35 5L 3.0D KZ-TE RAISED BODY	Inner M17	E	'E	'H	CTR5300
Tie Rod End	2Y 1.8 RAIDER 1RZ 2.0 DLX,S,SR, 2L 2.4 DLX STANDARD BODY	Outer M17	E	'E	'H	CTR5301

HI LUX

01/2005 →

Ball Joint	1TRFE 2.0 2KD-FTV 2.5TD1D4D 1KD-FTV 3.0D4D 1GR-FE 4.0 V6	Lower	E	'E	'H	CJ1187
Ball Joint	1TRFE 2.0 2KD-FTV 2.5TD1D4D 1KD-FTV 3.0D4D 1GR-FE 4.0 V6	Upper	E	'E	'H	CJ1188
Rod/Strut, stabiliser	1TRFE 2.0 2KD-FTV 2.5TD1D4D 1KD-FTV 3.0D4D 1GR-FE 4.0 V6 HI RIDER		E	'E		CTR6014L
Rod/Strut, stabiliser	1TRFE 2.0 2KD-FTV 2.5TD1D4D 1KD-FTV 3.0D4D 1GR-FE 4.0 V6 HI RIDER		E		'H	CTR6014R
Stabilizer Link	1TRFE 2.0 2KD-FTV 2.5TD1D4D 1KD-FTV 3.0D4D 1GR-FE 4.0 V6 STANDERD BODY			'E	'H	CTR6115

LAND CRUISER (LJ12_, KZJ12_, TRJ12_, KDJ12_, GRJ12_)

09/2002 → 07/2009

Rod/Strut, stabiliser	2.7 , 3.0 D, 3.0 D-4D , 3.4, 4.0		E	'E		CTR6014L
Rod/Strut, stabiliser	2.7 , 3.0 D, 3.0 D-4D , 3.4, 4.0		E		'H	CTR6014R

LAND CRUISER 150 (KDJ15_, GRJ15_)

01/2010 →

Rod/Strut, stabiliser	2.7 4WD, 3.0D-4D, 4.0V6 Dual VVTi, 4.0V6 VVTi, 4.0V6 VVT-i		E	'E		CTR6014L
Rod/Strut, stabiliser	2.7 4WD, 3.0D-4D, 4.0V6 Dual VVTi, 4.0V6 VVTi, 4.0V6 VVT-i		E		'H	CTR6014R

MR2

01/2001 → 12/2004

Tie Rod Axle Joint	1.8I		E	'E	'H	RE2406
--------------------	------	--	---	----	----	--------

PREVIA (MCR3_, ACR3_, CLR3_)

03/2001 → 01/2006

Tie Rod Axle Joint	2.0 D-4D	03/2003 →	E	'E	'H	RE5975
--------------------	----------	-----------	---	----	----	--------

PRIUS Saloon (NHW11_)

05/2000 → 01/2004

Ball Joint	1.5		E	'E	'H	CJ949
Tie Rod End	1.5		E	'E		CTR5470L
Tie Rod End	1.5		E		'H	CTR5470R
Rod/Strut, stabiliser	1.5	Country Version Japan	E	'E	'H	CTR5916

						
CJ1187	CJ933	CJ934	CJ949	CJ981	CTR5300	CTR5301
Ref.Nr.: 4333009490	Ref.Nr.: 4335039035	Ref.Nr.: 4333039165	Ref.Nr.: 4333009640	Ref.Nr.: 4335039045	Ref.Nr.: 4504639175	Ref.Nr.: 4540629115
						
CTR5470R	CTR5916	CTR6014L	CTR6014R	CTR6115	RE2406	RE5975
Ref.Nr.: 4504649115	Ref.Nr.: 4882047010	Ref.Nr.:	Ref.Nr.:	Ref.Nr.: 488200K010	Ref.Nr.: 4550312130	Ref.Nr.: 4550349105

TOYOTA

Article Description			Fitting Position	Article No.
---------------------	---	---	------------------	-------------

PRIUS Hatchback (NHW20_)

08/2003 → 03/2009

Rod/Strut, stabiliser	1.5		E	'E 'H	CTR5916
-----------------------	-----	--	---	-------	---------

QUANTUM

01/2005 →

Track Control Arm	2.5D BUS P/VAN 2.7I	Upper LHS	E	'E	CJ1168L
Track Control Arm	2.5D BUS P/VAN 2.7I	Upper RHS	E	'H	CJ1168R
Ball Joint	2.5D BUS P/VAN 2.7I	Lower	E	'E 'H	CJ1169
Track Control Arm	2.5D BUS P/VAN 2.7I	Lower LHS	E	'E	CJ1170L
Track Control Arm	2.5D BUS P/VAN 2.7I	Lower RHS	E	'H	CJ1170R
Tie Rod End	2.5D BUS P/VAN 2.7I		E	'E 'H	CTR5812
Tie Rod Axle Joint	2.5D BUS P/VAN 2.7I	15 mm	E	'E 'H	RE188

RAV4 I

01/1994 → 12/2002

Tie Rod End	1.8 SXA10 SUV 2.0 SXA11 SUV		E	'E 'H	CTR5343A
Rack End	1.8 SXA10 SUV 2.0 SXA11 SUV		E	'E 'H	RE5463

RAV4 II

01/2003 → 12/2006

Ball Joint	180,200 SUV		E	'E 'H	CJ949
------------	-------------	--	---	-------	-------

RUNX

01/2003 → 12/2008

Track Control Arm	140I R,RT,160I RS,RT,RX,180I RSI,2.0 RSI		E	'E	CJ266L
Track Control Arm	140I R,RT,160I RS,RT,RX,180I RSI,2.0 RSI		E	'H	CJ266R
Ball Joint	140I R,RT,160I RS,RT,RX,180I RSI,2.0 RSI		E	'E 'H	CJ949
Tie Rod End	140I R,RT,160I RS,RT,RX,180I RSI,2.0 RSI		E	'E	CTR5470L
Tie Rod End	140I R,RT,160I RS,RT,RX,180I RSI,2.0 RSI		E	'H	CTR5470R
Rod/Strut, stabiliser	140I R,RT,160I RS,RT,RX,180I RSI,2.0 RSI		E	'E 'H	CTR5916
Tie Rod Axle Joint	140I R,RT,160I RS,RT,RX,180I RSI,2.0 RSI		E	'E 'H	RE2406

YARIS

01/2005 →

Tie Rod End	1.0 T 1.3 T3		E	'E	CTR5470L
Tie Rod End	1.0 T 1.3 T3		E	'H	CTR5470R
Tie Rod Axle Joint	1.0 T 1.3 T3		E	'E 'H	RE2406

TOYOTA

						
CJ266L	CJ266R	CJ949	CTR5343A	CTR5470R	CTR5812	CTR5916
Ref.Nr.: 4806902070	Ref.Nr.: 4806812260	Ref.Nr.: 4333009640	Ref.Nr.: 4504619175	Ref.Nr.: 4504649115	Ref.Nr.: 4504629456	Ref.Nr.: 4882047010
						
RE188	RE2406	RE5463				
Ref.Nr.: 4550329565	Ref.Nr.: 4550312130	Ref.Nr.: 4550319215				

Article Description			Fitting Position	Article No.
---------------------	---	---	------------------	-------------

C30 10/2006 → 12/2012

Tie Rod End	1.6, 1.6 D, 1.8, 2.0, 2.0 D, 2.4 i, D5, T5		E	'E		CTR5921L
Tie Rod End	1.6, 1.6 D, 1.8, 2.0, 2.0 D, 2.4 i, D5, T5		E		'H	CTR5921R

C70 II Convertible 03/2006 → 06/2013

Tie Rod End	2.4, 2.4 i, D5, T5		E	'E		CTR5921L
Tie Rod End	2.4, 2.4 i, D5, T5		E		'H	CTR5921R
Rod/Strut, stabiliser	2.4, 2.4 i, D5, T5			Z	'E 'H	CTR6191

S40 I (VS) 07/1995 → 12/2003

Rod/Strut, stabiliser	1.6, 1.8, 1.8 i, 1.9 DI, 2.0, 2.0 T, 2.0 T4	01/2001 →	E	'E	'H	CTR6015
Rod/Strut, stabiliser	1.8 i, 2.0 T		E	'E	'H	CTR6015

S40 II (MS) 01/2004 → 12/2012

Ball Joint	1.6, 1.6 D, 1.8, 2.0 D, 2.4, T5, T5 AWD	ch.197553→; Vehicle Production Country The Netherlands	E	'E	'H	CJ1259
Ball Joint	1.6, 1.6 D, 1.8, 2.0 D, 2.4, T5, T5 AWD	ch.209291→; Vehicle Production Country Belgium	E	'E	'H	CJ1259
Tie Rod End	1.6, 1.6 D, 1.8, 2.0 D, 2.4, T5, T5 AWD		E	'E		CTR5921L
Tie Rod End	1.6, 1.6 D, 1.8, 2.0 D, 2.4, T5, T5 AWD		E		'H	CTR5921R
Rod/Strut, stabiliser	1.6, 1.6 D, 1.8, 2.0 D, 2.4, T5, T5 AWD		E			CTR5923
Rod/Strut, stabiliser	1.6 D, 1.8, 2.0, 2.0 D, 2.4, 2.4 D5, T5, T5 AWD			Z	'E 'H	CTR6191

S60 I 07/2000 → 04/2010

Rod/Strut, stabiliser	2.0T, 2.3T5, 2.4, 2.4 Bifuel, 2.4D, 2.4D5, 2.4T, 2.4TAWD, 2.4 T5, 2.5 T, 2.5 T AWD, R 2.5 T AWD, T5		E	'E	'H	CTR5774
-----------------------	---	--	---	----	----	---------

S80 I (TS, XY) 05/1998 → 07/2006

Rod/Strut, stabiliser	2.0, 2.0T, 2.4, 2.4 Bifuel, 2.4D, 2.4D5, 2.4T, 2.5T AWD, 2.5 TDI, 2.8 T6, 2.9, 3.0, 3.0 T6		E	'E	'H	CTR5774
-----------------------	--	--	---	----	----	---------

V40 Estate (VW) 07/1995 → 06/2004

Rod/Strut, stabiliser	1.6, 1.8, 1.8 i, 1.9 DI, 2.0, 2.0 T, 2.0 T4	01/2001 →	E	'E	'H	CTR6015
Rod/Strut, stabiliser	1.8 i, 2.0 T		E	'E	'H	CTR6015

V50 (MW) 04/2004 → 12/2012

Ball Joint	1.6, 1.6 D, 1.8, 2.0 D, 2.4, T5, T5 AWD	ch.214683→	E	'E	'H	CJ1259
Tie Rod End	1.6, 1.6 D, 1.8, 2.0 D, 2.4, T5, T5 AWD		E	'E		CTR5921L
Tie Rod End	1.6, 1.6 D, 1.8, 2.0 D, 2.4, T5, T5 AWD		E		'H	CTR5921R
Rod/Strut, stabiliser	1.6, 1.6 D, 1.8, 2.0 D, 2.4, T5, T5 AWD		E			CTR5923
Rod/Strut, stabiliser	1.6 D, 1.8, 2.0, 2.0 D, 2.4, 2.4 D5, T5, T5 AWD			Z	'E 'H	CTR6191

V70 (LV) 03/1999 → 03/2000



Rod/Strut, stabiliser	2.5 AWD		E	'E	'H	CTR5774
-----------------------	---------	--	---	----	----	---------

V70 Mk II (SW) 03/2000 → 08/2007

Rod/Strut, stabiliser	2.0T, 2.3T5, 2.4, 2.4 Bifuel, 2.4D, 2.4D5, 2.4D5 AWD, 2.4 T, 2.4TAWD, 2.4T5, 2.5 R Sport, 2.5T, 2.5T AWD, 2.5 TDI, R 2.5 T AWD		E	'E	'H	CTR5774
-----------------------	--	--	---	----	----	---------

					
CJ1259	CTR5774	CTR5921R	CTR5923	CTR6015	CTR6191
Ref.Nr.: 1679388	Ref.Nr.: 8634736	Ref.Nr.: 1317446	Ref.Nr.: 3M513B438AB	Ref.Nr.: 30884179	Ref.Nr.: 1310333

VOLVO

Article Description			Fitting Position	Article No.
XC70 CROSS COUNTRY			03/2000 → 08/2007	
Rod/Strut, stabiliser	2.4 D5 AWD, 2.4 D5 XC AWD, 2.4 T XC AWD, 2.5 T XC AWD		E	'E 'H CTR5774
XC90 I			10/2002 → 12/2010	
Rod/Strut, stabiliser	2.5 T, D5, T6, V8		E	'E 'H CTR5774

VOLVO

	
CTR5774	
Ref.Nr.: 8634736	

Article Description			Fitting Position	Article No.
---------------------	---	---	------------------	-------------

AMAROK (2H_, S1B)

09/2010 →

Control Arm-/Trailing Arm Bush	2.0BiTDI, 2.0BiTDI 4motion, 2.0 TDI, 2.0 TDI 4motion, 2.0 TS	Rubber-metal Bearing	E	'E	'H	BS8272
--------------------------------	--	----------------------	---	----	----	--------

NEW BEETLE Convertible (1Y7)

09/2002 → 10/2010

Repair Kit, ball joint	1.4, 1.6, 1.8 T, 1.9 TDI, 2.0		E	'E		CJ986
Repair Kit, ball joint	1.4, 1.6, 1.8 T, 1.9 TDI, 2.0		E		'H	CJ987
Tie Rod End	1.4, 1.6, 1.8 T, 1.9 TDI, 2.0, 2.5		E	'E		CTR5706L
Tie Rod End	1.4, 1.6, 1.8 T, 1.9 TDI, 2.0, 2.5		E		'H	CTR5706R
Top Strut Mounting	1.4, 1.6, 1.8 T, 1.9 TDI, 2.0, 2.5	without ball bearing	E	'E	'H	MO6180
Tie Rod Axle Joint	1.4, 1.6, 1.8 T, 1.9 TDI, 2.0, 2.5		E	'E	'H	RE8143

NEW BEETLE (9C1, 1C1)

01/1998 → 09/2010

Control Arm-/Trailing Arm Bush	1.4, 1.6, 1.8 T, 1.9 TDI, 2.0, 2.3 V5, RSI 3.2 4motion		E	'E	'H	BS6417
Control Arm-/Trailing Arm Bush	1.4, 1.6, 1.8 T, 1.9 TDI, 2.0, 2.3 V5, RSI 3.2 4motion		E	'E	'H	BS6911
Repair Kit, ball joint	1.4, 1.6, 1.8 T, 1.9 TDI, 2.0, 2.3 V5		E	'E		CJ986
Repair Kit, ball joint	1.4, 1.6, 1.8 T, 1.9 TDI, 2.0, 2.3 V5		E		'H	CJ987
Tie Rod End	1.4, 1.6, 1.8 T, 1.9 TDI, 2.0, 2.3 V5, 2.5	ch.1J-W-047125→	E	'E		CTR5706L
Tie Rod End	1.4, 1.6, 1.8 T, 1.9 TDI, 2.0, 2.3 V5, 2.5	ch.1J-W-047125→	E		'H	CTR5706R
Top Strut Mounting	1.4, 1.6, 1.8 T, 1.9 TDI, 2.0, 2.3 V5, 2.5, RSI 3.2 4motion	without ball bearing	E	'E	'H	MO6180
Tie Rod Axle Joint	1.4, 1.6, 1.8 T, 1.9 TDI, 2.3 V5, 2.5		E	'E	'H	RE8143
Tie Rod Axle Joint	1.9 TDI, 2.0	ch.1J-W-047125→	E	'E	'H	RE8143

BEETLE (5C1)

04/2011 →

Control Arm-/Trailing Arm Bush	1.2 TSI, 1.4 TSI, 1.6 TDI, 2.0 TDI, 2.0 TSI	Rubber-metal Bearing	E	'E	'H	BS6899
Rod/Strut, stabiliser	1.2 TSI, 1.4 TSI, 1.6 TDI, 2.0 TDI, 2.0 TSI	Material: Steel	E	'E	'H	CTR5849

CADDY Mk I / Mk II

01/1982 → 12/2003

Track Control Arm	1.3.1.4. 1.5.1.6.1.8		E	'E	'H	CJ108
Ball Joint	1.3.1.4. 1.5.1.6.1.8	17 mm	E	'E	'H	CJ832
Tie Rod End	1.3.1.4. 1.5.1.6.1.8		E	'E	'H	CTR5140

						
BS6417	BS6899	BS6911	BS8272	CJ108	CJ832	CJ986
Ref.Nr.: 1J0407181	Ref.Nr.: 1K0407182	Ref.Nr.: 191407182	Ref.Nr.: 2H0407183A	Ref.Nr.: 171407153D	Ref.Nr.: 171407365F	Ref.Nr.: 1J0407365A
						
CJ987	CTR5140	CTR5706L	CTR5706R	CTR5849	MO6180	RE8143
Ref.Nr.: 1J0407366H	Ref.Nr.: 32111116463	Ref.Nr.: 1J0422811B	Ref.Nr.: 1J0422812B	Ref.Nr.: 1K0411315G	Ref.Nr.: 1J0412331B	Ref.Nr.: 1J0422807B

Article Description			Fitting Position	Article No.
---------------------	---	---	------------------	-------------

CADDY Mk I / Mk II

01/1982 → 12/2003

Tie Rod Axle Joint	1.3.1.4, 1.5.1.6.1.8		E	'E 'H	RE033
--------------------	----------------------	--	---	-------	-------

CADDY Mk III Box (2KA, 2KH, 2CA, 2CH)

03/2004 → 08/2010

Control Arm-/Trailing Arm Bush	1.4, 1.4 16V, 1.6, 1.9 TDI, 2.0 EcoFuel, 2.0 SDI, 2.0 TDI	Material: Aluminium	E	'E	BS6883
Control Arm-/Trailing Arm Bush	1.4, 1.4 16V, 1.6, 1.9 TDI, 2.0 EcoFuel, 2.0 SDI, 2.0 TDI	Material: Aluminium	E	'H	BS6884
Control Arm-/Trailing Arm Bush	1.2 TSI, 1.4, 1.4 16V, 1.6, 1.6 BiFuel, 1.6 TDI, 1.9 TDI, 1.9 TDI 4motion, 2.0 EcoFuel, 2.0 SDI, 2.0 TDI, 2.0 TDI 16V, 2.0 TDI 16V 4motion, 2.0 TDI 4motion	Rubber-metal Bearing	E	'E 'H	BS6899
Rod/Strut, stabiliser	1.2 TSI, 1.4, 1.4 16V, 1.6, 1.6 BiFuel, 1.6 TDI, 1.9 TDI, 1.9 TDI 4motion, 2.0 EcoFuel, 2.0 SDI, 2.0 TDI, 2.0 TDI 16V, 2.0 TDI 16V 4motion, 2.0 TDI 4motion	Material: Steel	E	'E 'H	CTR5849
Tie Rod Axle Joint	1.2 TSI, 1.4, 1.4 16V, 1.6, 1.6 BiFuel, 1.6 TDI, 1.9 TDI, 1.9 TDI 4motion, 2.0 SDI, 2.0 TDI, 2.0 EcoFuel, 2.0 TDI, 2.0 TDI 16V, 2.0 TDI 16V 4motion, 2.0 TDI 4motion		E	'E 'H	RE5841

CADDY Mk III Estate (2KB, 2KJ, 2CB, 2CJ)

03/2004 → 08/2010

Control Arm-/Trailing Arm Bush	1.4, 1.4 16V, 1.6, 1.9 TDI, 1.9 TDI 4motion, 2.0 EcoFuel, 2.0 SDI, 2.0 TDI	Material: Aluminium	E	'E	BS6883
Control Arm-/Trailing Arm Bush	1.4, 1.4 16V, 1.6, 1.9 TDI, 1.9 TDI 4motion, 2.0 EcoFuel, 2.0 SDI, 2.0 TDI	Material: Aluminium	E	'H	BS6884
Control Arm-/Trailing Arm Bush	1.2 TSI, 1.4, 1.4 16V, 1.6, 1.6 BiFuel, 1.6 TDI, 1.9 TDI, 1.9 TDI 4motion, 2.0 EcoFuel, 2.0 SDI, 2.0 TDI, 2.0 TDI 16V, 2.0 TDI 16V 4motion, 2.0 TDI 4motion	Rubber-metal Bearing	E	'E 'H	BS6899
Rod/Strut, stabiliser	1.2 TSI, 1.4, 1.4 16V, 1.6, 1.6 BiFuel, 1.6 TDI, 1.9 TDI, 1.9 TDI 4motion, 2.0 EcoFuel, 2.0 SDI, 2.0 TDI, 2.0 TDI 16V, 2.0 TDI 16V 4motion, 2.0 TDI 4motion	Material: Steel	E	'E 'H	CTR5849
Tie Rod Axle Joint	1.2 TSI, 1.4, 1.4 16V, 1.6, 1.6 BiFuel, 1.6 TDI, 1.9 TDI, 1.9 TDI 4motion, 2.0 SDI, 2.0 TDI, 2.0 EcoFuel, 2.0 TDI, 2.0 TDI 16V, 2.0 TDI 4motion, 2.0 TDI 16V 4motion	for steering gear manufacturer: ZF; for vehicles with electric power steering	E	'E 'H	RE5841

CC (358)











11/2011 →

Control Arm-/Trailing Arm Bush	1.4 TSI, 1.8 TSI, 2.0 TDI, 2.0 TDI 4motion, 2.0 TSI, 3.6 FSI 4motion	Rubber-metal Bearing	E	'E 'H	BS6899
Rod/Strut, stabiliser	1.8 TSI, 2.0 TDI, 2.0 TSI, 3.6 FSI 4motion	Material: Steel	E	'E 'H	CTR5849
Tie Rod Axle Joint	1.8 TSI, 2.0 TDI, 2.0 TSI, 3.6 FSI 4motion	for vehicles with electric power steering	E	'E 'H	RE5841

CORRADO (53I)

09/1988 → 12/1995

Control Arm-/Trailing Arm Bush	1.8 16V, 1.8 G60, 2.0 i, 2.0 i 16V, 2.9 VR6		E	'E 'H	BS6911
Ball Joint	2.9 VR6		E	'E 'H	CJ1031
Ball Joint	1.8 16V, 1.8 G60, 2.0 i, 2.0 i 16V, 2.9 VR6	with fastening material; with accessories	E	'E 'H	CJ864
Tie Rod End	1.8 16V, 1.8 G60, 2.0 i, 2.0 i 16V, 2.9 VR6		E	'E	CTR5191L
Tie Rod End	1.8 16V, 1.8 G60, 2.0 i, 2.0 i 16V, 2.9 VR6		E	'H	CTR5191R
Repair Kit, link	1.8 16V, 1.8 G60, 2.0 i, 2.0 i 16V, 2.9 VR6	with guide sleeve	E	'E 'H	MO5414
Tie Rod Axle Joint	1.8 16V, 1.8 G60, 2.0 i, 2.0 i 16V, 2.9 VR6	for vehicles without power steering	E	'E 'H	RE5192
Tie Rod Axle Joint	1.8 16V, 1.8 G60, 2.0 i, 2.0 i 16V	for vehicles with power steering	E	'E 'H	RE5473

						
BS6883	BS6884	BS6899	BS6911	CJ1031	CJ864	CTR5191L
Ref.Nr.: 1K0199231J	Ref.Nr.: 1K0199232J	Ref.Nr.: 1K0407182	Ref.Nr.: 191407182	Ref.Nr.: 1H0407365	Ref.Nr.: 357407365	Ref.Nr.: 3A0422811
						
CTR5191R	CTR5849	MO5414	RE033	RE5192	RE5473	RE5841
Ref.Nr.: 191419812	Ref.Nr.: 1K0411315G	Ref.Nr.: 191407181D	Ref.Nr.: 171419821	Ref.Nr.: 191419804PAR	Ref.Nr.: 191422804APA	Ref.Nr.: 1K0423810A

Article Description			Fitting Position	Article No.
---------------------	--	--	------------------	-------------

CRAFTER 30-35 Bus (2E_)

04/2006 → 07/2011

Tie Rod End	2.0 TDI, 2.0 TDI 4motion, 2.5 TDI		E	'E	'H	CTR5927
Tie Rod Axle Joint	2.0 TDI, 2.0 TDI 4motion, 2.5 TDI		E	'E	'H	RE5928

CRAFTER 30-50 Box (2E_)

04/2006 → 07/2011

Tie Rod End	2.0 TDI, 2.0 TDI 4motion, 2.5 TDI		E	'E	'H	CTR5927
Tie Rod Axle Joint	2.0 TDI, 2.0 TDI 4motion, 2.5 TDI		E	'E	'H	RE5928

CRAFTER 30-50 Platform/Chassis (2F_)

04/2006 → 07/2011

Tie Rod End	2.0 TDI, 2.0 TDI 4motion, 2.5 TDI		E	'E	'H	CTR5927
Tie Rod Axle Joint	2.0 TDI, 2.0 TDI 4motion, 2.5 TDI		E	'E	'H	RE5928

EOS (1F7, 1F8)

03/2006 → 08/2015

Control Arm-/Trailing Arm Bush	1.4 TSI, 1.6 FSI, 2.0 FSI, 2.0 TDI, 2.0 TFSI, 2.0 TSI, 3.2 V6, 3.6 V6	Material: Aluminium	E	'E		BS6883
Control Arm-/Trailing Arm Bush	1.4 TSI, 1.6 FSI, 2.0 FSI, 2.0 TDI, 2.0 TFSI, 2.0 TSI, 3.2 V6, 3.6 V6	Material: Aluminium	E		'H	BS6884
Control Arm-/Trailing Arm Bush	1.4 TSI, 1.6 FSI, 2.0 FSI, 2.0 TDI, 2.0 TDI 16V, 2.0 TFSI, 2.0 TSI, 3.2 V6, 3.6 V6	Rubber-metal Bearing	E	'E	'H	BS6899
Rod/Strut, stabiliser	1.4 TSI, 1.6 FSI, 2.0 FSI, 2.0 TDI, 2.0 TDI 16V, 2.0 TFSI, 2.0 TSI, 3.2 V6, 3.6 V6	Material: Steel	E	'E	'H	CTR5849
Tie Rod Axle Joint	1.4 TSI, 1.6 FSI, 2.0 FSI, 2.0 TDI, 2.0 TDI 16V, 2.0 TFSI, 3.2 V6, 3.6 V6		E	'E	'H	RE5841

FOX

01/1987 → 12/1995

Track Control Arm	1.3.1.4. 1.5.1.6.1.8		E	'E	'H	CJ108
Ball Joint	1.3.1.4. 1.5.1.6.1.8	17 mm	E	'E	'H	CJ832
Tie Rod End	1.3.1.4. 1.5.1.6.1.8		E	'E	'H	CTR5140
Tie Rod Axle Joint	1.3.1.4. 1.5.1.6.1.8		E	'E	'H	RE033

GOLF 1/CITI/VELOCITY

01/1979 → 12/2010

Track Control Arm	1.3.1.4. 1.5.1.6.1.8		E	'E	'H	CJ108
Ball Joint	1.3.1.4. 1.5.1.6.1.8	17 mm	E	'E	'H	CJ832
Tie Rod End	1.3.1.4. 1.5.1.6.1.8		E	'E	'H	CTR5140
Tie Rod Axle Joint	1.3.1.4. 1.5.1.6.1.8		E	'E	'H	RE033

GOLF Convertible (155)

01/1979 → 04/1993

Track Control Arm	1.5, 1.6, 1.8	with rubber mounting, without ball joint	E	'E	'H	CJ108
Ball Joint	1.5, 1.6, 1.8		E	'E	'H	CJ832
Tie Rod End	1.5, 1.6, 1.8		E	'E	'H	CTR5140
Tie Rod Axle Joint	1.5, 1.6, 1.8		E	'E	'H	RE033

BS6883	BS6884	BS6899	CJ108	CJ832	CTR5140	CTR5849
Ref.Nr.: 1K0199231J	Ref.Nr.: 1K0199232J	Ref.Nr.: 1K0407182	Ref.Nr.: 171407153D	Ref.Nr.: 171407365F	Ref.Nr.: 32111116463	Ref.Nr.: 1K0411315G
CTR5927	RE033	RE5841	RE5928			
Ref.Nr.: 90610481003	Ref.Nr.: 171419821	Ref.Nr.: 1K0423810A	Ref.Nr.: 90610551003			

Article Description			Fitting Position	Article No.
---------------------	---	---	------------------	-------------

GOLF Mk II (19E, 1G1)













08/1983 → 12/1992

Control Arm-/Trailing Arm Bush	1.0, 1.3, 1.3CAT, 1.6, 1.6D, 1.6TD, 1.8, 1.8GTI, 1.8GTI 16V, 1.8 GTI CAT, 1.8 GTI G60, 1.8 GTI G60 Syncro, 1.8 i CAT, 1.8 i Syncro CAT, 1.8 Syncro		E	E	H	BS6911
Ball Joint	1.0, 1.3, 1.3CAT, 1.6, 1.6D, 1.6TD, 1.8, 1.8GTI, 1.8GTI 16V, 1.8 GTI CAT, 1.8 GTI G60, 1.8 GTI G60 Syncro, 1.8 i CAT, 1.8 i Syncro CAT, 1.8 Syncro	with fastening material; with accessories, 19 mm	E	E	H	CJ864
Ball Joint	1.0, 1.3, 1.3CAT, 1.6, 1.6D, 1.6TD, 1.8, 1.8GTI, 1.8GTI 16V, 1.8 GTI CAT, 1.8 Syncro	with accessories, 17 mm	E	E	H	CJ957
Tie Rod End	1.0, 1.3, 1.3CAT, 1.6, 1.6D, 1.6TD, 1.8, 1.8GTI, 1.8GTI 16V, 1.8 GTI CAT, 1.8 GTI G60, 1.8 GTI G60 Syncro, 1.8 i CAT, 1.8 i Syncro CAT, 1.8 Syncro		E	E		CTR5191L
Tie Rod End	1.0, 1.3, 1.3CAT, 1.6, 1.6D, 1.6TD, 1.8, 1.8GTI, 1.8GTI 16V, 1.8 GTI CAT, 1.8 GTI G60, 1.8 GTI G60 Syncro, 1.8 i CAT, 1.8 i Syncro CAT, 1.8 Syncro		E		H	CTR5191R
Repair Kit, link	1.0, 1.3, 1.3CAT, 1.6, 1.6D, 1.6TD, 1.8, 1.8GTI, 1.8GTI 16V, 1.8 GTI CAT, 1.8 GTI G60, 1.8 GTI G60 Syncro, 1.8 i CAT, 1.8 i Syncro CAT, 1.8 Syncro	with guide sleeve	E	E	H	MO5414
Tie Rod Axle Joint	1.0, 1.3, 1.3CAT, 1.6, 1.6D, 1.6TD, 1.8, 1.8GTI, 1.8GTI 16V, 1.8 GTI CAT, 1.8 GTI G60, 1.8 GTI G60 Syncro, 1.8 i CAT, 1.8 i Syncro CAT, 1.8 Syncro	for vehicles without power steering	E	E	H	RE5192
Tie Rod Axle Joint	1.0, 1.3, 1.3CAT, 1.6, 1.6D, 1.6TD, 1.8, 1.8GTI, 1.8GTI 16V, 1.8 GTI CAT, 1.8 GTI G60, 1.8 i CAT, 1.8 i Syncro CAT, 1.8 Syncro	for vehicles with power steering	E	E	H	RE5473

GOLF Mk III

01/1992 → 12/1999

Control Arm-/Trailing Arm Bush	1.6 CSL, 1.8 CLX, CSX, 2.0 CLI 2.8 2.9 VR6	Control Arm Bush Rear ID13/OD60/L41	E	E	H	BS6417
Ball Joint	2.0 2.8 VR6 2.9 VR6	16,5 mm	E	E	H	CJ1031
Track Control Arm	1.6 CSL, 1.8 CLX, CSX, 2.0 CLI	Exc VR6	E	E	H	CJ111L
Ball Joint	1.6 CSL, 1.8 CLX, CSX, 2.0 CLI	19 mm Exc VR6	E	E	H	CJ864
Tie Rod End	1.6 CSL, 1.8 CLX, CSX, 2.0 CLI 2.8 2.9 VR6		E	E		CTR5191L
Tie Rod End	1.6 CSL, 1.8 CLX, CSX, 2.0 CLI 2.8 2.9 VR6		E		H	CTR5191R
Repair Kit, link	1.6 CSL, 1.8 CLX, CSX, 2.0 CLI 2.8 2.9 VR6	Control Arm Bush Rear ID17/OD60/L41	E	E	H	MO5414
Top Strut Mounting	1.6 CSL, 1.8 CLX, CSX, 2.0 CLI 2.8 2.9 VR6	Shock Mounting Front	E	E	H	MO6180
Rack End	1.6 CSL, 1.8 CLX, CSX, 2.0 CLI 2.8 2.9 VR6	P/S	E	E	H	RE5438

						
BS6417	BS6911	CJ1031	CJ111L	CJ864	CJ957	CTR5191L
Ref.Nr.: 1J0407181	Ref.Nr.: 191407182	Ref.Nr.: 1H0407365	Ref.Nr.: 1H0407151	Ref.Nr.: 357407365	Ref.Nr.: 191407365	Ref.Nr.: 3A0422811
						
CTR5191R	MO5414	MO6180	RE5192	RE5438	RE5473	
Ref.Nr.: 191419812	Ref.Nr.: 191407181D	Ref.Nr.: 1J0412331B	Ref.Nr.: 191419804PAR	Ref.Nr.:	Ref.Nr.: 191422804APA	

Article Description			Fitting Position	Article No.
---------------------	--	--	------------------	-------------

GOLF Mk IV

01/1999 → 12/2004

Control Arm-/Trailing Arm Bush	1.6I,1.8 GTI,1.9TDI,STD,COMFORTLINE,HIGHLINE	Control Arm Bush Rear ID13/OD60/L41	E	'E	'H	BS6417
Repair Kit, ball joint	1.6I,1.8 GTI,1.9TDI,STD,COMFORTLINE,HIGHLINE		E	'E		CJ986
Repair Kit, ball joint	1.6I,1.8 GTI,1.9TDI,STD,COMFORTLINE,HIGHLINE		E		'H	CJ987
Tie Rod End	1.6I,1.8 GTI,1.9TDI,STD,COMFORTLINE,HIGHLINE		E	'E		CTR5706L
Tie Rod End	1.6I,1.8 GTI,1.9TDI,STD,COMFORTLINE,HIGHLINE		E		'H	CTR5706R
Repair Kit, link	1.6I,1.8 GTI,1.9TDI,STD,COMFORTLINE,HIGHLINE	Control Arm Bush Rear ID17/OD60/L41	E	'E	'H	MO5414
Top Strut Mounting	1.6I,1.8 GTI,1.9TDI,STD,COMFORTLINE,HIGHLINE	Shock Mounting Front	E	'E	'H	MO6180
Tie Rod Axle Joint	1.6I,1.8 GTI,1.9TDI,STD,COMFORTLINE,HIGHLINE		E	'E	'H	RE8143

GOLF Mk V (1K1, 1K5)

10/2003 → 02/2009

Control Arm-/Trailing Arm Bush	1.4 16V, 1.4 FSI, 1.4 TSI, 1.6, 1.6 FSI, 1.9 TDI, 1.9 TDI 4motion, 2.0, 2.0 FSI, 2.0 FSI 4motion, 2.0 GTI, 2.0 SDI, 2.0 TDI, 2.0 TDI 16V, 2.0 TDI 16V 4motion, 2.0 TDI 4motion, 3.2, 3.2 R32 4motion	Material: Aluminium	E	'E		BS6883
Control Arm-/Trailing Arm Bush	1.4 16V, 1.4 FSI, 1.4 TSI, 1.6, 1.6 FSI, 1.9 TDI, 1.9 TDI 4motion, 2.0, 2.0 FSI, 2.0 FSI 4motion, 2.0 GTI, 2.0 SDI, 2.0 TDI, 2.0 TDI 16V, 2.0 TDI 16V 4motion, 2.0 TDI 4motion, 3.2, 3.2 R32 4motion	Material: Aluminium	E		'H	BS6884
Control Arm-/Trailing Arm Bush	1.4 16V, 1.4 FSI, 1.4 TSI, 1.6, 1.6 FSI, 1.6 MultiFuel, 1.8, 1.8 GTI, 1.8 Hybrid, 1.9 SDI, 1.9 TDI, 1.9 TDI 4motion, 2.0, 2.0 FSI, 2.0 FSI 4motion, 2.0 GTI, 2.0 SDI, 2.0 TDI, 2.0 TDI 16V, 2.0 TDI 16V 4motion, 2.0 TDI 4motion, 3.2, 3.2 R32 4motion	Rubber-metal Bearing	E	'E	'H	BS6899
Rod/Strut, stabiliser	1.4 16V, 1.4 FSI, 1.4 TSI, 1.6, 1.6 FSI, 1.6 MultiFuel, 1.8 GTI, 1.9 TDI, 2.0, 2.0 FSI, 2.0 GTI, 2.0 SDI, 2.0 TDI, 2.0 TDI 16V, 2.0 TDI 16V 4motion, 2.0 TDI 4motion, 3.2, 3.2 R32 4motion	Material: Steel	E	'E	'H	CTR5849
Rod/Strut, stabiliser	1.9 TDI 4motion	Engine Code: BKC; Material: Steel	E	'E	'H	CTR5849
Rod/Strut, stabiliser	2.0 FSI 4motion	Engine Code: BLY; Material: Steel	E	'E	'H	CTR5849
Rod/Strut, stabiliser	2.0 GTI	Engine Code: AXX, BWA; Material: Steel	E	'E	'H	CTR5849
Rod/Strut, stabiliser	3.2 R32 4motion	Engine Code: BUB; Material: Steel	E	'E	'H	CTR5849
Tie Rod Axle Joint	1.4 16V, 1.4 FSI, 1.4 TSI, 1.6, 1.6 FSI, 1.6 MultiFuel, 1.8, 1.8 GTI, 1.8 Hybrid, 1.9 SDI, 1.9 TDI, 1.9 TDI 4motion, 2.0, 2.0 FSI, 2.0 FSI 4motion, 2.0 GTI, 2.0 SDI, 2.0 TDI, 2.0 TDI 16V, 2.0 TDI 16V 4motion, 2.0 TDI 4motion, 3.2, 3.2 R32 4motion		E	'E	'H	RE5841

GOLF Mk VI (5K1, AJ5)

10/2008 → 11/2013

Control Arm-/Trailing Arm Bush	1.2 TSI, 1.4, 1.4 TSI, 1.6, 1.6 BiFuel, 1.6 TDI, 2.0 GTi, 2.0 R 4motion, 2.0 TDI, 2.0 TDI 4motion	Material: Aluminium	E	'E		BS6883
Control Arm-/Trailing Arm Bush	1.2 TSI, 1.4, 1.4 TSI, 1.6, 1.6 BiFuel, 1.6 TDI, 2.0 GTi, 2.0 R 4motion, 2.0 TDI, 2.0 TDI 4motion	Material: Aluminium	E		'H	BS6884
Control Arm-/Trailing Arm Bush	1.2 TSI, 1.4, 1.4 TSI, 1.6, 1.6 BiFuel, 1.6 MultiFuel, 1.6 TDI, 1.8 TSI, 2.0 GTi, 2.0 R 4motion, 2.0 TDI, 2.0 TDI 4motion	Rubber-metal Bearing	E	'E	'H	BS6899
Rod/Strut, stabiliser	1.2 TSI, 1.4, 1.4 TSI, 1.6, 1.6 BiFuel, 1.6 MultiFuel, 1.6 TDI, 1.8 TSI, 2.0 GTi, 2.0 R 4motion, 2.0 TDI, 2.0 TDI 4motion	Material: Steel	E	'E	'H	CTR5849
Tie Rod Axle Joint	1.2 TSI, 1.4, 1.4 TSI, 1.6, 1.6 BiFuel, 1.6 MultiFuel, 1.6 TDI, 1.8 TSI, 2.0 GTi, 2.0 R 4motion, 2.0 TDI, 2.0 TDI 4motion	for vehicles with electric power steering	E	'E	'H	RE5841

BS6417	BS6883	BS6884	BS6899	CJ986	CJ987	CTR5706L
Ref.Nr.: 1J0407181	Ref.Nr.: 1K0199231J	Ref.Nr.: 1K0199232J	Ref.Nr.: 1K0407182	Ref.Nr.: 1J0407365A	Ref.Nr.: 1J0407366H	Ref.Nr.: 1J0422811B
CTR5706R	CTR5849	MO5414	MO6180	RE5841	RE8143	
Ref.Nr.: 1J0422812B	Ref.Nr.: 1K0411315G	Ref.Nr.: 191407181D	Ref.Nr.: 1J0412331B	Ref.Nr.: 1K0423810A	Ref.Nr.: 1J0422807B	

Article Description			Fitting Position	Article No.
---------------------	---	---	------------------	-------------

JETTA Mk I













01/1980 → 12/1985

Track Control Arm	1.3.1.4. 1.5.1.6.1.8		E	'E 'H	CJ108
Ball Joint	1.3.1.4. 1.5.1.6.1.8	17 mm	E	'E 'H	CJ832
Tie Rod End	1.3.1.4. 1.5.1.6.1.8		E	'E 'H	CTR5140
Tie Rod Axle Joint	1.3.1.4. 1.5.1.6.1.8		E	'E 'H	RE033

JETTA Mk II (19E, 1G2, 165)

01/1984 → 07/1992

Control Arm-/Trailing Arm Bush	1.3, 1.3 CAT, 1.6, 1.6D, 1.6TD, 1.8, 1.8 16V, 1.8CAT, 1.8 Syncro		E	'E 'H	BS6911
Ball Joint	1.3, 1.3 CAT, 1.6, 1.6D, 1.6TD, 1.8, 1.8 16V, 1.8CAT, 1.8 Syncro	with fastening material; with accessories, 19 mm	E	'E 'H	CJ864
Ball Joint	1.3, 1.3 CAT, 1.6, 1.6 D, 1.6 TD, 1.8, 1.8 16V, 1.8 CAT	→ 12/1987; with accessories, 17 mm	E	'E 'H	CJ957
Tie Rod End	1.3, 1.3 CAT, 1.6, 1.6D, 1.6TD, 1.8, 1.8 16V, 1.8CAT, 1.8 Syncro		E	'E	CTR5191L
Tie Rod End	1.3, 1.3 CAT, 1.6, 1.6D, 1.6TD, 1.8, 1.8 16V, 1.8CAT, 1.8 Syncro		E	'H	CTR5191R
Repair Kit, link	1.3, 1.3 CAT, 1.6, 1.6D, 1.6TD, 1.8, 1.8 16V, 1.8CAT, 1.8 Syncro	with guide sleeve	E	'E 'H	MO5414
Tie Rod Axle Joint	1.3, 1.3 CAT, 1.6, 1.6D, 1.6TD, 1.8, 1.8 16V, 1.8CAT, 1.8 Syncro	for vehicles without power steering	E	'E 'H	RE5192
Tie Rod Axle Joint	1.3, 1.3 CAT, 1.6, 1.6D, 1.6TD, 1.8, 1.8 16V, 1.8CAT, 1.8 Syncro	for vehicles with power steering	E	'E 'H	RE5473

						
BS6911	CJ108	CJ832	CJ864	CJ957	CTR5140	CTR5191L
Ref.Nr.: 191407182	Ref.Nr.: 171407153D	Ref.Nr.: 171407365F	Ref.Nr.: 357407365	Ref.Nr.: 191407365	Ref.Nr.: 32111116463	Ref.Nr.: 3A0422811
						
CTR5191R	MO5414	RE033	RE5192	RE5473		
Ref.Nr.: 191419812	Ref.Nr.: 191407181D	Ref.Nr.: 171419821	Ref.Nr.: 191419804PAR	Ref.Nr.: 191422804APA		

Article Description			Fitting Position	Article No.
---------------------	---	---	------------------	-------------

JETTA Mk III















01/1992 → 12/1999

Control Arm-/Trailing Arm Bush	1.6 CSL,1.8 CLX,CSX,2.0 CLI 2.8 2.9 VR6	Control Arm Bush Rear ID13/OD60/L41	E	'E	'H	BS6417
Ball Joint	2.0 2.8 VR6 2.9 VR6	16,5 mm	E	'E	'H	CJ1031
Track Control Arm	1.6 CSL,1.8 CLX,CSX,2.0 CLI	Exc VR6	E	'E	'H	CJ111L
Ball Joint	1.6 CSL,1.8 CLX,CSX,2.0 CLI	19 mm Exc VR6	E	'E	'H	CJ864
Tie Rod End	1.6 CSL,1.8 CLX,CSX,2.0 CLI 2.8 2.9 VR6		E	'E		CTR5191L
Tie Rod End	1.6 CSL,1.8 CLX,CSX,2.0 CLI 2.8 2.9 VR6		E		'H	CTR5191R
Repair Kit, link	1.6 CSL,1.8 CLX,CSX,2.0 CLI 2.8 2.9 VR6	Control Arm Bush Rear ID17/OD60/L41	E	'E	'H	MO5414
Top Strut Mounting	1.6 CSL,1.8 CLX,CSX,2.0 CLI 2.8 2.9 VR6	Shock Mounting Front	E	'E	'H	MO6180
Rack End	1.6 CSL,1.8 CLX,CSX,2.0 CLI 2.8 2.9 VR6	P/S	E	'E	'H	RE5438

JETTA Mk IV

01/1999 → 12/2004

Control Arm-/Trailing Arm Bush	1.6I,1.8 GTI,1.9TDI,STD,COMFORTLINE,HIGHLINE		E	'E	'H	BS6417
Repair Kit, ball joint	1.6I,1.8 GTI,1.9TDI,STD,COMFORTLINE,HIGHLINE		E	'E		CJ986
Repair Kit, ball joint	1.6I,1.8 GTI,1.9TDI,STD,COMFORTLINE,HIGHLINE		E		'H	CJ987
Tie Rod End	1.6I,1.8 GTI,1.9TDI,STD,COMFORTLINE,HIGHLINE		E	'E		CTR5706L
Tie Rod End	1.6I,1.8 GTI,1.9TDI,STD,COMFORTLINE,HIGHLINE		E		'H	CTR5706R
Tie Rod Axle Joint	1.6I,1.8 GTI,1.9TDI,STD,COMFORTLINE,HIGHLINE		E	'E	'H	RE8143

						
BS6417	CJ1031	CJ111L	CJ864	CJ986	CJ987	CTR5191L
Ref.Nr.: 1J0407181	Ref.Nr.: 1H0407365	Ref.Nr.: 1H0407151	Ref.Nr.: 357407365	Ref.Nr.: 1J0407365A	Ref.Nr.: 1J0407366H	Ref.Nr.: 3A0422811
						
CTR5191R	CTR5706L	CTR5706R	MO5414	MO6180	RE5438	RE8143
Ref.Nr.: 191419812	Ref.Nr.: 1J0422811B	Ref.Nr.: 1J0422812B	Ref.Nr.: 191407181D	Ref.Nr.: 1J0412331B	Ref.Nr.:	Ref.Nr.: 1J0422807B

Article Description			Fitting Position	Article No.
---------------------	---	---	------------------	-------------

JETTA Mk V (1K1, 1K5)

10/2003 → 02/2009

Control Arm-/Trailing Arm Bush	1.4 16V, 1.4 FSI, 1.4 TSI, 1.6, 1.6 FSI, 1.9 TDI, 1.9 TDI 4motion, 2.0, 2.0 FSI, 2.0 FSI 4motion, 2.0 GTI, 2.0 SDI, 2.0 TDI, 2.0 TDI 16V, 2.0 TDI 16V 4motion, 2.0 TDI 4motion, 3.2, 3.2 R32 4motion	Material: Aluminium	E	E		BS6883
Control Arm-/Trailing Arm Bush	1.4 16V, 1.4 FSI, 1.4 TSI, 1.6, 1.6 FSI, 1.9 TDI, 1.9 TDI 4motion, 2.0, 2.0 FSI, 2.0 FSI 4motion, 2.0 GTI, 2.0 SDI, 2.0 TDI, 2.0 TDI 16V, 2.0 TDI 16V 4motion, 2.0 TDI 4motion, 3.2, 3.2 R32 4motion	Material: Aluminium	E		H	BS6884
Control Arm-/Trailing Arm Bush	1.4 16V, 1.4 FSI, 1.4 TSI, 1.6, 1.6 FSI, 1.6 MultiFuel, 1.8, 1.8 GTI, 1.8 Hybrid, 1.9 SDI, 1.9 TDI, 1.9 TDI 4motion, 2.0, 2.0 FSI, 2.0 FSI 4motion, 2.0 GTI, 2.0 SDI, 2.0 TDI, 2.0 TDI 16V, 2.0 TDI 16V 4motion, 2.0 TDI 4motion, 3.2, 3.2 R32 4motion	Rubber-metal Bearing	E	E	H	BS6899
Rod/Strut, stabiliser	1.4 16V, 1.4 FSI, 1.4 TSI, 1.6, 1.6 FSI, 1.6 MultiFuel, 1.8 GTI, 1.9 TDI, 2.0, 2.0 FSI, 2.0 GTI, 2.0 SDI, 2.0 TDI, 2.0 TDI 16V, 2.0 TDI 16V 4motion, 2.0 TDI 4motion, 3.2, 3.2 R32 4motion	Material: Steel	E	E	H	CTR5849
Rod/Strut, stabiliser	1.9 TDI 4motion	Engine Code: BKC; Material: Steel	E	E	H	CTR5849
Rod/Strut, stabiliser	2.0 FSI 4motion	Engine Code: BLY; Material: Steel	E	E	H	CTR5849
Rod/Strut, stabiliser	2.0 GTI	Engine Code: AXX, BWA; Material: Steel	E	E	H	CTR5849
Rod/Strut, stabiliser	3.2 R32 4motion	Engine Code: BUB; Material: Steel	E	E	H	CTR5849
Tie Rod Axle Joint	1.4 16V, 1.4 FSI, 1.4 TSI, 1.6, 1.6 FSI, 1.6 MultiFuel, 1.8, 1.8 GTI, 1.8 Hybrid, 1.9 SDI, 1.9 TDI, 1.9 TDI 4motion, 2.0, 2.0 FSI, 2.0 FSI 4motion, 2.0 GTI, 2.0 SDI, 2.0 TDI, 2.0 TDI 16V, 2.0 TDI 16V 4motion, 2.0 TDI 4motion, 3.2, 3.2 R32 4motion		E	E	H	RE5841

JETTA Mk VI (5K1, AJ5)

10/2008 → 11/2013

Control Arm-/Trailing Arm Bush	1.2 TSI, 1.4, 1.4 TSI, 1.6, 1.6 BiFuel, 1.6 TDI, 2.0 GTI, 2.0 R 4motion, 2.0 TDI, 2.0 TDI 4motion	Material: Aluminium	E	E		BS6883
Control Arm-/Trailing Arm Bush	1.2 TSI, 1.4, 1.4 TSI, 1.6, 1.6 BiFuel, 1.6 TDI, 2.0 GTI, 2.0 R 4motion, 2.0 TDI, 2.0 TDI 4motion	Material: Aluminium	E		H	BS6884
Control Arm-/Trailing Arm Bush	1.2 TSI, 1.4, 1.4 TSI, 1.6, 1.6 BiFuel, 1.6 MultiFuel, 1.6 TDI, 1.8 TSI, 2.0 GTI, 2.0 R 4motion, 2.0 TDI, 2.0 TDI 4motion	Rubber-metal Bearing	E	E	H	BS6899
Rod/Strut, stabiliser	1.2 TSI, 1.4, 1.4 TSI, 1.6, 1.6 BiFuel, 1.6 MultiFuel, 1.6 TDI, 1.8 TSI, 2.0 GTI, 2.0 R 4motion, 2.0 TDI, 2.0 TDI 4motion	Material: Steel	E	E	H	CTR5849
Tie Rod Axle Joint	1.2 TSI, 1.4, 1.4 TSI, 1.6, 1.6 BiFuel, 1.6 MultiFuel, 1.6 TDI, 1.8 TSI, 2.0 GTI, 2.0 R 4motion, 2.0 TDI, 2.0 TDI 4motion	for vehicles with electric power steering	E	E	H	RE5841

LT Mk II Bus (2DB, 2DE, 2DK)

05/1996 → 07/2006

Tie Rod End	2.3, 2.5 SDI, 2.5 TDI, 2.8 TDi		E	E	H	CTR5542
-------------	--------------------------------	--	---	---	---	---------

LT Mk II Box (2DA, 2DD, 2DH)

05/1996 → 07/2006

Tie Rod End	2.3, 2.5 SDI, 2.5 TDI, 2.8 TDI		E	E	H	CTR5542
-------------	--------------------------------	--	---	---	---	---------

LT Mk II Platform/Chassis (2DC, 2DF, 2DG, 2DL, 2DM)











06/1996 → 07/2006

Tie Rod End	2.3, 2.5 SDI, 2.5 TDI, 2.8 TDI		E	E	H	CTR5542
-------------	--------------------------------	--	---	---	---	---------

PASSAT (3A2, 35I)

02/1988 → 08/1996

Control Arm-/Trailing Arm Bush	1.6, 1.6TD, 1.8, 1.8 16V, 1.8 G60 Syncro, 1.9D, 1.9TD, 1.9 TDI, 2.0, 2.0 16V, 2.0 Syncro, 2.8 VR6		E	E	H	BS6911
Ball Joint	1.9 TDI, 2.0 16V		E	E	H	CJ1031
Ball Joint	2.8 VR6	ch.31-N-255990→; 01/1992 →	E	E	H	CJ1031
Ball Joint	1.6, 1.6TD, 1.8, 1.8 16V, 1.9D, 1.9TD, 1.9 TDI, 2.0, 2.0 16V	with fastening material; with accessories	E	E	H	CJ864
Tie Rod End	1.6, 1.6TD, 1.8, 1.8 16V, 1.8 G60 Syncro, 1.9D, 1.9TD, 1.9 TDI, 2.0, 2.0 16V, 2.0 Syncro, 2.8 VR6	ch.3A-R-0099265→	E	E		CTR5191L

						
BS6883	BS6884	BS6899	BS6911	CJ1031	CJ864	CTR5191L
Ref.Nr.: 1K0199231J	Ref.Nr.: 1K0199232J	Ref.Nr.: 1K0407182	Ref.Nr.: 191407182	Ref.Nr.: 1H0407365	Ref.Nr.: 357407365	Ref.Nr.: 3A0422811
						
CTR5542	CTR5849	RE5841				
Ref.Nr.: 2D0422811	Ref.Nr.: 1K0411315G	Ref.Nr.: 1K0423810A				

Article Description			Fitting Position	Article No.
---------------------	--	--	------------------	-------------

PASSAT (3A2, 35I)

02/1988 → 08/1996

Tie Rod End	1.6, 1.6TD, 1.8, 1.8 16V, 1.8G60Syncro, 1.9D, 1.9TD, 1.9 TDI, 2.0, 2.0 16V, 2.0 Syncro, 2.8 VR6	ch.3A-R-0099265→	E		H	CTR5191R
Repair Kit, link	1.6, 1.6TD, 1.8, 1.8 16V, 1.8G60Syncro, 1.9D, 1.9TD, 1.9 TDI, 2.0, 2.0 16V, 2.0 Syncro, 2.8 VR6	with guide sleeve	E	E	H	MO5414

PASSAT Variant (3A5, 35I)

02/1988 → 05/1997

Control Arm-/Trailing Arm Bush	1.6, 1.6TD, 1.8, 1.8 16V, 1.8G60Syncro, 1.9D, 1.9TD, 1.9 TDI, 2.0, 2.0 16V, 2.0 Syncro, 2.8 VR6, 2.9 VR6 Syncro		E	E	H	BS6911
Ball Joint	1.9 TDI, 2.0 16V, 2.9 VR6 Syncro		E	E	H	CJ1031
Ball Joint	2.8 VR6	ch.31-N-255990→; 01/1992 →	E	E	H	CJ1031
Ball Joint	1.6, 1.6TD, 1.8, 1.8 16V, 1.9D, 1.9TD, 1.9 TDI, 2.0, 2.0 16V, 2.0 Syncro	with fastening material; with accessories	E	E	H	CJ864
Ball Joint	1.8 G60 Syncro	01/1990 →; with fastening material; with accessories	E	E	H	CJ864
Tie Rod End	1.6, 1.6TD, 1.8, 1.8 16V, 1.8G60Syncro, 1.9D, 1.9TD, 1.9 TDI, 2.0, 2.0 16V, 2.0 Syncro, 2.8 VR6, 2.9 VR6 Syncro	ch.3A-R-0099265→	E	E		CTR5191L
Tie Rod End	1.6, 1.6TD, 1.8, 1.8 16V, 1.8G60Syncro, 1.9D, 1.9TD, 1.9 TDI, 2.0, 2.0 16V, 2.0 Syncro, 2.8 VR6, 2.9 VR6 Syncro	ch.3A-R-0099265→	E		H	CTR5191R
Repair Kit, link	1.6, 1.6TD, 1.8, 1.8 16V, 1.8G60Syncro, 1.9D, 1.9TD, 1.9 TDI, 2.0, 2.0 16V, 2.0 Syncro, 2.8 VR6, 2.9 VR6 Syncro	with guide sleeve	E	E	H	MO5414

PASSAT (3B2)

08/1996 → 12/2001

Control Arm-/Trailing Arm Bush	1.6, 1.8, 1.8 Syncro/4motion, 1.8 T, 1.9 TDI, 1.9 TDI 4motion, 1.9 TDI Syncro/4motion, 2.0, 2.0 4motion, 2.3 VR5, 2.3 VR5 Syncro/4motion, 2.5 TDI, 2.5 TDI Syncro/4motion, 2.8 V6, 2.8 V6 Syncro/4motion		E	E	H	BS6911
Control Arm-/Trailing Arm Bush	1.6, 1.8, 1.8 Syncro/4motion, 1.8 T, 1.9 TDI, 1.9 TDI Syncro/4motion, 2.3 VR5, 2.3 VR5 Syncro/4motion, 2.5 TDI, 2.8 V6, 2.8 V6 Syncro/4motion	Rubber-metal Bearing; 01/1997 →	E	E	H	BS7069
Control Arm-/Trailing Arm Bush	1.6, 1.8, 1.8 Syncro/4motion, 1.8 T, 1.9 TDI, 1.9 TDI Syncro/4motion, 2.3 VR5, 2.3 VR5 Syncro/4motion, 2.5 TDI, 2.8 V6, 2.8 V6 Syncro/4motion	01/1997 →	E	E	H	BS7072
Control Arm-/Trailing Arm Bush	1.9 TDI 4motion	ch.→3B-VP-102593	E	E	H	BS7072
Control Arm-/Trailing Arm Bush	2.5 TDI Syncro/4motion	for OE: 8D0407505B	E	E	H	BS7072
Track Control Arm	1.6, 1.8, 1.8 Syncro/4motion, 1.8 T, 1.9 TDI, 1.9 TDI 4motion, 1.9 TDI Syncro/4motion, 2.3 VR5, 2.3 VR5 Syncro/4motion, 2.5 TDI, 2.5 TDI Syncro/4motion, 2.8 V6, 2.8 V6 Syncro/4motion		E		H	CJ1033
Track Control Arm	1.6, 1.8, 1.8 Syncro/4motion, 1.8 T, 1.9 TDI, 1.9 TDI 4motion, 1.9 TDI Syncro/4motion, 2.3 VR5, 2.3 VR5 Syncro/4motion, 2.5 TDI, 2.5 TDI Syncro/4motion, 2.8 V6, 2.8 V6 Syncro/4motion		E	E		CJ1034
Track Control Arm	1.6, 1.8, 1.8 Syncro/4motion, 1.8 T, 1.9 TDI, 1.9 TDI 4motion, 1.9 TDI Syncro/4motion, 2.3 VR5, 2.3 VR5 Syncro/4motion, 2.5 TDI, 2.5 TDI Syncro/4motion, 2.8 V6, 2.8 V6 Syncro/4motion		E		H	CJ1035
Track Control Arm	1.6, 1.8, 1.8 Syncro/4motion, 1.8 T, 1.9 TDI, 1.9 TDI 4motion, 1.9 TDI Syncro/4motion, 2.3 VR5, 2.3 VR5 Syncro/4motion, 2.5 TDI, 2.5 TDI Syncro/4motion, 2.8 V6, 2.8 V6 Syncro/4motion		E	E		CJ287
Track Control Arm	1.6, 1.8, 1.8 Syncro/4motion, 1.8 T, 1.8 T Syncro, 1.9 TDI, 1.9 TDI 4motion, 1.9 TDI Syncro/4motion, 2.0, 2.0 4motion, 2.3 VR5, 2.3 VR5 Syncro/4motion, 2.5 TDI, 2.5 TDI Syncro/4motion, 2.8 Syncro, 2.8 V6, 2.8 V6 Syncro/4motion		E	E		CJ292

BS6911	BS7069	BS7072	CJ1031	CJ1033	CJ1034	CJ1035
Ref.Nr.: 191407182	Ref.Nr.: 4D0407183P	Ref.Nr.: 4D0407515	Ref.Nr.: 1H0407365	Ref.Nr.: 8D0407506H	Ref.Nr.: 4D0407509K	Ref.Nr.: 4D0407510B
CJ287	CJ292	CJ864	CTR5191L	CTR5191R	MO5414	
Ref.Nr.: 8D0407505B	Ref.Nr.: 4D0407693E	Ref.Nr.: 357407365	Ref.Nr.: 3A0422811	Ref.Nr.: 191419812	Ref.Nr.: 191407181D	

Article Description			Fitting Position	Article No.
---------------------	---	---	------------------	-------------

PASSAT (3B2)

08/1996 → 12/2001

Track Control Arm	1.6, 1.8, 1.8 Syncro/4motion, 1.8 T, 1.8 T Syncro, 1.9 TDI, 1.9 TDI 4motion, 1.9 TDI Syncro/4motion, 2.0, 2.0 4motion, 2.3 VR5, 2.3 VR5 Syncro/4motion, 2.5 TDI, 2.5 TDI Syncro/4motion, 2.8 Syncro, 2.8 V6, 2.8 V6 Syncro/4motion		E		H	CJ293
Tie Rod End	1.6, 1.8, 1.8 Syncro/4motion, 1.8 T, 1.8 T Syncro, 1.9 TDI, 1.9 TDI 4motion, 1.9 TDI Syncro/4motion, 2.0, 2.0 4motion, 2.3 VR5, 2.3 VR5 Syncro/4motion, 2.5 TDI, 2.5 TDI Syncro/4motion, 2.8 Syncro, 2.8 V6, 2.8 V6 Syncro/4motion	with screw	E	E	H	CTR5491

PASSAT Estate (3B5)











05/1997 → 12/2001

Control Arm-/Trailing Arm Bush	1.6, 1.8, 1.8 Syncro/4motion, 1.8 T, 1.9 TDI, 1.9 TDI 4motion, 1.9 TDI Syncro/4motion, 2.0, 2.0 4motion, 2.3 VR5, 2.3 VR5 Syncro/4motion, 2.5 TDI, 2.5 TDI Syncro/4motion, 2.8 V6, 2.8 V6 Syncro/4motion		E	E	H	BS6911
Control Arm-/Trailing Arm Bush	1.6, 1.8, 1.8 Syncro/4motion, 1.8 T, 1.9 TDI, 1.9 TDI Syncro/4motion, 2.3 VR5, 2.3 VR5 Syncro/4motion, 2.5 TDI, 2.8 V6, 2.8 V6 Syncro/4motion	Rubber-metal Bearing	E	E	H	BS7069
Control Arm-/Trailing Arm Bush	1.6, 1.8, 1.8 Syncro/4motion, 1.8 T, 1.9 TDI, 1.9 TDI Syncro/4motion, 2.3 VR5, 2.3 VR5 Syncro/4motion, 2.5 TDI, 2.8 V6, 2.8 V6 Syncro/4motion		E	E	H	BS7072
Control Arm-/Trailing Arm Bush	1.9 TDI 4motion, 2.5 TDI Syncro/4motion	for OE: 8D0407505B	E	E	H	BS7072
Track Control Arm	1.6, 1.8, 1.8 Syncro/4motion, 1.8 T, 1.9 TDI, 1.9 TDI 4motion, 1.9 TDI Syncro/4motion, 2.3 VR5, 2.3 VR5 Syncro/4motion, 2.5 TDI, 2.5 TDI Syncro/4motion, 2.8 V6, 2.8 V6 Syncro/4motion		E		H	CJ1033
Track Control Arm	1.6, 1.8, 1.8 Syncro/4motion, 1.8 T, 1.9 TDI, 1.9 TDI 4motion, 1.9 TDI Syncro/4motion, 2.3 VR5, 2.3 VR5 Syncro/4motion, 2.5 TDI, 2.5 TDI Syncro/4motion, 2.8 V6, 2.8 V6 Syncro/4motion		E	E		CJ1034
Track Control Arm	1.6, 1.8, 1.8 Syncro/4motion, 1.8 T, 1.9 TDI, 1.9 TDI 4motion, 1.9 TDI Syncro/4motion, 2.3 VR5, 2.3 VR5 Syncro/4motion, 2.5 TDI, 2.5 TDI Syncro/4motion, 2.8 V6, 2.8 V6 Syncro/4motion		E		H	CJ1035
Track Control Arm	1.6, 1.8, 1.8 Syncro/4motion, 1.8 T, 1.9 TDI, 1.9 TDI 4motion, 1.9 TDI Syncro/4motion, 2.3 VR5, 2.3 VR5 Syncro/4motion, 2.5 TDI, 2.5 TDI Syncro/4motion, 2.8 V6, 2.8 V6 Syncro/4motion		E	E		CJ287
Track Control Arm	1.6, 1.8, 1.8 Syncro/4motion, 1.8 T, 1.9 TDI, 1.9 TDI 4motion, 1.9 TDI Syncro/4motion, 2.0, 2.0 4motion, 2.3 VR5, 2.3 VR5 Syncro/4motion, 2.5 TDI, 2.5 TDI Syncro/4motion, 2.8 Syncro, 2.8 V6, 2.8 V6 Syncro/4motion		E	E		CJ292
Track Control Arm	1.6, 1.8, 1.8 Syncro/4motion, 1.8 T, 1.9 TDI, 1.9 TDI 4motion, 1.9 TDI Syncro/4motion, 2.0, 2.0 4motion, 2.3 VR5, 2.3 VR5 Syncro/4motion, 2.5 TDI, 2.5 TDI Syncro/4motion, 2.8 Syncro, 2.8 V6, 2.8 V6 Syncro/4motion		E		H	CJ293
Tie Rod End	1.6, 1.8, 1.8 Syncro/4motion, 1.8 T, 1.9 TDI, 1.9 TDI 4motion, 1.9 TDI Syncro/4motion, 2.0, 2.0 4motion, 2.3 VR5, 2.3 VR5 Syncro/4motion, 2.5 TDI, 2.5 TDI Syncro/4motion, 2.8 Syncro, 2.8 V6, 2.8 V6 Syncro/4motion	with screw	E	E	H	CTR5491

PASSAT (3B3)

11/2000 → 05/2005

Control Arm-/Trailing Arm Bush	1.6, 1.9 TDI, 2.0, 2.3 V5	for OE: 8D0407505B	E	E	H	BS7072
Track Control Arm	1.6, 1.9 TDI, 2.0, 2.3 V5		E		H	CJ1033
Track Control Arm	1.6, 1.8 T 20V, 1.9 TDI, 1.9 TDI 4motion, 2.0, 2.0 4motion, 2.3 V5, 2.3 V5 4motion, 2.5 TDI, 2.5 TDI 4motion, 2.8 4motion		E	E		CJ1034
Track Control Arm	1.6, 1.8 T 20V, 1.9 TDI, 1.9 TDI 4motion, 2.0, 2.0 4motion, 2.3 V5, 2.3 V5 4motion, 2.5 TDI, 2.5 TDI 4motion, 2.8 4motion		E		H	CJ1035

						
BS6911	BS7069	BS7072	CJ1033	CJ1034	CJ1035	CJ287
Ref.Nr.: 191407182	Ref.Nr.: 4D0407183P	Ref.Nr.: 4D0407515	Ref.Nr.: 8D0407506H	Ref.Nr.: 4D0407509K	Ref.Nr.: 4D0407510B	Ref.Nr.: 8D0407505B
						
CJ292	CJ293	CTR5491				
Ref.Nr.: 4D0407693E	Ref.Nr.: 4D0407694K	Ref.Nr.: 4B0419811B				

Article Description			Fitting Position	Article No.
---------------------	--	--	------------------	-------------

PASSAT (3B3)

11/2000 → 05/2005

Track Control Arm	1.6, 1.9 TDI, 2.0, 2.3 V5		E	'E		CJ287
Track Control Arm	1.6, 1.8, 1.8 T, 1.8 T 20V, 1.8 T 4motion, 1.9 TDI, 1.9 TDI 4motion, 2.0, 2.0 4motion, 2.0 TDI, 2.3 V5, 2.3 V5 4motion, 2.5 TDI, 2.5 TDI 4motion, 2.8 4motion, 4.0 W8 4motion		E	'E		CJ292
Track Control Arm	1.6, 1.8, 1.8 T, 1.8 T 20V, 1.8 T 4motion, 1.9 TDI, 1.9 TDI 4motion, 2.0, 2.0 4motion, 2.0 TDI, 2.3 V5, 2.3 V5 4motion, 2.5 TDI, 2.5 TDI 4motion, 2.8 4motion, 4.0 W8 4motion		E		'H	CJ293
Tie Rod End	1.6, 1.8, 1.8 T, 1.8 T 20V, 1.8 T 4motion, 1.9 TDI, 1.9 TDI 4motion, 2.0, 2.0 4motion, 2.0 TDI, 2.3 V5, 2.3 V5 4motion, 2.5 TDI, 2.5 TDI 4motion, 2.8 4motion, 4.0 W8 4motion	with screw	E	'E	'H	CTR5491

PASSAT Variant (3B6)

11/2000 → 08/2005

Control Arm-/Trailing Arm Bush	1.6, 1.9 TDI, 2.0, 2.3 VR5	for OE: 8D0407505B	E	'E	'H	BS7072
Track Control Arm	1.6, 1.9 TDI, 2.0, 2.3 VR5		E		'H	CJ1033
Track Control Arm	1.6, 1.8 T 20V, 1.9 TDI, 1.9 TDI 4motion, 2.0, 2.0 4motion, 2.3 VR5, 2.3 VR5 4motion, 2.5 TDI, 2.5 TDI 4motion, 2.8 4motion		E	'E		CJ1034
Track Control Arm	1.6, 1.8 T 20V, 1.9 TDI, 1.9 TDI 4motion, 2.0, 2.0 4motion, 2.3 VR5, 2.3 VR5 4motion, 2.5 TDI, 2.5 TDI 4motion, 2.8 4motion		E		'H	CJ1035
Track Control Arm	1.6, 1.9 TDI, 2.0, 2.3 VR5	for OE: 8D0407505B	E	'E		CJ287
Track Control Arm	1.6, 1.8 4motion, 1.8 T, 1.8 T 20V, 1.9 TDI, 1.9 TDI 4motion, 2.0, 2.0 4motion, 2.0 TDI, 2.3 VR5, 2.3 VR5 4motion, 2.5 TDI, 2.5 TDI 4motion, 2.8 4motion, 4.0 W8 4motion		E	'E		CJ292
Track Control Arm	1.6, 1.8 4motion, 1.8 T, 1.8 T 20V, 1.9 TDI, 1.9 TDI 4motion, 2.0, 2.0 4motion, 2.0 TDI, 2.3 VR5, 2.3 VR5 4motion, 2.5 TDI, 2.5 TDI 4motion, 2.8 4motion, 4.0 W8 4motion		E		'H	CJ293
Tie Rod End	1.6, 1.8 4motion, 1.8 T, 1.8 T 20V, 1.9 TDI, 1.9 TDI 4motion, 2.0, 2.0 4motion, 2.0 TDI, 2.3 VR5, 2.3 VR5 4motion, 2.5 TDI, 2.5 TDI 4motion, 2.8 4motion, 4.0 W8 4motion	with screw	E	'E	'H	CTR5491

PASSAT (3C2)

03/2005 → 11/2010

Control Arm-/Trailing Arm Bush	1.4 TSI, 1.4 TSI EcoFuel, 1.6, 1.6 FSI, 1.6 TDI, 1.8 TSI, 1.9 TDI, 2.0 BlueTDI, 2.0 FSI, 2.0 FSI 4motion, 2.0 TDI, 2.0 TDI 16V, 2.0 TDI 16V 4motion, 2.0 TDI 4motion, 3.2 FSI 4motion, 3.6 R36 4motion	Rubber-metal Bearing	E	'E	'H	BS6899
Rod/Strut, stabiliser	1.4 TSI, 1.4 TSI EcoFuel, 1.6, 1.6 FSI, 1.6 TDI, 1.8 TSI, 2.0 BlueTDI, 2.0 FSI, 2.0 TDI, 2.0 TDI 4motion, 3.2 FSI 4motion, 3.6 R36 4motion	Material: Steel	E	'E	'H	CTR5849
Rod/Strut, stabiliser	1.9 TDI	Engine Code: BKC; Material: Steel	E	'E	'H	CTR5849
Rod/Strut, stabiliser	2.0 FSI	Engine Code: AXG; Material: Steel	E	'E	'H	CTR5849
Rod/Strut, stabiliser	2.0 FSI	Engine Code: BLR, BLY; Material: Steel	E	'E	'H	CTR5849
Rod/Strut, stabiliser	2.0 FSI 4motion	Engine Code: BVX; Material: Steel	E	'E	'H	CTR5849
Rod/Strut, stabiliser	2.0 TDI 16V, 2.0 TDI 16V 4motion	Engine Code: BKP; Material: Steel	E	'E	'H	CTR5849
Tie Rod Axle Joint	1.4 TSI, 1.4 TSI EcoFuel, 1.6, 1.6 FSI, 1.6 TDI, 1.8 TSI, 1.9 TDI, 2.0 BlueTDI, 2.0 FSI, 2.0 FSI 4motion, 2.0 TDI, 2.0 TDI 16V, 2.0 TDI 16V 4motion, 2.0 TDI 4motion, 3.2 FSI 4motion, 3.6 R36 4motion		E	'E	'H	RE5841

PASSAT Variant (3C5)

08/2005 → 10/2011

Control Arm-/Trailing Arm Bush	1.4 TSI, 1.4 TSI EcoFuel, 1.6, 1.6 FSI, 1.6 TDI, 1.8 TSI, 1.9 TDI, 2.0 BlueTDI, 2.0 FSI, 2.0 FSI 4motion, 2.0 TDI, 2.0 TDI 16V, 2.0 TDI 16V 4motion, 2.0 TDI 4motion, 3.2 FSI 4motion, 3.6 R36 4motion	Rubber-metal Bearing	E	'E	'H	BS6899
--------------------------------	--	----------------------	---	----	----	--------

BS6899	BS7072	CJ1033	CJ1034	CJ1035	CJ287	CJ292
Ref.Nr.: 1K0407182	Ref.Nr.: 4D0407515	Ref.Nr.: 8D0407506H	Ref.Nr.: 4D0407509K	Ref.Nr.: 4D0407510B	Ref.Nr.: 8D0407505B	Ref.Nr.: 4D0407693E
CJ293	CTR5491	CTR5849	RE5841			
Ref.Nr.: 4D0407694K	Ref.Nr.: 4B0419811B	Ref.Nr.: 1K0411315G	Ref.Nr.: 1K0423810A			

Article Description			Fitting Position	Article No.
---------------------	---	---	------------------	-------------

PASSAT Variant (3C5)

08/2005 → 10/2011

Rod/Strut, stabiliser	1.4 TSI, 1.4 TSI EcoFuel, 1.6, 1.6 FSI, 1.6 TDI, 1.8 TSI, 2.0 Blue TDI, 2.0 FSI, 2.0 TDI, 2.0 TDI 16V 4motion, 2.0 TDI 4motion, 3.2 FSI 4motion, 3.6 R36 4motion	Material: Steel	E	E	H	CTR5849
Rod/Strut, stabiliser	1.9 TDI	Engine Code: BKC, BLS; Material: Steel	E	E	H	CTR5849
Rod/Strut, stabiliser	2.0 FSI	Engine Code: AXG; Material: Steel	E	E	H	CTR5849
Rod/Strut, stabiliser	2.0 FSI	Engine Code: BLR, BLY; Material: Steel	E	E	H	CTR5849
Rod/Strut, stabiliser	2.0 FSI 4motion	Engine Code: BVX; Material: Steel	E	E	H	CTR5849
Rod/Strut, stabiliser	2.0 TDI	Engine Code: BMA; Material: Steel	E	E	H	CTR5849
Rod/Strut, stabiliser	2.0 TDI	Engine Code: BVE; Material: Steel	E	E	H	CTR5849
Rod/Strut, stabiliser	2.0 TDI 16V	Engine Code: BKP; Material: Steel	E	E	H	CTR5849
Tie Rod Axle Joint	1.4 TSI, 1.4 TSI EcoFuel, 1.6, 1.6 FSI, 1.6 TDI, 1.8 TSI, 1.9 TDI, 2.0 Blue TDI, 2.0 FSI, 2.0 FSI 4motion, 2.0 TDI, 2.0 TDI 16V, 2.0 TDI 16V 4motion, 2.0 TDI 4motion, 3.2 FSI 4motion, 3.6 R36 4motion		E	E	H	RE5841

PASSAT CC (357)

05/2008 → 01/2012

Control Arm-/Trailing Arm Bush	1.4 TSI MultiFuel, 1.8 TSI, 2.0 Blue TDI, 2.0 TDI, 2.0 TDI 4motion, 2.0 TSI, 3.6 FSI 4motion	Rubber-metal Bearing	E	E	H	BS6899
Rod/Strut, stabiliser	1.8 TSI, 2.0 Blue TDI, 2.0 TDI, 2.0 TDI 4motion, 2.0 TSI, 3.6 FSI 4motion	Material: Steel	E	E	H	CTR5849
Tie Rod Axle Joint	1.8 TSI, 2.0 Blue TDI, 2.0 TDI, 2.0 TDI 4motion, 2.0 TSI, 3.6 FSI 4motion	for vehicles with electric power steering	E	E	H	RE5841

PASSAT (362)

08/2010 → 12/2014

Control Arm-/Trailing Arm Bush	1.4 TSI, 1.4 TSI EcoFuel, 1.4 TSI MultiFuel, 1.6 TDI, 1.8 TSI, 2.0 TDI, 2.0 TDI 4motion, 2.0 TSI, 3.6 FSI 4motion	Rubber-metal Bearing	E	E	H	BS6899
Rod/Strut, stabiliser	1.4 TSI, 1.4 TSI EcoFuel, 1.4 TSI MultiFuel, 1.6 TDI, 1.8 TSI, 2.0 TDI, 2.0 TDI 4motion, 2.0 TSI, 3.6 FSI 4motion	Material: Steel	E	E	H	CTR5849
Tie Rod Axle Joint	1.4 TSI, 1.4 TSI EcoFuel, 1.4 TSI MultiFuel, 1.6 TDI, 1.8 TSI, 2.0 TDI, 2.0 TDI 4motion, 2.0 TSI, 3.6 FSI 4motion		E	E	H	RE5841

PASSAT Variant (365)

08/2010 → 12/2014

Control Arm-/Trailing Arm Bush	1.4 TSI, 1.4 TSI EcoFuel, 1.4 TSI MultiFuel, 1.6 TDI, 1.8 TSI, 2.0 TDI, 2.0 TDI 4motion, 2.0 TSI, 3.6 FSI 4motion	Rubber-metal Bearing	E	E	H	BS6899
Rod/Strut, stabiliser	1.4 TSI, 1.4 TSI EcoFuel, 1.4 TSI MultiFuel, 1.6 TDI, 1.8 TSI, 2.0 TDI, 2.0 TDI 4motion, 2.0 TSI, 3.6 FSI 4motion	Material: Steel	E	E	H	CTR5849
Tie Rod Axle Joint	1.4 TSI, 1.4 TSI EcoFuel, 1.4 TSI MultiFuel, 1.6 TDI, 1.8 TSI, 2.0 TDI, 2.0 TDI 4motion, 2.0 TSI, 3.6 FSI 4motion		E	E	H	RE5841

PASSAT ALLTRACK (365)



01/2012 → 12/2014

Control Arm-/Trailing Arm Bush	2.0 TSI 4motion	Rubber-metal Bearing	E	E	H	BS6899
Rod/Strut, stabiliser	2.0 TSI 4motion	Material: Steel	E	E	H	CTR5849

POLO Mk I

01/1996 → 12/2003

Control Arm-/Trailing Arm Bush	1.4I, 1.6I, 1.8I, 2.0I CLASSIC, PLAYA	Control Arm Bush Front OD33.5 mm	E	E	H	BS6911
Ball Joint	1.4I, 1.6I, 1.8I, 2.0I CLASSIC, PLAYA	19 mm	E	E	H	CJ864
Tie Rod End	1.4I, 1.6I, 1.8I, 2.0I CLASSIC, PLAYA		E	E		CTR5191L
Tie Rod End	1.4I, 1.6I, 1.8I, 2.0I CLASSIC, PLAYA		E		H	CTR5191R
Repair Kit, link	1.4I, 1.6I, 1.8I, 2.0I CLASSIC, PLAYA	Control Arm Bush Rear ID17/OD60/L41	E	E	H	MO5414
Top Strut Mounting	1.4I, 1.6I, 1.8I, 2.0I CLASSIC, PLAYA	Shock Mounting Front	E	E	H	MO6180

						
BS6899	BS6911	CJ864	CTR5191L	CTR5191R	CTR5849	MO5414
Ref.Nr.: 1K0407182	Ref.Nr.: 191407182	Ref.Nr.: 357407365	Ref.Nr.: 3A0422811	Ref.Nr.: 191419812	Ref.Nr.: 1K0411315G	Ref.Nr.: 191407181D
						
MO6180	RE5841					
Ref.Nr.: 1J0412331B	Ref.Nr.: 1K0423810A					

Article Description			Fitting Position	Article No.
---------------------	---	---	------------------	-------------

POLO Mk I









01/1996 → 12/2003

Rack End	1.4I,1.6I,1.8I,2.0I CLASSIC,PLAYA	P/S Long	E	'E	'H	RE5512
Rack End	1.4I,1.6I,1.8I,2.0I CLASSIC,PLAYA	M/S Short	E	'E	'H	RE5712

POLO Mk II

01/2003 → 12/2010

Ball Joint	1.4,1.6,1.8,1.9TDI,2.0 CLASIC,TRENDLINE,COMFORTLINE,HIGHLINE		E		'H	CJ1090
Ball Joint	1.4,1.6,1.8,1.9TDI,2.0 CLASIC,TRENDLINE,COMFORTLINE,HIGHLINE		E	'E		CJ1091
Track Control Arm	1.4,1.6,1.8,1.9TDI,2.0 CLASIC,TRENDLINE,COMFORTLINE,HIGHLINE		E	'E	'H	CJ205L
Rod/Strut, stabiliser	1.4,1.6,1.8,1.9TDI,2.0 CLASIC,TRENDLINE,COMFORTLINE,HIGHLINE		E	'E	'H	CTR5605
Tie Rod End	1.4,1.6,1.8,1.9TDI,2.0 CLASIC,TRENDLINE,COMFORTLINE,HIGHLINE		E	'E		CTR5706L
Tie Rod End	1.4,1.6,1.8,1.9TDI,2.0 CLASIC,TRENDLINE,COMFORTLINE,HIGHLINE		E		'H	CTR5706R
Tie Rod End	1.4,1.6,1.8,1.9TDI,2.0 CLASIC,TRENDLINE,COMFORTLINE,HIGHLINE		E	'E		CTR5834L
Tie Rod End	1.4,1.6,1.8,1.9TDI,2.0 CLASIC,TRENDLINE,COMFORTLINE,HIGHLINE		E		'H	CTR5834R
Tie Rod Axle Joint	1.4,1.6,1.8,1.9TDI,2.0 CLASIC,TRENDLINE,COMFORTLINE,HIGHLINE	M/S	E	'E	'H	RE0185
Rack End	1.4,1.6,1.8,1.9TDI,2.0 CLASIC,TRENDLINE,COMFORTLINE,HIGHLINE	M/S Short	E	'E	'H	RE5712
Tie Rod Axle Joint	1.4,1.6,1.8,1.9TDI,2.0 CLASIC,TRENDLINE,COMFORTLINE,HIGHLINE	P/S Long	E	'E	'H	RE5870

						
CJ1090	CJ1091	CJ205L	CTR5605	CTR5706L	CTR5706R	CTR5834L
Ref.Nr.: 6Q0407365M	Ref.Nr.: 6Q0407366M	Ref.Nr.: 6Q0407151L	Ref.Nr.: 6Q0411315E	Ref.Nr.: 1J0422811B	Ref.Nr.: 1J0422812B	Ref.Nr.: 6Q0423811A
						
CTR5834R	RE0185	RE5512	RE5712	RE5870		
Ref.Nr.: 6Q0423812	Ref.Nr.: 6X0422804A	Ref.Nr.:	Ref.Nr.: 6Q0423803PPA	Ref.Nr.: 6Q0423804EPA		

Article Description			Fitting Position	Article No.
---------------------	---	---	------------------	-------------

POLO Mk III /VIVO











01/2010 →

Ball Joint	1.4,1.6, TRENDLINE,HATCH & SEDAN		E		H	CJ1090
Ball Joint	1.4,1.6, TRENDLINE,HATCH & SEDAN		E	E		CJ1091
Rod/Strut, stabiliser	1.4,1.6, TRENDLINE,HATCH & SEDAN		E	E	H	CTR5605
Tie Rod End	1.4,1.6, TRENDLINE,HATCH & SEDAN		E	E		CTR5706L
Tie Rod End	1.4,1.6, TRENDLINE,HATCH & SEDAN		E		H	CTR5706R
Tie Rod End	1.4,1.6, TRENDLINE,HATCH & SEDAN		E	E		CTR5834L
Tie Rod End	1.4,1.6, TRENDLINE,HATCH & SEDAN		E		H	CTR5834R
Tie Rod Axle Joint	1.4,1.6, TRENDLINE,HATCH & SEDAN	M/S	E	E	H	RE0185
Rack End	1.4,1.6, TRENDLINE,HATCH & SEDAN	M/S Short	E	E	H	RE5712
Tie Rod Axle Joint	1.4,1.6, TRENDLINE,HATCH & SEDAN	P/S Long	E	E	H	RE5870

POLO Mk V 6R,6C

01/2010 →

Rod/Strut, stabiliser	1.2,1.2TDI,1.2TSL,1.4,1.4GTI,1.4TSL,1.6,1.6TDI		E	E	H	CTR5605
Tie Rod End	1.2,1.2TDI,1.2TSL,1.4,1.4GTI,1.4TSL,1.6,1.6TDI		E	E		CTR5834L
Tie Rod End	1.2,1.2TDI,1.2TSL,1.4,1.4GTI,1.4TSL,1.6,1.6TDI		E		H	CTR5834R
Top Strut Mounting	1.2,1.2TDI,1.2TSL,1.4,1.4GTI,1.4TSL,1.6,1.6TDI		E	E	H	MO6180

						
CJ1090	CJ1091	CTR5605	CTR5706L	CTR5706R	CTR5834L	CTR5834R
Ref.Nr.: 6Q0407365M	Ref.Nr.: 6Q0407366M	Ref.Nr.: 6Q0411315E	Ref.Nr.: 1J0422811B	Ref.Nr.: 1J0422812B	Ref.Nr.: 6Q0423811A	Ref.Nr.: 6Q0423812
						
MO6180	RE0185	RE5712	RE5870			
Ref.Nr.: 1J0412331B	Ref.Nr.: 6X0422804A	Ref.Nr.: 6Q0423803PPA	Ref.Nr.: 6Q0423804EPA			

Article Description			Fitting Position	Article No.
---------------------	--	--	------------------	-------------

SCIROCCO (53)

02/1974 → 07/1980

Control Arm-/Trailing Arm Bush	1.1, 1.3, 1.5, 1.6		E	'E	'H	BS6911
Track Control Arm	1.1, 1.3, 1.5, 1.6	with rubber mounting, without ball joint	E	'E	'H	CJ108
Ball Joint	1.1, 1.3, 1.5, 1.6	ch.178-3-173 584→	E	'E	'H	CJ832
Tie Rod End	1.1, 1.3, 1.5, 1.6		E	'E	'H	CTR5140
Tie Rod Axle Joint	1.1, 1.3, 1.5, 1.6		E	'E	'H	RE033

SCIROCCO (53B)

08/1980 → 07/1992

Control Arm-/Trailing Arm Bush	1.3, 1.5, 1.6, 1.8, 1.8 16V		E	'E	'H	BS6911
Track Control Arm	1.3, 1.5, 1.6, 1.8, 1.8 16V	with rubber mounting, without ball joint	E	'E	'H	CJ108
Ball Joint	1.3, 1.5, 1.6, 1.8, 1.8 16V	ch.178-3-173 584→	E	'E	'H	CJ832
Tie Rod End	1.3, 1.5, 1.6, 1.8, 1.8 16V		E	'E	'H	CTR5140
Tie Rod Axle Joint	1.3, 1.5, 1.6, 1.8, 1.8 16V		E	'E	'H	RE033

SCIROCCO (137, 138)

05/2008 → 11/2009

Control Arm-/Trailing Arm Bush	1.4 TSI, 2.0 R, 2.0 TDI, 2.0 TSI	Material: Aluminium	E	'E		BS6883
Control Arm-/Trailing Arm Bush	1.4 TSI, 2.0 R, 2.0 TDI, 2.0 TSI	Material: Aluminium	E		'H	BS6884
Control Arm-/Trailing Arm Bush	1.4 TSI, 2.0 R, 2.0 TDI, 2.0 TSI	Rubber-metal Bearing	E	'E	'H	BS6899
Rod/Strut, stabiliser	1.4 TSI, 2.0 R, 2.0 TDI, 2.0 TSI	Material: Steel	E	'E	'H	CTR5849
Tie Rod Axle Joint	1.4 TSI, 2.0 R, 2.0 TDI, 2.0 TSI	for vehicles with electric power steering	E	'E	'H	RE5841

SHARAN (7N1, 7N2)

05/2010 → 05/2012

Control Arm-/Trailing Arm Bush	1.4 TSI, 2.0 TDI, 2.0 TDI 4motion, 2.0 TSI	Rubber-metal Bearing	E	'E	'H	BS6899
Tie Rod Axle Joint	1.4 TSI, 2.0 TDI, 2.0 TSI	for vehicles with electric power steering	E	'E	'H	RE5841

TIGUAN (5N_)

09/2007 → 08/2009

Control Arm-/Trailing Arm Bush	1.4 TSI, 1.4 TSI 4motion, 2.0 TDI, 2.0 TDI 4motion, 2.0 TFSI 4motion, 2.0 TSI 4motion	Rubber-metal Bearing	E	'E	'H	BS6899
Rod/Strut, stabiliser	1.4 TSI, 1.4 TSI 4motion, 2.0 TDI, 2.0 TDI 4motion, 2.0 TFSI 4motion	Material: Steel	E	'E	'H	CTR5849
Tie Rod Axle Joint	1.4 TSI, 1.4 TSI 4motion, 2.0 TDI, 2.0 TDI 4motion, 2.0 TFSI 4motion		E	'E	'H	RE5841

BS6883	BS6884	BS6899	BS6911	CJ108	CJ832	CTR5140
Ref.Nr.: 1K0199231J	Ref.Nr.: 1K0199232J	Ref.Nr.: 1K0407182	Ref.Nr.: 191407182	Ref.Nr.: 171407153D	Ref.Nr.: 171407365F	Ref.Nr.: 32111116463
CTR5849	RE033	RE5841				
Ref.Nr.: 1K0411315G	Ref.Nr.: 171419821	Ref.Nr.: 1K0423810A				

Article Description			Fitting Position	Article No.
---------------------	---	---	------------------	-------------

TOURAN (1T1, 1T2)

02/2003 → 05/2010

Control Arm-/Trailing Arm Bush	1.4FSI, 1.4TSI, 1.4TSIEcoFuel, 1.6, 1.6FSI, 1.9TDI, 2.0 EcoFuel, 2.0 FSI, 2.0 TDI, 2.0 TDI 16V	Material: Aluminium	E	'E		BS6883
Control Arm-/Trailing Arm Bush	1.4FSI, 1.4TSI, 1.4TSIEcoFuel, 1.6, 1.6FSI, 1.9TDI, 2.0 EcoFuel, 2.0 FSI, 2.0 TDI, 2.0 TDI 16V	Material: Aluminium	E		'H	BS6884
Control Arm-/Trailing Arm Bush	1.4FSI, 1.4TSI, 1.4TSIEcoFuel, 1.6, 1.6FSI, 1.9TDI, 2.0 EcoFuel, 2.0 FSI, 2.0 TDI, 2.0 TDI 16V	Rubber-metal Bearing	E	'E	'H	BS6899
Rod/Strut, stabiliser	1.4FSI, 1.4TSI, 1.4TSIEcoFuel, 1.6, 1.6FSI, 1.9TDI, 2.0 EcoFuel, 2.0 FSI, 2.0 TDI, 2.0 TDI 16V	Material: Steel	E	'E	'H	CTR5849
Rod/Strut, stabiliser	1.9 TDI	Engine Code: BRU; Material: Steel	E	'E	'H	CTR5849
Tie Rod Axle Joint	1.4FSI, 1.4TSI, 1.4TSIEcoFuel, 1.6, 1.6FSI, 1.9TDI, 2.0 EcoFuel, 2.0 FSI, 2.0 TDI, 2.0 TDI 16V		E	'E	'H	RE5841

TOURAN (1T3)

05/2010 → 05/2015

Control Arm-/Trailing Arm Bush	1.2 TSI, 1.4 TSI, 1.4 TSI EcoFuel, 1.6 TDI, 2.0 TDI	Rubber-metal Bearing	E	'E	'H	BS6899
Rod/Strut, stabiliser	1.2 TSI, 1.6 TDI, 2.0 TDI	Material: Steel	E	'E	'H	CTR5849
Tie Rod Axle Joint	1.2 TSI, 1.4 TSI, 1.4 TSI EcoFuel, 1.6 TDI, 2.0 TDI	for vehicles with electric power steering	E	'E	'H	RE5841

TRANSPORTER / CARAVELLE Mk III Bus

05/1979 → 07/1992

Tie Rod End	1.6, 1.6D, 1.6TD, 1.6TD Syncro, 1.7D, 1.9, 1.9 Syncro, 2.0, 2.1, 2.1 i, 2.1 Syncro		E	'E	'H	CTR5140
-------------	--	--	---	----	----	---------

TRANSPORTER Mk III Box

05/1979 → 07/1992

Tie Rod End	1.6, 1.6D, 1.6TD, 1.6TD Syncro, 1.7D, 1.9, 1.9 Syncro, 2.0, 2.1, 2.1 i, 2.1 Syncro		E	'E	'H	CTR5140
-------------	--	--	---	----	----	---------

TRANSPORTER Mk III Platform/Chassis

05/1979 → 07/1992

Tie Rod End	1.6TD, 1.6TDSyncro, 1.7D, 1.9, 1.9 Syncro, 2.0, 2.1, 2.1 i, 2.1 Syncro		E	'E	'H	CTR5140
-------------	--	--	---	----	----	---------

TRANSPORTER / CARAVELLE Mk IV Bus (70XB, 70XC, 7DB, 7DW, 7DK)

09/1990 → 04/2003

Tie Rod Axle Joint	1.9 D, 1.9 TD, 2.0, 2.4 D, 2.5, 2.5 TDI, 2.8 VR 6	ch.70-T-200001 →; 01/1996 →; with rubber grommet; for vehicles with power steering	E	'E	'H	RE5718
Tie Rod Axle Joint	2.4 D [AJA], 2.5 [AET, APL, AVT], 2.5 Syncro [AET, APL, AVT], 2.5 TDI, 2.5 TDI Syncro, 2.8 Syncro, 2.8 V6	with rubber grommet; for vehicles with power steering	E	'E	'H	RE5718
Tie Rod Axle Joint	2.4 D Syncro, 2.5 Syncro	ch.70-T-200000 →; 01/1996 →; with rubber grommet; for vehicles with power steering	E	'E	'H	RE5718

						
BS6883	BS6884	BS6899	CTR5140	CTR5849	RE5718	RE5841
Ref.Nr.: 1K0199231J	Ref.Nr.: 1K0199232J	Ref.Nr.: 1K0407182	Ref.Nr.: 32111116463	Ref.Nr.: 1K0411315G	Ref.Nr.: 701419810B	Ref.Nr.: 1K0423810A

Article Description			Fitting Position	Article No.
---------------------	--	--	------------------	-------------

TRANSPORTER Mk IV Box (70XA)

07/1990 → 04/2003

Tie Rod Axle Joint	1.9 D, 1.9 TD, 2.0, 2.4 D, 2.5, 2.5 TDI, 2.8 VR 6	ch.70-T-200001→; 01/1996 →; with rubber grommet; for vehicles with power steering	E	'E	'H	RE5718
Tie Rod Axle Joint	2.4 D [AJA], 2.5 [AET,APL,AVT], 2.5 Syncro [AET,APL,AVT], 2.5 TDI, 2.5 TDI Syncro, 2.8 Syncro, 2.8 V6	with rubber grommet; for vehicles with power steering	E	'E	'H	RE5718
Tie Rod Axle Joint	2.4 D Syncro, 2.5 Syncro	ch.70-T-200000→; 01/1996 →; with rubber grommet; for vehicles with power steering	E	'E	'H	RE5718

TRANSPORTER Mk IV Platform/Chassis (70XD)

07/1990 → 04/2003

Tie Rod Axle Joint	1.9 D, 1.9 TD, 2.0, 2.4 D, 2.5, 2.5 TDI, 2.8 VR 6	ch.70-T-200001→; 01/1996 →; with rubber grommet; for vehicles with power steering	E	'E	'H	RE5718
Tie Rod Axle Joint	2.4 D [AJA], 2.5 [AET,APL,AVT], 2.5 Syncro [AET,APL,AVT], 2.5 TDI, 2.5 TDI Syncro, 2.8 Syncro, 2.8 V6	with rubber grommet; for vehicles with power steering	E	'E	'H	RE5718
Tie Rod Axle Joint	2.4 D Syncro, 2.5 Syncro	ch.70-T-200000→; 01/1996 →; with rubber grommet; for vehicles with power steering	E	'E	'H	RE5718

MULTIVAN Mk V (7HM, 7HN, 7HF, 7EF, 7EM, 7EN)

04/2003 → 11/2009

Control Arm-/Trailing Arm Bush	1.9 TDI, 2.0, 2.5 TDI, 3.2 V6	Rubber-metal Bearing	E	'E	'H	BS8271
Control Arm-/Trailing Arm Bush	1.9 TDI, 2.0, 2.0 BiTDI, 2.0 BiTDI 4motion, 2.0 TDI, 2.0 TDI 4motion, 2.0 TSI, 2.0 TSI 4motion, 2.5 TDI, 2.5 TDI 4motion, 3.2 4motion, 3.2 V6, 3.2 V6 4motion	Rubber-metal Bearing	E	'E	'H	BS8272
Ball Joint	1.9 TDI, 2.0, 2.0 BiTDI, 2.0 BiTDI 4motion, 2.0 TDI, 2.0 TDI 4motion, 2.0 TSI, 2.0 TSI 4motion, 2.5 TDI, 2.5 TDI 4motion, 3.2 4motion, 3.2 V6, 3.2 V6 4motion		E	'E	'H	CJ1163

TRANSPORTER / CARAVELLE Mk V Bus (7HB, 7HJ, 7EB, 7EJ, 7EF, 7...)

04/2003 → 11/2009

Control Arm-/Trailing Arm Bush	1.9 TDI, 2.0, 2.0 TDI, 2.0 TSI, 2.0 TSI 4motion, 2.5 TDI, 2.5 TDI 4motion, 3.2 4motion, 3.2 V6, 3.2 V6 4motion	Rubber-metal Bearing	E	'E	'H	BS8272
Ball Joint	1.9 TDI, 2.0, 2.0 TDI, 2.0 TSI, 2.0 TSI 4motion, 2.5 TDI, 2.5 TDI 4motion, 3.2 4motion, 3.2 V6, 3.2 V6 4motion	Gross Vehicle Weight [kg]: 2600, 2800, 2850, 3000	E	'E	'H	CJ1163

TRANSPORTER Mk V Box (7HA, 7HH, 7EA, 7EH)

04/2003 → 11/2009

Control Arm-/Trailing Arm Bush	1.9 TDI, 2.0, 2.0 TDI, 2.0 TDI 4motion, 2.0 TSI, 2.0 TSI 4motion, 2.5 TDI, 2.5 TDI 4motion, 3.2 4motion, 3.2 V6	Rubber-metal Bearing	E	'E	'H	BS8272
Ball Joint	1.9 TDI, 2.0, 2.0 TDI, 2.0 TDI 4motion, 2.0 TSI, 2.0 TSI 4motion, 2.5 TDI, 2.5 TDI 4motion, 3.2 4motion, 3.2 V6	Gross Vehicle Weight [kg]: 2600, 2800, 2850, 3000	E	'E	'H	CJ1163

TRANSPORTER Mk V Platform/Chassis (7JD, 7JE, 7JL, 7JY, 7JZ)

04/2003 → 11/2009

Control Arm-/Trailing Arm Bush	1.9 TDI, 2.0, 2.0 TDI, 2.0 TDI 4motion, 2.0 TSI, 2.5 TDI, 2.5 TDI 4motion, 3.2 V6	Rubber-metal Bearing	E	'E	'H	BS8272
Ball Joint	1.9 TDI, 2.0, 2.0 TDI, 2.0 TDI 4motion, 2.0 TSI, 2.5 TDI, 2.5 TDI 4motion, 3.2 V6	for vehicles with double-cab	E	'E	'H	CJ1163

UP

08/2011 →

Control Arm-/Trailing Arm Bush	1.0		E	'E	'H	BS6417
Control Arm-/Trailing Arm Bush	1.0		E	'E	'H	BS6911
Rod/Strut, stabiliser	1.0, 1.0 EcoFuel, e-Up	Material: Steel	E	'E	'H	CTR5605
Top Strut Mounting	1.0, 1.0 EcoFuel	without ball bearing	E	'E	'H	MO6180

BS6417	BS6911	BS8271	BS8272	CJ1163	CTR5605	MO6180
Ref.Nr.: 1J0407181	Ref.Nr.: 191407182	Ref.Nr.: 7H0407182A	Ref.Nr.: 2H0407183A	Ref.Nr.: 7H0407361A	Ref.Nr.: 6Q0411315E	Ref.Nr.: 1J0412331B
RE5718						
Ref.Nr.: 701419810B						

ORIGINAL-NO.

AUDI		AUDI		AUDI		BMW	
171419821	RE033	4D0407510K	CJ1035	8E0407505A	CJ287	31124004360	BS7205
191407182	BS6911	4D0407515	BS7072	8E0407693E	CJ292	31124028607	CJ1152
191422803APART	RE5473	4D0407515C	BS7072	8E0407694E	CJ293	31124028608	CJ1151
1J0407181	BS6417	4D0407693AC	CJ292	8E0419811B	CTR5491	31124036269	CJ1149
1J0407365A	CJ986	4D0407693AD	CJ292	8Z0411315D	CTR5605	31124036270	CJ1150
1J0407365C	CJ986	4D0407693E	CJ292	BMW		31126750057S1	BS7205
1J0407365D	CJ986	4D0407693H	CJ292	31111096982	BS7205	31126750221	BS7205
1J0407365H	CJ986	4D0407693K	CJ292	31121092023	CJ1065L	31126750222	BS7205
1J0407365J	CJ986	4D0407693M	CJ292	31121092024	CJ1065R	31126750223	CJ143
1J0407366A	CJ987	4D0407693N	CJ292	31121093449	CJ1066L	31126750224	CJ142
1J0407366C	CJ987	4D0407694AC	CJ293	31121093450	CJ1066L	31126751317	CJ143
1J0407366D	CJ987	4D0407694AD	CJ293	31121093450	CJ1066R	31126751318	CJ142
1J0407366H	CJ987	4D0407694E	CJ293	31121094233	CJ1066L	31126751372	BS7205
1J0407366J	CJ987	4D0407694H	CJ293	31121094234	CJ1066R	31126751435	BS7205
1J0412331	MO6180	4D0407694K	CJ293	31121094275	CJ870L	31126751436	BS7205
1J0412331B	MO6180	4D0407694M	CJ293	31121094276	CJ870R	31126752717	CJ143
1J0412331C	MO6180	4D0407694N	CJ293	31121094465	CJ143	31126752718	CJ142
1J0422807B	RE8143	4D0419811A	CTR5491	31121094466	CJ142	31126753058	BS7205
1J0422811B	CTR5706L	4D0419811B	CTR5491	31121095277	BS7205	31126753059	BS7205
1J0422812B	CTR5706R	4D0419811G	CTR5491	31121095278	BS7205	31126753060	BS7205
1K0199231G	BS6883	4D0419811H	CTR5491	31121096685	CJ863	31126754547	BS7205
1K0199231J	BS6883	4F0419811E	CTR5491	31121096983	BS7205	31126754899	BS7205
1K0199232G	BS6884	4F0498811	CTR5491	31121096984	BS7205	31126754900	BS7205
1K0199232J	BS6884	6Q0411315A	CTR5605	31121096985	CJ143	31126757623	BS7205
1K0407182	BS6899	6Q0411315B	CTR5605	31121096986	CJ142	31126758510	CJ863
1K0407182A	BS6899	6Q0411315C	CTR5605	31121126253	CJ848	31126758513	CJ870L
1K0411315B	CTR5849	6Q0411315D	CTR5605	31121126254	CJ847	31126758514	CJ870R
1K0411315D	CTR5849	6Q0411315E	CTR5605	31121126296	CJ848	31126758515	CJ870L
1K0411315G	CTR5849	6Q0411315F	CTR5605	31121130123	BS5422	31126758516	CJ870R
1K0411315J	CTR5849	6Q0411315G	CTR5605	31121130140	BS5422	31126758519	CJ143
1K0411315K	CTR5849	6Q0411315H	CTR5605	31121133710	BS6177	31126758520	CJ142
1K0411315N	CTR5849	6Q0411315J	CTR5605	31121136529	CJ870L	31126760181	CJ1152
1K0411315P	CTR5849	6Q0411315L	CTR5605	31121136530	CJ870R	31126760182	CJ1151
1K0411315R	CTR5849	6Q0411315M	CTR5605	31121139131	CJ848	31126763703	CJ1149
1K0423810A	RE5841	6Q0411315N	CTR5605	31121140398	CJ863	31126763704	CJ1150
357407182	BS6911	6Q0411315P	CTR5605	31121140399	CJ870L	31126763707	CJ1149
4B0419811	CTR5491	6R0411315	CTR5605	31121140400	CJ870R	31126763708	CJ1150
4B0419811B	CTR5491	6R0411315A	CTR5605	31121140957	CJ870L	31126768297	CJ1152
4B0419811C	CTR5491	8D0407505B	CJ287	31121140958	CJ870R	31126768298	CJ1151
4B0419811D	CTR5491	8D0407505F	CJ287	31121141717	CJ1065L	31126769797	CJ1149
4B0419811E	CTR5491	8D0407505H	CJ287	31121141718	CJ1065R	31126769798	CJ1150
4B0419811F	CTR5491	8D0407505K	CJ287	31122347951	CJ1152	31126769801	CJ1149
4D0407183D	BS7069	8D0407506B	CJ1033	31122347952	CJ1151	31126769802	CJ1150
4D0407183M	BS7069	8D0407506F	CJ1033	31122347963	CJ1152	31126770247	CJ143
4D0407183N	BS7069	8D0407506H	CJ1033	31122347965	CJ1151	31126770248	CJ142
4D0407183P	BS7069	8D0407506K	CJ1033	31122405861	CJ1149	31126774819	CJ143
4D0407183Q	BS7069	8E0407151E	CJ1175	31122405862	CJ1150	31126774820	CJ142
4D0407509B	CJ1034	8E0407151K	CJ1175	31122409598	CJ1150	31126777851	CJ143
4D0407509D	CJ1034	8E0407151L	CJ1175	31122409599	CJ1149	31126777852	CJ142
4D0407509K	CJ1034	8E0407151M	CJ1175	31124000612	BS7205	31129058931	BS5422
4D0407510B	CJ1035	8E0407151N	CJ1175	31124004359	BS7204	31129059288	BS5421
4D0407510D	CJ1035	8E0407151R	CJ1175	31124004359	BS7205	31129071663	BS7205

ORIGINAL-NO.

BMW

31129071952	BS7205
31129071963	BS7205
31351091764	CTR5159
31351095694	CTR5605
31351124380	CTR5380
31351127194	CTR5380
31351127689	CTR5159
31351128050	CTR5380
31351128737	CTR5159
31351130075	CTR5380
31351134582	CTR5380
31352227203	CTR5380
31356765933	CTR5875L
31356765934	CTR5875R
31356780847	CTR5605
32106774347PART	RE5845
32106777479PART	RE5845
32111091767*	RE5549
32111091767PART	RE5549
32111091768*	RE5549
32111091768PART	RE5549
32111096897PART	RE5604
32111127124	RE5472
32111130449	RE5472
32111139315PART	RE046
32111139316PART	RE046
32111139318PART	RE5489
32216762243	RE5843
32216762244	RE5843
32216762403PART	RE5845

CHEVROLET

26011925	CTR5506
26059294	CTR5170
26087868	CTR5506
90141393	CJ951
90295479	CJ951
90297863	CJ951
90487561	CJ1089
90496116	CTR5771
90512982	CJ1089
90542995	CJ1089
9118127	CTR5170
93186537	CTR5170
93192419	CTR5506
96391875	CTR5891
96535081	CJ269L
96535082	CJ269R
96535088	BS8315
96653381	BS8315
96815893	CJ269L
96815894	CJ269R
96870465	CJ269L

CHEVROLET

96870466	CJ269R
----------	--------

CHRYSLER

04797706	CTR6107
4797706	CTR6107
5099237AA	CJ1028
68020843AA	RE5928
68020845AA	CTR5927
68047089AA	CTR5927

CITROËN

508750	CTR6130
--------	---------

DAEWOO

1603302	CJ869
96129753	CTR5141
96205809	CTR5141
96275798	CTR5891
96391875	CTR5891
96446586	CTR5141
96535081	CJ269L
96535082	CJ269R
96535088	BS8315
96653381	BS8315
96815893	CJ269L
96815894	CJ269R
96870465	CJ269L
96870466	CJ269R
D96205809	CTR5141
D96275798	CTR5891
D96391875	CTR5891

FIAT

05958246	CTR5401
05960254	MO5809
46543045	CJ1045
5958246	CTR5401
5958247	CTR5401
5960254	MO5809
5983404	CTR5401
5983406	CTR5401
SE127162410A	CTR5401

FORD

1003574	CJ159R
1003575	CJ159R
1003584	CJ159L
1003585	CJ159L
1004011	BS7411
1004018	CTR5318
1009580	CJ159R
1009584	CJ159R
1009594	CJ159L
1009596	CJ159L
1010037	BS6496
1014654	BS7411
1015260	CJ159R

FORD

1015264	CJ159L
1017013	CJ159R
1017014	CJ159L
1021219	CJ159R
1021220	CJ159L
1030025	CJ582
1030026	CJ582
1045655	CJ159R
1045656	CJ159L
1046280	CJ159R
1046282	CJ159L
1046283	CJ159R
1046285	CJ159L
1047797	CJ582
1047798	CJ582
1055191	BS6496
1058279	CJ124
1058280	CJ125
1061631	CTR5318
1063236	CJ159R
1063255	CJ159L
1063372	BS7411
1067818	CTR5318
1130273	CTR5318
1135077	CTR5318
1146150	CTR6172
1223792	CTR5923
1230909	CTR5923
1310333	CTR6191
1315074	CTR5921R
1315083	CTR5921L
1335548	CTR6191
1454896	CTR5308
1469208	CTR6191
1469212	CTR6172
1470387	CJ1259
1513343	CTR1418
1545457	RE6092
1637182	CJ964
1637183	CJ964
1637184	CJ965
1637185	CJ965
1661237	CTR5318
1679388	CJ1259
1745924	CTR1418
1761200	CTR6172
1790310	CTR1418
1905043	CTR1418
1E0034153A	BS6496
1E0034170	CTR5318
1E0134153A	BS7411
1S613B438AA	CTR5318

FORD

2S613B438AC	CTR6172
2S613B438AD	CTR6172
2S613B438AE	CTR6172
3240196	CJ843
3240197	CJ844
3246129	CJ844
3246130	CJ843
3669093	CTR5335
3M513B438AB	CTR5923
3M513K209BA	CJ1259
4342539	RE5571
5021456	CJ843
5021457	CJ844
5021458	CJ964
5021459	CJ965
6084942	CJ843
6084943	CJ844
6087888	CJ843
6087889	CJ844
6115333	CJ843
6115334	CJ843
6115335	CJ844
6115336	CJ844
6131083	RE5407
6134277	RE5407
6135757	RE5450
6185335	RE5407
6185336	RE5407
6185338	RE5450
6186082	CTR5318
6188004	CTR5318
6198621	CTR5318
6525743	CJ124
6525843	CJ124
6525844	CJ125
6615742	CJ124
6615743	CJ125
6732630	CJ124
6732631	CJ125
6770224	CJ124
6770225	CJ125
6829045	CJ1259
7102644	CJ124
7102645	CJ125
7152281	CJ582
7351747	CJ124
7351748	CJ125
81AB3A052AC	CJ843
81AB3A053AC	CJ844
83BB3L519EA	RE5407
86AB3078A2A	CJ843
86AB3079A1A	CJ965

ORIGINAL-NO.

FORD

86AB3079A2A	CJ965
87BB3L519DA	RE5407
87BB3L519EA	RE5407
87GB3L519BA	RE5450
880X3B376CA	CJ964
89FB3B438A1E	CTR5318
8AU334510	CJ983
8V513B438AB	CTR1418
8V513B438BA	CTR1418
8V513B438BB	CTR1418
8V513B438BC	CTR1418
8V513L519AA	RE6092
91AB3042AB	CJ124
91AB3042AD	CJ124
91AB3051AD	CJ125
92AB3042AA	CJ124
92AB3042BA	CJ124
92AB3051AA	CJ125
92AB3051BA	CJ125
93BB5K653AB	CJ1259
94AB3042AA	CJ124
94AB3051AA	CJ125
94FB3395A2A	CJ582
94FB3395A2B	CJ582
94FB3B376AA	CJ582
95AB3042AB	CJ124
95AB3042AE	CJ124
95AB3051AB	CJ125
95AB3051AD	CJ125
95AB3051AE	CJ125
96FB3042BF	CJ159R
96FB3042BG	CJ159R
96FB3051BF	CJ159L
96FB3051BG	CJ159L
96FB3063AA	BS6496
96FB3063AB	BS6496
96FB3A262AD	BS7411
96FB3B438AB	CTR5318
98AG3B438AB	CTR5318
98FB3042CC	CJ159R
98FB3051CC	CJ159L
98FB3063AA	BS6496
98FB3A262AA	BS7411
K9597	CJ919
ME4M5J3395AA	CJ1259
UR5632250	CTR5984
UR6134550	CJ1205
XM343289BA	CTR5335
YS413B438BA	CTR5318

FOTON

4504629325	CTR5005A
4550329565	RE188

GONOW

4333039165	CJ934
4335039035	CJ933

GWM

4333039165	CJ934
4335039035	CJ933

HOLDEN

90141393	CJ951
90295479	CJ951
90297863	CJ951
90487561	CJ1089
90496116	CTR5771
90512982	CJ1089
90542995	CJ1089

HONDA

51220SA0A01	CJ962
51220SB0003	CJ962
51220SE0000	CJ962
51220SE0003	CJ962
51220SF1000	CJ962
51220SF1100	CJ962
51220SH3003	CJ962
51220SK7003	CJ962
51220SK7013	CJ962
51220SM0A01	CJ962
51320S04003	CTR5552
51450S01023	CJ610R
51460S01023	CJ610L
53010S04000	RE5908
53010SR3010	RE071
53540SH3003	CTR5345R
53540SH3013	CTR5345R
53560SH3003	CTR5345L
53560SH3013	CTR5345L

HYUNDAI

5450322A00	CJ1011
5450331600	CJ1011
5452031600	CJ1011
5453014200	CJ1011
5453031600	CJ1011
545842E000	BS7860
548301C000	CTR5915L
5483029000	CTR6032
548401C000	CTR5915R
5553029000	CTR3107
5553029500	CTR3107
5553029500AS	CTR3107
5682025000	CTR5474
5682028520	CTR5474
5682037010	CTR5474
568203B000	CTR5567
5685028520	CTR5474
577240X000	RE6055

ISUZU

324057	CTR5331R
8944194080	CTR5331R
8944194081	CTR5331R
8944194090	CTR5331L
8944194091	CTR5331L
89444594642	CJ936
8944521020	CJ946
8944521021	CJ946
8944594532	CJ930
8944594533	CJ930
8944594534	CJ930
8944594641	CJ936
8944594642	CJ936
8944594651	CJ946
8944594652	CJ946
8944594800	CTR5331R
8944594802	CTR5331R
8944594810	CTR5331L
8944594812	CTR5331L
897304855051	CTR5806
8979445680	CTR6182R
8979445690	CTR6182L
898005827051	CJ1221
920373	CTR5331R
94419408	CTR5331R
94452102	CJ946
94459464	CJ936
94459480	CTR5331R

KIA

545842E000	BS7860
------------	--------

MAZDA

1010037	BS6496
1014654	BS7411
1055191	BS6496
1063372	BS7411
1130273	CTR5318
1335548	CTR6191
1E0034153A	BS6496
1E0034170	CTR5318
1E0034300A	CJ159R
1E0034350A	CJ159L
1E0134153A	BS7411
1E0134300A	CJ159R
1E0134350A	CJ159L
6M343280AA	CTR5308
8AB032280	CTR5184
8AB232280	CTR5184
8AU132280	CTR5335
8AU334510	CJ983
94FB3395A2B	CJ582
B00134550	CJ926
B09232240	RE014

MAZDA

B09234550	CJ926
B32H34300	CJ294R
B32H34300A	CJ294R
B32H34300B	CJ294R
B32H34300C	CJ294R
B32H34300D	CJ294R
B32H34300E	CJ294R
B32H34350	CJ294L
B32H34350A	CJ294L
B32H34350B	CJ294L
B32H34350C	CJ294L
B32H34350D	CJ294L
B32H34350E	CJ294L
B37F34300	CJ294R
B37F34300A	CJ294R
B37F34300B	CJ294R
B37F34350	CJ294L
B37F34350A	CJ294L
B37F34350B	CJ294L
B45532280	CTR5184
BF6232240	RE014
BF6732240	RE014
BF673224X	RE014
BP4K28170C	CTR6191
BP4K28170D	CTR6191
BP4K34170C	CTR5923
BP4K34300	CJ294R
BP4K34300A	CJ294R
BP4K34300B	CJ294R
BP4K34300C	CJ294R
BP4K34300D	CJ294R
BP4K34300E	CJ294R
BP4K34350	CJ294L
BP4K34350A	CJ294L
BP4K34350B	CJ294L
BP4K34350C	CJ294L
BP4K34350D	CJ294L
BP4K34350E	CJ294L
BP4L32240	RE5946
C51334300	CJ294R
C51334350	CJ294L
CC3034300	CJ294R
CC3034300A	CJ294R
CC3034300B	CJ294R
CC3034300C	CJ294R
CC3034300D	CJ294R
CC3034300E	CJ294R
CC3034350	CJ294L
CC3034350A	CJ294L
CC3034350B	CJ294L
CC3034350C	CJ294L
CC3034350D	CJ294L

ORIGINAL-NO.

ORIGINAL-NO.

MAZDA

CC3034350E	CJ294L
D65132240	RE6092
D65134170	CTR1418
D65134170A	CTR1418
DD3234170	CTR6172
DD3234170A	CTR6172
DD3234170B	CTR6172
GJ6A32240	RE5948
GJ6A34300B	CJ1199
GJ6A34300C	CJ1199
GJ6A34300D	CJ1199
K9597	CJ919
LC6234170	CTR5527
LC6234170B	CTR5527
UH7432280	CTR5335
UR5632250	CTR5984
UR6134550	CJ1205

MERCEDES-BENZ

0013307435	CTR5497
0013307735	CTR5497
1233380210	CTR5172
1693330127	CJ1143
2023330027	CJ1028
2033200489	CTR5783
2033202589	CTR5783
2033202889	CTR5783
2033300111	CJ997L
2033300211	CJ997R
2033301611	CJ997L
2033301711	CJ997R
2033301903	CTR5781L
2033301911	CJ996L
2033302011	CJ996R
2033303311	CJ996L
2033303411	CJ996R
2033303511	CJ997L
2033303611	CJ997R
2033303903	CTR5781L
2033303911	CJ997L
2033304011	CJ997R
2043201889	CTR6047R
2043301911	CJ996L
2043302011	CJ996R
2043304311	CJ997L
2043304411	CJ997R
2103300035	CJ1028
2103330427	CJ1028
2103380415	RE5444
2113300235	CJ1193
2113300335	CJ1028
2113300435	CJ1193
2203300635	CJ1028

MERCEDES-BENZ

2203330127	CJ1193
2203330227	CJ1193
2203330327	CJ1193
2203330427	CJ1193
2203330727	CJ1193
2203380715	RE5782
2303380015	RE5782
9014600048	CTR5542
9014600148	CTR5542
9014600248	CTR5542
9014600348	CTR5542
90610481001	CTR5927
90610481003	CTR5927
90610551003	RE5928
9064600048	CTR5927
9064600055	RE5928
9064600148	CTR5927
9064600348	CTR5927

MINI

31351130075	CTR5380
31351134582	CTR5380

MITSUBISHI

MB831037	CJ961L
MB831038	CJ961R
MB831043	CTR5557
MB831044	CTR5556
MB860829	CJ904
MB860830	CJ904
MR296269	CJ961L
MR296270	CJ961R

NISSAN

4016001G00	CJ912
4016001G25	CJ912
4016001G50	CJ912
4016001G90	CJ912
4016001N25	CJ912
40160B1001	CJ787
485200W025	CTR5700
48520H1001	CTR1367R
4852101G25	CTR5310
485212S425	CTR5601
4852131G25	CTR5309
485213U025	RE5990
4852150400	RE053
4852150Y00	RE053
48521H1001	CTR1366R
48521H5025	CTR1366R
48521W5025	CTR1366R
4857031G25	CTR5309
485703S500	CTR5699
48640H1001	CTR1367L
48641H1001	CTR1366L

NISSAN

48641H5025	CTR1366L
48641W5025	CTR1366L
54500AX600	BS8147
54500AX600	BS8218
54500BC41A	BS8147
54500BC42A	BS8147
54501AX600	BS8147
54501AX600	BS8218
54501BC41A	BS8147
54501BC42A	BS8147
54560AX600	BS8147
54560AX600	BS8218
54570AX600	BS8218
5461600QAA	BS8131
546184M400	CTR5682
5461850Y00	CTR5559
5461858820	CTR5559
546188H300	CTR5675R
54618AX600	CTR5770
54618D5000	CTR5559
54618D5010	CTR5559
54618EA010	CTR6150R
54618EB30A	CTR6150R
546688H300	CTR5675L
54668EA010	CTR6150L
54668EB30A	CTR6150L
D8520VK91A	CTR5600

OPEL

025260037576	CJ869
0322158	RE5815
0324053	CTR5427L
0324054	CTR5427R
0324055	CTR5427L
0324056	CTR5427R
0344523	MO6848
0352074	CJ1501L
0352075	CJ1501L
0352076	CJ1501R
0352077	CJ1501L
0352143	CJ1501L
0352163	CJ1501L
0352192	CJ1501R
0352193	CJ1501L
0352300	BS6406
0352346	BS6406
0352347	BS6383
0352348	BS6383
0352351	BS6406
0352352	BS6383
0352822	CJ946
0352828	CJ946
0920373	CTR5331R

OPEL

0920374	CTR5331L
1603008	RE5499
1603009	CTR5506
1603018	RE056
1603121	CJ951
1603163	CJ951
1603167	CJ951
1603202	CJ869
1603213	RE5547
1603214	CTR5170
1603215	CTR5170
1603216	RE5547
1603287	RE5547
1603302	CJ869
1603303	RE5547
1603455	CTR5500
1603542	CTR5170
1603645	CTR5506
1603843	RE056
1603845	RE5499
310821	CJ930
322158	RE5815
324050	CTR5506
324053	CTR5427L
324054	CTR5427R
324055	CTR5427L
324056	CTR5427R
324066	CTR5500
344523	MO6848
350263	CTR5643
350610	CTR5771
350611	CTR2462
350614	CTR2462
352074	CJ1501L
352075	CJ1501L
352076	CJ1501R
352077	CJ1501L
352143	CJ1501L
352163	CJ1501L
352192	CJ1501R
352193	CJ1501L
352300	BS6406
352309	BS6102
352310	BS6103
352320	BS6103
352346	BS6406
352347	BS6383
352348	BS6383
352351	BS6406
352352	BS6383
352800	CJ1089
352803	CJ654

ORIGINAL-NO.

OPEL		RENAULT		TOYOTA		TOYOTA	
352822	CJ946	7701474448	RE5902		CJ1168L	4504639106	CTR5300
352828	CJ946	7701474492	CTR5726L		CJ1168R	4504639125	CTR5300
352829	CJ1089	7701474493	CTR5726R		CJ1169	4504639165	CTR5300
352830	CJ1089	7701475842	CTR5726L		CJ1170L	4504639175	CTR5300
5352000	CJ1501R	7701475843	CTR5726R		CJ1170R	4504639215	CTR5300
5352001	CJ1501L	7701476760	CTR5726L		CJ1188	4504639235	CTR5300
5352015	CJ1501L	7701476761	CTR5726R	4333009070	CJ949	4504639355	CTR5300
8944594652	CJ946	7701476762	CTR5726L	4333009090	CJ949	4504639375	CTR5300
90268463	BS6383	7701476763	CTR5726R	4333009230	CJ949	4504639385	CTR5300
90288082	BS6383	8200041166	BS6819	4333009295	CJ1187	4504649115	CTR5470R
90288232	BS6406	8200127308	CTR5770	4333009490	CJ1187	4504660081	CTR5005
90373778	BS6406	8200183569	BS8147	4333009510	CJ1187	4504669055	CTR5005
90373779	CJ1501L	8200183570	BS8218	4333009640	CJ949	4540629115	CTR5301
90468554	MO6848	8200298454PART	CJ1145	4333019065	CJ915	4540629145	CTR5317
90473226	CJ1501L	8200298455PART	CJ1145	4333019066	CJ915	4540629175	CTR5317
90473227	CJ1501R	8200346941	BS8147	4333019115	CJ949	4550002130	RE5957
90495103	CJ1501L	8200346941	BS8218	4333029125	CJ931	4550002300	RE5957
90495104	CJ1501R	8200346941	CJ1145	4333029135	CJ935	4550312130	RE2406
90495159	CJ1501L	8200346941	CJ299L	4333029136	CJ935	4550319116	RE049
90495160	CJ1501R	8200346942	BS8147	4333029137	CJ935	4550319125	RE030
90539896	CJ869	8200346942	BS8218	4333029138	CJ935	4550319215	RE5463
920373	CTR5331R	8200346942	CJ1145	4333029139	CJ935	4550329255	RE049
920374	CTR5331L	8200346942	CJ299R	4333029140	CJ935	4550329565	RE188
94459465	CJ946	8200457209	CJ1145	4333029175	CJ281	4550329565	RE188
94459481	CTR5331L	8200615057	CJ1145	4333029205	CJ935	4550349105	RE5975
PEUGEOT		8200615057	CJ299L	4333039165	CJ934	4551012390	RE5957
3812C5	RE5651	8200615058	CJ1145	4333049045	CJ949	4806802020	CJ266R
508750	CTR6130	8200615058	CJ299R	4333069015	CJ949	4806802021	CJ266R
96347856	CTR6130	8200679067	CJ1145	4334019015	CJ914	4806802030	CJ266R
PORSCHE		8200696437	BS8218	4334019016	CJ914	4806802070	CJ266R
171407153D	CJ108	8200744091	CJ1145	4334029105	CJ931	4806802080	CJ266R
171407181APART	CJ108	8200744091	CJ299L	4335029045	CJ932	4806812220	CJ266R
171407182DPART	CJ108	8200744092	CJ1145	4335029056	CJ932	4806812260	CJ266R
171407365F	CJ832	8200744092	CJ299R	4335029065	CJ984	4806813010	CJ266R
171407365G	CJ832	SAAB		4335029095	CJ984	4806902020	CJ266L
171419811	CTR5140	30540743	CTR5643	4335039035	CJ933	4806902021	CJ266L
RENAULT		4242749	CTR5427L	4335039045	CJ981	4806902030	CJ266L
6001547606	RE5986	4242756	CTR5427R	4336029065	CJ932	4806902070	CJ266L
6001547610	CTR5985L	4400040	CTR5643	4336029076	CJ932	4806902080	CJ266L
6001547611	CTR5985R	4544599	CTR5643	4336039085	CJ981	4806912220	CJ266L
6001550441	RE5986	4686606	CTR5771	4504609020	CTR5429L	4806912260	CJ266L
6001550442	CTR5985L	4835740	CJ1089	4504609360	CTR5470R	4806913010	CJ266L
6001550443	CTR5985R	5231683	CJ1089	4504619175	CTR5343A	4865507010	BS8424
7700418941	BS6002	5236823	CTR5771	4504619265	CTR5470R	4865512120	BS6455
7700419236	BS6002	93185278	CJ1089	4504629115	CTR5300	4865533010	BS8424
7700419249	BS6002	SUBARU		4504629125	CTR5300	488200K010	CTR6115
7700424399	BS6002	20470SA010	CTR0300	4504629215	CTR5005	4882042030	CTR6160
7700799404	BS8131	20470SA011	CTR0300	4504629255	CTR5429L	4882047010	CTR5916
7701047415	CTR5726L	SUZUKI		4504629305	CTR5343A	48820B0010	CTR6211
7701047416	CTR5726R	4520069D00	CJ1084	4504629325	CTR5005A	4883020010	CTR5534
7701047812	CTR5726L	4520084000	CJ1084	4504629456	CTR5812	VOLVO	
7701047813	CTR5726R	TOYOTA		4504639105	CTR5300	032119554	CTR5140

ORIGINAL-NO.

ORIGINAL-NO.

VOLVO

1315074	CTR5921R
1315083	CTR5921L
1317446	CTR5921R
1317447	CTR5921L
1328877	CTR5921R
1328881	CTR5921L
274303	CTR5774
274456	CTR5774
274500	CTR5921L
274501	CTR5921R
30683232	CTR6191
30714466	CTR6191
30714685	CTR5774
30723103	CTR5921L
30723104	CTR5921R
30884179	CTR6015
31201180	CJ1259
31201181	CJ1259
31212548	CTR6191
3211955	CTR5140
3265974	CTR5140
8623576	CTR5923
8634736	CTR5774
8672445	CTR5774

VW

171407153D	CJ108
171407181APART	CJ108
171407182DPART	CJ108
171407365F	CJ832
171407365G	CJ832
171419811	CTR5140
171419811A	CTR5140
171419812	CTR5140
171419821	RE033
171419821A	RE033
191407181A	MO5414
191407181B	MO5414
191407181D	MO5414
191407181E	MO5414
191407182	BS6911
191407365	CJ957
191407365A	CJ957
191407365B	CJ957
191419803*	RE5192
191419803PART	RE5192
191419804*	RE5192
191419804PART	RE5192
191419811	CTR5191L
191419812	CTR5191R
191422803APART	RE5473
191422804APART	RE5473
1H0407151	CJ111L

VW

1H0407365	CJ1031
1J0407181	BS6417
1J0407365A	CJ986
1J0407365C	CJ986
1J0407365D	CJ986
1J0407365H	CJ986
1J0407365J	CJ986
1J0407366A	CJ987
1J0407366C	CJ987
1J0407366D	CJ987
1J0407366H	CJ987
1J0407366J	CJ987
1J0412331	MO6180
1J0412331B	MO6180
1J0412331C	MO6180
1J0422807B	RE8143
1J0422807E	RE8143
1J0422811B	CTR5706L
1J0422812B	CTR5706R
1K0199231G	BS6883
1K0199231J	BS6883
1K0199231P	BS6883
1K0199232G	BS6884
1K0199232J	BS6884
1K0199232P	BS6884
1K0407182	BS6899
1K0407182A	BS6899
1K0411315B	CTR5849
1K0411315D	CTR5849
1K0411315G	CTR5849
1K0411315J	CTR5849
1K0411315K	CTR5849
1K0411315N	CTR5849
1K0411315P	CTR5849
1K0411315R	CTR5849
1K0423810A	RE5841
251419811	CTR5140
2D0422811	CTR5542
2E0498104	CTR5927
2E0498104A	CTR5927
2E0713491	RE5928
2E0713501	CTR5927
2H0407183A	BS8272
32111116463	CTR5140
3211955	CTR5140
3265974	CTR5140
357407181	MO5414
357407182	BS6911
357407365	CJ864
357407365A	CJ864
3A0419811	CTR5191L
3A0422811	CTR5191L

VW

3A0422812	CTR5191R
477419811	CTR5140
477419815	CTR5140
4B0419811	CTR5491
4B0419811B	CTR5491
4B0419811C	CTR5491
4B0419811D	CTR5491
4B0419811E	CTR5491
4B0419811F	CTR5491
4D0407183D	BS7069
4D0407183M	BS7069
4D0407183N	BS7069
4D0407183P	BS7069
4D0407183Q	BS7069
4D0407509B	CJ1034
4D0407509D	CJ1034
4D0407510B	CJ1035
4D0407510D	CJ1035
4D0407515	BS7072
4D0407515C	BS7072
4D0407693E	CJ292
4D0407693H	CJ292
4D0407693K	CJ292
4D0407693M	CJ292
4D0407693N	CJ292
4D0407694E	CJ293
4D0407694H	CJ293
4D0407694K	CJ293
4D0407694M	CJ293
4D0407694N	CJ293
4D0419811A	CTR5491
4D0419811B	CTR5491
4D0419811G	CTR5491
4D0419811H	CTR5491
4F0419811E	CTR5491
4F0498811	CTR5491
5Z0407365B	CJ1090
5Z0407366B	CJ1091
5Z0423811	CTR5834L
5Z0423812	CTR5834R
6N0419811	CTR5191L
6N0419812	CTR5191R
6Q0407151D	CJ205L
6Q0407151E	CJ205L
6Q0407151L	CJ205L
6Q0407365A	CJ1090
6Q0407365M	CJ1090
6Q0407366A	CJ1091
6Q0407366M	CJ1091
6Q0411315A	CTR5605
6Q0411315B	CTR5605
6Q0411315C	CTR5605

VW

6Q0411315D	CTR5605
6Q0411315E	CTR5605
6Q0411315F	CTR5605
6Q0411315G	CTR5605
6Q0411315H	CTR5605
6Q0411315J	CTR5605
6Q0411315L	CTR5605
6Q0411315M	CTR5605
6Q0411315N	CTR5605
6Q0411315P	CTR5605
6Q0419812C	CTR5834R
6Q0423803PPART	RE5712
6Q0423811	CTR5834L
6Q0423811A	CTR5834L
6Q0423811C	CTR5834L
6Q0423812	CTR5834R
6Q0423812A	CTR5834R
6R0411315	CTR5605
6R0411315A	CTR5605
6R0423811	CTR5834L
6R0423812	CTR5834R
6X0422803A/4APA	RE0185
6X0422804A	RE0185
701419804F	RE5718
701419810B	RE5718
702419803D	RE5718
7E0407361	CJ1163
7H0407182A	BS8271
7H0407183	BS8272
7H0407361	CJ1163
7H0407361A	CJ1163
8D0407505B	CJ287
8D0407505F	CJ287
8D0407505H	CJ287
8D0407505K	CJ287
8D0407506B	CJ1033
8D0407506F	CJ1033
8D0407506H	CJ1033
8D0407506K	CJ1033
8E0419811B	CTR5491
8Z0411315D	CTR5605
94434733300	CTR5140

ORIGINAL-NO.

AUDI		AUDI		AUDI		BMW	
BS6417	1J0407181	CJ293	8E0407694E	MO6180	1J0412331C	CJ1150	31122405862
BS6883	1K0199231G	CJ986	1J0407365A	RE033	171419821	CJ1150	31122409598
BS6883	1K0199231J	CJ986	1J0407365C	RE5473	191422803APART	CJ1150	31124036270
BS6884	1K0199232G	CJ986	1J0407365D	RE5841	1K0423810A	CJ1150	31126763704
BS6884	1K0199232J	CJ986	1J0407365H	RE8143	1J0422807B	CJ1150	31126763708
BS6899	1K0407182	CJ986	1J0407365J	BMW		CJ1150	31126769798
BS6899	1K0407182A	CJ987	1J0407366A	BS5421	31129059288	CJ1150	31126769802
BS6911	191407182	CJ987	1J0407366C	BS5422	31121130123	CJ1151	31122347952
BS6911	357407182	CJ987	1J0407366D	BS5422	31121130140	CJ1151	31122347965
BS7069	4D0407183D	CJ987	1J0407366H	BS5422	31129058931	CJ1151	31124028608
BS7069	4D0407183M	CJ987	1J0407366J	BS6177	31121133710	CJ1151	31126760182
BS7069	4D0407183N	CTR5491	4B0419811	BS7204	31124004359	CJ1151	31126768298
BS7069	4D0407183P	CTR5491	4B0419811B	BS7205	31111096982	CJ1152	31122347951
BS7069	4D0407183Q	CTR5491	4B0419811C	BS7205	31121095277	CJ1152	31122347963
BS7072	4D0407515	CTR5491	4B0419811D	BS7205	31121095278	CJ1152	31124028607
BS7072	4D0407515C	CTR5491	4B0419811E	BS7205	31121096983	CJ1152	31126760181
CJ1033	8D0407506B	CTR5491	4B0419811F	BS7205	31121096984	CJ1152	31126768297
CJ1033	8D0407506F	CTR5491	4D0419811A	BS7205	31124000612	CJ142	31121094466
CJ1033	8D0407506H	CTR5491	4D0419811B	BS7205	31124004359	CJ142	31121096986
CJ1033	8D0407506K	CTR5491	4D0419811G	BS7205	31124004360	CJ142	31126750224
CJ1034	4D0407509B	CTR5491	4D0419811H	BS7205	31126750057S1	CJ142	31126751318
CJ1034	4D0407509D	CTR5491	4F0419811E	BS7205	31126750221	CJ142	31126752718
CJ1034	4D0407509K	CTR5491	4F0498811	BS7205	31126750222	CJ142	31126758520
CJ1035	4D0407510B	CTR5491	8E0419811B	BS7205	31126751372	CJ142	31126770248
CJ1035	4D0407510D	CTR5605	6Q0411315A	BS7205	31126751435	CJ142	31126774820
CJ1035	4D0407510K	CTR5605	6Q0411315B	BS7205	31126751436	CJ142	31126777852
CJ1175	8E0407151E	CTR5605	6Q0411315C	BS7205	31126753058	CJ143	31121094465
CJ1175	8E0407151K	CTR5605	6Q0411315D	BS7205	31126753059	CJ143	31121096985
CJ1175	8E0407151L	CTR5605	6Q0411315E	BS7205	31126753060	CJ143	31126750223
CJ1175	8E0407151M	CTR5605	6Q0411315F	BS7205	31126754547	CJ143	31126751317
CJ1175	8E0407151N	CTR5605	6Q0411315G	BS7205	31126754899	CJ143	31126752717
CJ1175	8E0407151R	CTR5605	6Q0411315H	BS7205	31126754900	CJ143	31126758519
CJ287	8D0407505B	CTR5605	6Q0411315J	BS7205	31126757623	CJ143	31126770247
CJ287	8D0407505F	CTR5605	6Q0411315L	BS7205	31129071663	CJ143	31126774819
CJ287	8D0407505H	CTR5605	6Q0411315M	BS7205	31129071952	CJ143	31126777851
CJ287	8D0407505K	CTR5605	6Q0411315N	BS7205	31129071963	CJ847	31121126254
CJ287	8E0407505A	CTR5605	6Q0411315P	CJ1065L	31121092023	CJ848	31121126253
CJ292	4D0407693AC	CTR5605	6R0411315	CJ1065L	31121141717	CJ848	31121126296
CJ292	4D0407693AD	CTR5605	6R0411315A	CJ1065R	31121092024	CJ848	31121139131
CJ292	4D0407693E	CTR5605	8Z0411315D	CJ1065R	31121141718	CJ863	31121096685
CJ292	4D0407693H	CTR5706L	1J0422811B	CJ1066L	31121093449	CJ863	31121140398
CJ292	4D0407693K	CTR5706R	1J0422812B	CJ1066L	31121093450	CJ863	31126758510
CJ292	4D0407693M	CTR5849	1K0411315B	CJ1066L	31121094233	CJ870L	31121094275
CJ292	4D0407693N	CTR5849	1K0411315D	CJ1066R	31121093450	CJ870L	31121136529
CJ292	8E0407693E	CTR5849	1K0411315G	CJ1066R	31121094234	CJ870L	31121140399
CJ293	4D0407694AC	CTR5849	1K0411315J	CJ1149	31122405861	CJ870L	31121140957
CJ293	4D0407694AD	CTR5849	1K0411315K	CJ1149	31122409599	CJ870L	31126758513
CJ293	4D0407694E	CTR5849	1K0411315N	CJ1149	31124036269	CJ870L	31126758515
CJ293	4D0407694H	CTR5849	1K0411315P	CJ1149	31126763703	CJ870R	31121094276
CJ293	4D0407694K	CTR5849	1K0411315R	CJ1149	31126763707	CJ870R	31121136530
CJ293	4D0407694M	MO6180	1J0412331	CJ1149	31126769797	CJ870R	31121140400
CJ293	4D0407694N	MO6180	1J0412331B	CJ1149	31126769801	CJ870R	31121140958

ORIGINAL-NO.

ORIGINAL-NO.

BMW

CJ870R	31126758514
CJ870R	31126758516
CTR5159	31351091764
CTR5159	31351127689
CTR5159	31351128737
CTR5380	31351124380
CTR5380	31351127194
CTR5380	31351128050
CTR5380	31351130075
CTR5380	31351134582
CTR5380	31352227203
CTR5605	31351095694
CTR5605	31356780847
CTR5875L	31356765933
CTR5875R	31356765934
RE046	32111139315PART
RE046	32111139316PART
RE5472	32111127124
RE5472	32111130449
RE5489	32111139318PART
RE5549	32111091767*
RE5549	32111091767PART
RE5549	32111091768*
RE5549	32111091768PART
RE5604	32111096897PART
RE5843	32216762243
RE5843	32216762244
RE5845	32106774347PART
RE5845	32106777479PART
RE5845	32216762403PART

CHEVROLET

BS8315	96535088
BS8315	96653381
CJ1089	90487561
CJ1089	90512982
CJ1089	90542995
CJ269L	96535081
CJ269L	96815893
CJ269L	96870465
CJ269R	96535082
CJ269R	96815894
CJ269R	96870466
CJ951	90141393
CJ951	90295479
CJ951	90297863
CTR5170	26059294
CTR5170	9118127
CTR5170	93186537
CTR5506	26011925
CTR5506	26087868
CTR5506	93192419
CTR5771	90496116

CHEVROLET

CTR5891	96391875
---------	----------

CHRYSLER

CJ1028	5099237AA
CTR5927	68020845AA
CTR5927	68047089AA
CTR6107	04797706
CTR6107	4797706
RE5928	68020843AA

CITROËN

CTR6130	508750
---------	--------

DAEWOO

BS8315	96535088
BS8315	96653381
CJ269L	96535081
CJ269L	96815893
CJ269L	96870465
CJ269R	96535082
CJ269R	96815894
CJ269R	96870466
CJ869	1603302
CTR5141	96129753
CTR5141	96205809
CTR5141	96446586
CTR5141	D96205809
CTR5891	96275798
CTR5891	96391875
CTR5891	D96275798
CTR5891	D96391875

FIAT

CJ1045	46543045
CTR5401	05958246
CTR5401	5958246
CTR5401	5958247
CTR5401	5983404
CTR5401	5983406
CTR5401	SE127162410A
MO5809	05960254
MO5809	5960254

FORD

BS6496	1010037
BS6496	1055191
BS6496	1E0034153A
BS6496	96FB3063AA
BS6496	96FB3063AB
BS6496	98FB3063AA
BS7411	1004011
BS7411	1014654
BS7411	1063372
BS7411	1E0134153A
BS7411	96FB3A262AD
BS7411	98FB3A262AA
CJ1205	UR6134550

FORD

CJ124	1058279
CJ124	6525743
CJ124	6525843
CJ124	6615742
CJ124	6732630
CJ124	6770224
CJ124	7102644
CJ124	7351747
CJ124	91AB3042AB
CJ124	91AB3042AD
CJ124	92AB3042AA
CJ124	92AB3042BA
CJ124	94AB3042AA
CJ124	95AB3042AB
CJ124	95AB3042AE
CJ125	1058280
CJ125	6525844
CJ125	6615743
CJ125	6732631
CJ125	6770225
CJ125	7102645
CJ125	7351748
CJ125	91AB3051AD
CJ125	92AB3051AA
CJ125	92AB3051BA
CJ125	94AB3051AA
CJ125	95AB3051AB
CJ125	95AB3051AD
CJ125	95AB3051AE
CJ1259	1470387
CJ1259	1679388
CJ1259	3M513K209BA
CJ1259	6829045
CJ1259	93BB5K653AB
CJ1259	ME4M5J3395AA
CJ159L	1003584
CJ159L	1003585
CJ159L	1009594
CJ159L	1009596
CJ159L	1015264
CJ159L	1017014
CJ159L	1021220
CJ159L	1045656
CJ159L	1046282
CJ159L	1046285
CJ159L	1063255
CJ159L	96FB3051BF
CJ159L	96FB3051BG
CJ159L	98FB3051CC
CJ159R	1003574
CJ159R	1003575
CJ159R	1009580

FORD

CJ159R	1009584
CJ159R	1015260
CJ159R	1017013
CJ159R	1021219
CJ159R	1045655
CJ159R	1046280
CJ159R	1046283
CJ159R	1063236
CJ159R	96FB3042BF
CJ159R	96FB3042BG
CJ159R	98FB3042CC
CJ582	1030025
CJ582	1030026
CJ582	1047797
CJ582	1047798
CJ582	7152281
CJ582	94FB3395A2A
CJ582	94FB3395A2B
CJ582	94FB3B376AA
CJ843	3240196
CJ843	3246130
CJ843	5021456
CJ843	6084942
CJ843	6087888
CJ843	6115333
CJ843	6115334
CJ843	81AB3A052AC
CJ843	86AB3078A2A
CJ844	3240197
CJ844	3246129
CJ844	5021457
CJ844	6084943
CJ844	6087889
CJ844	6115335
CJ844	6115336
CJ844	81AB3A053AC
CJ919	K9597
CJ964	1637182
CJ964	1637183
CJ964	5021458
CJ964	880X3B376CA
CJ965	1637184
CJ965	1637185
CJ965	5021459
CJ965	86AB3079A1A
CJ965	86AB3079A2A
CJ983	8AU334510
CTR1418	1513343
CTR1418	1745924
CTR1418	1790310
CTR1418	1905043
CTR1418	8V513B438AB

ORIGINAL-NO.

FORD

CTR1418	8V513B438BA
CTR1418	8V513B438BB
CTR1418	8V513B438BC
CTR5308	1454896
CTR5318	1004018
CTR5318	1061631
CTR5318	1067818
CTR5318	1130273
CTR5318	1135077
CTR5318	1661237
CTR5318	1E0034170
CTR5318	1S613B438AA
CTR5318	6186082
CTR5318	6188004
CTR5318	6198621
CTR5318	89FB3B438A1E
CTR5318	96FB3B438AB
CTR5318	98AG3B438AB
CTR5318	YS413B438BA
CTR5335	3669093
CTR5335	XM343289BA
CTR5921L	1315083
CTR5921R	1315074
CTR5923	1223792
CTR5923	1230909
CTR5923	3M513B438AB
CTR5984	UR5632250
CTR6172	1146150
CTR6172	1469212
CTR6172	1761200
CTR6172	2S613B438AC
CTR6172	2S613B438AD
CTR6172	2S613B438AE
CTR6191	1310333
CTR6191	1335548
CTR6191	1469208
RE5407	6131083
RE5407	6134277
RE5407	6185335
RE5407	6185336
RE5407	83BB3L519EA
RE5407	87BB3L519DA
RE5407	87BB3L519EA
RE5450	6135757
RE5450	6185338
RE5450	87GB3L519BA
RE5571	4342539
RE6092	1545457
RE6092	8V513L519AA

FOTON

CTR5005A	4504629325
RE188	4550329565

GONOW

CJ933	4335039035
CJ934	4333039165

GWM

CJ933	4335039035
CJ934	4333039165

HOLDEN

CJ1089	90487561
CJ1089	90512982
CJ1089	90542995
CJ951	90141393
CJ951	90295479
CJ951	90297863
CTR5771	90496116

HONDA

CJ610L	51460S01023
CJ610R	51450S01023
CJ962	51220SA0A01
CJ962	51220SB0003
CJ962	51220SE0000
CJ962	51220SE0003
CJ962	51220SF1000
CJ962	51220SF1100
CJ962	51220SH3003
CJ962	51220SK7003
CJ962	51220SK7013
CJ962	51220SM0A01
CTR5345L	53560SH3003
CTR5345L	53560SH3013
CTR5345R	53540SH3003
CTR5345R	53540SH3013
CTR5552	51320S04003
RE071	53010SR3010
RE5908	53010S04000

HYUNDAI

BS7860	545842E000
CJ1011	5450322A00
CJ1011	5450331600
CJ1011	5452031600
CJ1011	5453014200
CJ1011	5453031600
CTR3107	5553029000
CTR3107	5553029500
CTR3107	5553029500AS
CTR5474	5682025000
CTR5474	5682028520
CTR5474	5682037010
CTR5474	5685028520
CTR5567	568203B000
CTR5915L	548301C000
CTR5915R	548401C000
CTR6032	5483029000
RE6055	577240X000

ISUZU

CJ1221	898005827051
CJ930	8944594532
CJ930	8944594533
CJ930	8944594534
CJ936	89444594642
CJ936	8944594641
CJ936	8944594642
CJ936	94459464
CJ946	8944521020
CJ946	8944521021
CJ946	8944594651
CJ946	8944594652
CJ946	94452102
CTR5331L	8944194090
CTR5331L	8944194091
CTR5331L	8944594810
CTR5331L	8944594812
CTR5331R	324057
CTR5331R	8944194080
CTR5331R	8944194081
CTR5331R	8944594800
CTR5331R	8944594802
CTR5331R	920373
CTR5331R	94419408
CTR5331R	94459480
CTR5806	897304855051
CTR6182L	8979445690
CTR6182R	8979445680

KIA

BS7860	545842E000
--------	------------

MAZDA

BS6496	1010037
BS6496	1055191
BS6496	1E0034153A
BS7411	1014654
BS7411	1063372
BS7411	1E0134153A
CJ1199	GJ6A34300B
CJ1199	GJ6A34300C
CJ1199	GJ6A34300D
CJ1205	UR6134550
CJ159L	1E0034350A
CJ159L	1E0134350A
CJ159R	1E0034300A
CJ159R	1E0134300A
CJ294L	B32H34350
CJ294L	B32H34350A
CJ294L	B32H34350B
CJ294L	B32H34350C
CJ294L	B32H34350D
CJ294L	B32H34350E
CJ294L	B37F34350

MAZDA

CJ294L	B37F34350A
CJ294L	B37F34350B
CJ294L	BP4K34350
CJ294L	BP4K34350A
CJ294L	BP4K34350B
CJ294L	BP4K34350C
CJ294L	BP4K34350D
CJ294L	BP4K34350E
CJ294L	C51334350
CJ294L	CC3034350
CJ294L	CC3034350A
CJ294L	CC3034350B
CJ294L	CC3034350C
CJ294L	CC3034350D
CJ294L	CC3034350E
CJ294R	B32H34300
CJ294R	B32H34300A
CJ294R	B32H34300B
CJ294R	B32H34300C
CJ294R	B32H34300D
CJ294R	B32H34300E
CJ294R	B37F34300
CJ294R	B37F34300A
CJ294R	B37F34300B
CJ294R	BP4K34300
CJ294R	BP4K34300A
CJ294R	BP4K34300B
CJ294R	BP4K34300C
CJ294R	BP4K34300D
CJ294R	BP4K34300E
CJ294R	BP4K34300E
CJ294R	C51334300
CJ294R	CC3034300
CJ294R	CC3034300A
CJ294R	CC3034300B
CJ294R	CC3034300C
CJ294R	CC3034300D
CJ294R	CC3034300E
CJ582	94FB3395A2B
CJ919	K9597
CJ926	B00134550
CJ926	B09234550
CJ983	8AU334510
CTR1418	D65134170
CTR1418	D65134170A
CTR5184	8AB032280
CTR5184	8AB232280
CTR5184	B45532280
CTR5308	6M343280AA
CTR5318	1130273
CTR5318	1E0034170
CTR5335	8AU132280
CTR5335	UH7432280

ORIGINAL-NO.

MAZDA

CTR5527	LC6234170
CTR5527	LC6234170B
CTR5923	BP4K34170C
CTR5984	UR5632250
CTR6172	DD3234170
CTR6172	DD3234170A
CTR6172	DD3234170B
CTR6191	1335548
CTR6191	BP4K28170C
CTR6191	BP4K28170D
RE014	B09232240
RE014	BF6232240
RE014	BF6732240
RE014	BF673224X
RE5946	BP4L32240
RE5948	GJ6A32240
RE6092	D65132240

MERCEDES-BENZ

CJ1028	2023330027
CJ1028	2103300035
CJ1028	2103330427
CJ1028	2113300335
CJ1028	2203300635
CJ1143	1693330127
CJ1193	2113300235
CJ1193	2113300435
CJ1193	2203330127
CJ1193	2203330227
CJ1193	2203330327
CJ1193	2203330427
CJ1193	2203330727
CJ996L	2033301911
CJ996L	2033303311
CJ996L	2043301911
CJ996R	2033302011
CJ996R	2033303411
CJ996R	2043302011
CJ997L	2033300111
CJ997L	2033301611
CJ997L	2033303511
CJ997L	2033303911
CJ997L	2043304311
CJ997R	2033300211
CJ997R	2033301711
CJ997R	2033303611
CJ997R	2033304011
CJ997R	2043304411
CTR5172	1233380210
CTR5497	0013307435
CTR5497	0013307735
CTR5542	9014600048
CTR5542	9014600148

MERCEDES-BENZ

CTR5542	9014600248
CTR5542	9014600348
CTR5781L	2033301903
CTR5781L	2033303903
CTR5783	2033200489
CTR5783	2033202589
CTR5783	2033202889
CTR5927	90610481001
CTR5927	90610481003
CTR5927	9064600048
CTR5927	9064600148
CTR5927	9064600348
CTR6047R	2043201889
RE5444	2103380415
RE5782	2203380715
RE5782	2303380015
RE5928	90610551003
RE5928	9064600055

MINI

CTR5380	31351130075
CTR5380	31351134582

MITSUBISHI

CJ904	MB860829
CJ904	MB860830
CJ961L	MB831037
CJ961L	MR296269
CJ961R	MB831038
CJ961R	MR296270
CTR5556	MB831044
CTR5557	MB831043

NISSAN

BS8131	5461600QAA
BS8147	54500AX600
BS8147	54500BC41A
BS8147	54500BC42A
BS8147	54501AX600
BS8147	54501BC41A
BS8147	54501BC42A
BS8147	54560AX600
BS8218	54500AX600
BS8218	54501AX600
BS8218	54560AX600
BS8218	54570AX600
CJ787	40160B1001
CJ912	4016001G00
CJ912	4016001G25
CJ912	4016001G50
CJ912	4016001G90
CJ912	4016001N25
CTR1366L	48641H1001
CTR1366L	48641H5025
CTR1366L	48641W5025

NISSAN

CTR1366R	48521H1001
CTR1366R	48521H5025
CTR1366R	48521W5025
CTR1367L	48640H1001
CTR1367R	48520H1001
CTR5309	4852131G25
CTR5309	4857031G25
CTR5310	4852101G25
CTR5559	5461850Y00
CTR5559	5461858820
CTR5559	54618D5000
CTR5559	54618D5010
CTR5600	D8520VK91A
CTR5601	485212S425
CTR5675L	546688H300
CTR5675R	546188H300
CTR5682	546184M400
CTR5699	485703S500
CTR5700	485200W025
CTR5770	54618AX600
CTR6150L	54668EA010
CTR6150L	54668EB30A
CTR6150R	54618EA010
CTR6150R	54618EB30A
RE053	4852150400
RE053	4852150Y00
RE5990	485213U025

OPEL

BS6102	352309
BS6103	352310
BS6103	352320
BS6383	0352347
BS6383	0352348
BS6383	0352352
BS6383	352347
BS6383	352348
BS6383	352352
BS6383	90268463
BS6383	90288082
BS6406	0352300
BS6406	0352346
BS6406	0352351
BS6406	352300
BS6406	352346
BS6406	352351
BS6406	90288232
BS6406	90373778
CJ1089	352800
CJ1089	352829
CJ1089	352830
CJ1501L	0352074
CJ1501L	0352075

OPEL

CJ1501L	0352077
CJ1501L	0352143
CJ1501L	0352163
CJ1501L	0352193
CJ1501L	352074
CJ1501L	352075
CJ1501L	352077
CJ1501L	352143
CJ1501L	352163
CJ1501L	352193
CJ1501L	5352001
CJ1501L	5352015
CJ1501L	90373779
CJ1501L	90473226
CJ1501L	90495103
CJ1501R	90495159
CJ1501R	0352076
CJ1501R	0352192
CJ1501R	352076
CJ1501R	352192
CJ1501R	5352000
CJ1501R	90473227
CJ1501R	90495104
CJ1501R	90495160
CJ654	352803
CJ869	025260037576
CJ869	1603202
CJ869	1603302
CJ869	1603302
CJ869	90539896
CJ930	310821
CJ946	0352822
CJ946	0352828
CJ946	352822
CJ946	352828
CJ946	8944594652
CJ946	94459465
CJ951	1603121
CJ951	1603163
CJ951	1603167
CTR2462	350611
CTR2462	350614
CTR5170	1603214
CTR5170	1603215
CTR5170	1603542
CTR5331L	0920374
CTR5331L	920374
CTR5331L	94459481
CTR5331R	0920373
CTR5331R	920373
CTR5427L	0324053
CTR5427L	0324055
CTR5427L	324053

ORIGINAL-NO.

OPEL

CTR5427L	324055
CTR5427R	0324054
CTR5427R	0324056
CTR5427R	324054
CTR5427R	324056
CTR5500	1603455
CTR5500	324066
CTR5506	1603009
CTR5506	1603645
CTR5506	324050
CTR5643	350263
CTR5771	350610
MO6848	0344523
MO6848	344523
MO6848	90468554
RE056	1603018
RE056	1603843
RE5499	1603008
RE5499	1603845
RE5547	1603213
RE5547	1603216
RE5547	1603287
RE5547	1603303
RE5815	0322158
RE5815	322158

PEUGEOT

CTR6130	508750
CTR6130	96347856
RE5651	3812C5

PORSCHE

CJ108	171407153D
CJ108	171407181APART
CJ108	171407182DPART
CJ832	171407365F
CJ832	171407365G
CTR5140	171419811

RENAULT

BS6002	7700418941
BS6002	7700419236
BS6002	7700419249
BS6002	7700424399
BS6819	8200041166
BS8131	7700799404
BS8147	8200183569
BS8147	8200346941
BS8147	8200346942
BS8218	8200183570
BS8218	8200346941
BS8218	8200346942
BS8218	8200696437
CJ1145	8200298454PART
CJ1145	8200298455PART

RENAULT

CJ1145	8200346941
CJ1145	8200346942
CJ1145	8200457209
CJ1145	8200615057
CJ1145	8200615058
CJ1145	8200679067
CJ1145	8200744091
CJ1145	8200744092
CJ299L	8200346941
CJ299L	8200615057
CJ299L	8200744091
CJ299R	8200346942
CJ299R	8200615058
CJ299R	8200744092
CTR5726L	7701047415
CTR5726L	7701047812
CTR5726L	7701474492
CTR5726L	7701475842
CTR5726L	7701476760
CTR5726L	7701476762
CTR5726R	7701047416
CTR5726R	7701047813
CTR5726R	7701474493
CTR5726R	7701475843
CTR5726R	7701476761
CTR5726R	7701476763
CTR5770	8200127308
CTR5985L	6001547610
CTR5985L	6001550442
CTR5985R	6001547611
CTR5985R	6001550443
RE5902	7701474448
RE5986	6001547606
RE5986	6001550441

SAAB

CJ1089	4835740
CJ1089	5231683
CJ1089	93185278
CTR5427L	4242749
CTR5427R	4242756
CTR5643	30540743
CTR5643	4400040
CTR5643	4544599
CTR5771	4686606
CTR5771	5236823

SUBARU

CTR0300	20470SA010
CTR0300	20470SA011

SUZUKI

CJ1084	4520069D00
CJ1084	4520084000

TOYOTA

TOYOTA

BS6455	4865512120
BS8424	4865507010
BS8424	4865533010
CJ1168L	
CJ1168R	
CJ1169	
CJ1170L	
CJ1170R	
CJ1187	4333009295
CJ1187	4333009490
CJ1187	4333009510
CJ1188	
CJ266L	4806902020
CJ266L	4806902021
CJ266L	4806902030
CJ266L	4806902070
CJ266L	4806902080
CJ266L	4806912220
CJ266L	4806912260
CJ266L	4806913010
CJ266R	4806802020
CJ266R	4806802021
CJ266R	4806802030
CJ266R	4806802070
CJ266R	4806802080
CJ266R	4806812220
CJ266R	4806812260
CJ266R	4806813010
CJ281	4333029175
CJ914	4334019015
CJ914	4334019016
CJ915	4333019065
CJ915	4333019066
CJ931	4333029125
CJ931	4334029105
CJ932	4335029045
CJ932	4335029056
CJ932	4336029065
CJ932	4336029076
CJ933	4335039035
CJ934	4333039165
CJ935	4333029135
CJ935	4333029136
CJ935	4333029137
CJ935	4333029138
CJ935	4333029139
CJ935	4333029140
CJ935	4333029205
CJ949	4333009070
CJ949	4333009090
CJ949	4333009230
CJ949	4333009640

TOYOTA

CJ949	4333019115
CJ949	4333049045
CJ949	4333069015
CJ981	4335039045
CJ981	4336039085
CJ984	4335029065
CJ984	4335029095
CTR5005	4504629215
CTR5005	4504660081
CTR5005	4504669055
CTR5005A	4504629325
CTR5300	4504629115
CTR5300	4504629125
CTR5300	4504639105
CTR5300	4504639106
CTR5300	4504639125
CTR5300	4504639165
CTR5300	4504639175
CTR5300	4504639215
CTR5300	4504639235
CTR5300	4504639355
CTR5300	4504639375
CTR5300	4504639385
CTR5301	4540629115
CTR5317	4540629145
CTR5317	4540629175
CTR5343A	4504619175
CTR5343A	4504629305
CTR5429L	4504609020
CTR5429L	4504629255
CTR5470R	4504609360
CTR5470R	4504619265
CTR5470R	4504649115
CTR5534	4883020010
CTR5812	4504629456
CTR5916	4882047010
CTR6115	488200K010
CTR6160	4882042030
CTR6211	48820B0010
RE030	4550319125
RE049	4550319116
RE049	4550329255
RE188	4550329565
RE188	4550329565
RE2406	4550312130
RE5463	4550319215
RE5957	4550002130
RE5957	4550002300
RE5957	4551012390
RE5975	4550349105

VOLVO

CJ1259	31201180
--------	----------

ORIGINAL-NO.

VOLVO

CJ1259	31201181
CTR5140	032119554
CTR5140	3211955
CTR5140	3265974
CTR5774	274303
CTR5774	274456
CTR5774	30714685
CTR5774	8634736
CTR5774	8672445
CTR5921L	1315083
CTR5921L	1317447
CTR5921L	1328881
CTR5921L	274500
CTR5921L	30723103
CTR5921R	1315074
CTR5921R	1317446
CTR5921R	1328877
CTR5921R	274501
CTR5921R	30723104
CTR5923	8623576
CTR6015	30884179
CTR6191	30683232
CTR6191	30714466
CTR6191	31212548

VW

BS6417	1J0407181
BS6883	1K0199231G
BS6883	1K0199231J
BS6883	1K0199231P
BS6884	1K0199232G
BS6884	1K0199232J
BS6884	1K0199232P
BS6899	1K0407182
BS6899	1K0407182A
BS6911	191407182
BS6911	357407182
BS7069	4D0407183D
BS7069	4D0407183M
BS7069	4D0407183N
BS7069	4D0407183P
BS7069	4D0407183Q
BS7072	4D0407515
BS7072	4D0407515C
BS8271	7H0407182A
BS8272	2H0407183A
BS8272	7H0407183
CJ1031	1H0407365
CJ1033	8D0407506B
CJ1033	8D0407506F
CJ1033	8D0407506H
CJ1033	8D0407506K
CJ1034	4D0407509B

VW

CJ1034	4D0407509D
CJ1035	4D0407510B
CJ1035	4D0407510D
CJ108	171407153D
CJ108	171407181APART
CJ108	171407182DPART
CJ1090	5Z0407365B
CJ1090	6Q0407365A
CJ1090	6Q0407365M
CJ1091	5Z0407366B
CJ1091	6Q0407366A
CJ1091	6Q0407366M
CJ111L	1H0407151
CJ1163	7E0407361
CJ1163	7H0407361
CJ1163	7H0407361A
CJ205L	6Q0407151D
CJ205L	6Q0407151E
CJ205L	6Q0407151L
CJ287	8D0407505B
CJ287	8D0407505F
CJ287	8D0407505H
CJ287	8D0407505K
CJ292	4D0407693E
CJ292	4D0407693H
CJ292	4D0407693K
CJ292	4D0407693M
CJ292	4D0407693N
CJ293	4D0407694E
CJ293	4D0407694H
CJ293	4D0407694K
CJ293	4D0407694M
CJ293	4D0407694N
CJ832	171407365F
CJ832	171407365G
CJ864	357407365
CJ864	357407365A
CJ957	191407365
CJ957	191407365A
CJ957	191407365B
CJ986	1J0407365A
CJ986	1J0407365C
CJ986	1J0407365D
CJ986	1J0407365H
CJ986	1J0407365J
CJ987	1J0407366A
CJ987	1J0407366C
CJ987	1J0407366D
CJ987	1J0407366H
CJ987	1J0407366J
CTR5140	171419811
CTR5140	171419811A

VW

CTR5140	171419812
CTR5140	251419811
CTR5140	32111116463
CTR5140	3211955
CTR5140	3265974
CTR5140	477419811
CTR5140	477419815
CTR5140	94434733300
CTR5191L	191419811
CTR5191L	3A0419811
CTR5191L	3A0422811
CTR5191L	6N0419811
CTR5191R	191419812
CTR5191R	3A0422812
CTR5191R	6N0419812
CTR5491	4B0419811
CTR5491	4B0419811B
CTR5491	4B0419811C
CTR5491	4B0419811D
CTR5491	4B0419811E
CTR5491	4B0419811F
CTR5491	4D0419811A
CTR5491	4D0419811B
CTR5491	4D0419811G
CTR5491	4D0419811H
CTR5491	4F0419811E
CTR5491	4F0498811
CTR5491	8E0419811B
CTR5542	2D0422811
CTR5605	6Q0411315A
CTR5605	6Q0411315B
CTR5605	6Q0411315C
CTR5605	6Q0411315D
CTR5605	6Q0411315E
CTR5605	6Q0411315F
CTR5605	6Q0411315G
CTR5605	6Q0411315H
CTR5605	6Q0411315J
CTR5605	6Q0411315L
CTR5605	6Q0411315M
CTR5605	6Q0411315N
CTR5605	6Q0411315P
CTR5605	6R0411315
CTR5605	6R0411315A
CTR5605	8Z0411315D
CTR5706L	1J0422811B
CTR5706R	1J0422812B
CTR5834L	5Z0423811
CTR5834L	6Q0423811
CTR5834L	6Q0423811A
CTR5834L	6Q0423811C
CTR5834L	6R0423811

VW

CTR5834R	5Z0423812
CTR5834R	6Q0419812C
CTR5834R	6Q0423812
CTR5834R	6Q0423812A
CTR5834R	6R0423812
CTR5849	1K0411315B
CTR5849	1K0411315D
CTR5849	1K0411315G
CTR5849	1K0411315J
CTR5849	1K0411315K
CTR5849	1K0411315N
CTR5849	1K0411315P
CTR5849	1K0411315R
CTR5927	2E0498104
CTR5927	2E0498104A
CTR5927	2E0713501
MO5414	191407181A
MO5414	191407181B
MO5414	191407181D
MO5414	191407181E
MO5414	357407181
MO6180	1J0412331
MO6180	1J0412331B
MO6180	1J0412331C
RE0185	6X0422803A/4APA
RE0185	6X0422804A
RE033	171419821
RE033	171419821A
RE5192	191419803*
RE5192	191419803PART
RE5192	191419804*
RE5192	191419804PART
RE5473	191422803APART
RE5473	191422804APART
RE5712	6Q0423803PPART
RE5718	701419804F
RE5718	701419810B
RE5718	702419803D
RE5841	1K0423810A
RE5928	2E0713491
RE8143	1J0422807B
RE8143	1J0422807E

BS5421



Height [mm] : 34
 Inner Diameter [mm] : 18
 Outer diameter [mm] : 60

BS5422



Height [mm] : 33
 Inner Diameter [mm] : 18
 Outer diameter [mm] : 60

BS6002



Height [mm] : 46
 Outer diameter 1 [mm] : 45
 Outer diameter 2 [mm] : 59

BS6102



BS6103



BS6177



Height 1 [mm] : 47
 Height 2 [mm] : 56
 Inner Diameter [mm] : 14
 Outer diameter [mm] : 58

BS6383



Height 1 [mm] : 27
 Height 2 [mm] : 58
 Inner Diameter [mm] : 16
 Outer diameter 1 [mm] : 60
 Outer diameter 2 [mm] : 66

BS6406



Inner Diameter [mm] : 12
 Outer diameter 1 [mm] : 39
 Outer diameter 2 [mm] : 44

BS6417



Height 1 [mm] : 25
 Height 2 [mm] : 41
 Inner Diameter [mm] : 13
 Outer diameter [mm] : 60

BS6496



Height 1 [mm] : 44
 Height 2 [mm] : 62
 Inner Diameter [mm] : 12
 Outer diameter 1 [mm] : 24
 Outer diameter 2 [mm] : 37

BS6819



Inner Diameter [mm] : 12
 Outer diameter [mm] : 24
 Outer diameter [mm] : 58

BS6883



BS6884



BS6899



BS6911



Height [mm] : 54
 Inner Diameter [mm] : 12
 Outer diameter 1 [mm] : 33
 Outer diameter 2 [mm] : 36

BS7069



Height 1 [mm] : 66
 Height 2 [mm] : 80
 Inner Diameter [mm] : 12
 Outer diameter [mm] : 65

PICTURES

BS7072



Height 1 [mm] : 26
 Height 2 [mm] : 40
 Inner Diameter [mm] : 10
 Outer diameter 1 [mm] : 24
 Outer diameter 2 [mm] : 46

BS7204



Diameter [mm] : 66

BS7205



Diameter [mm] : 66

BS7411



Height [mm] : 50
 Inner Diameter [mm] : 12
 Outer diameter [mm] : 66

BS7860



Height 1 [mm] : 60
 Height 2 [mm] : 36.7
 Inner Diameter [mm] : 14.1
 Outer diameter [mm] : 66.4

BS8131



Inner Diameter [mm] : 12
 Outer diameter [mm] : 40

BS8147



BS8218



Height [mm] : 53
 Inner Diameter [mm] : 12
 Outer diameter [mm] : 58

BS8271



BS8272



Height [mm] : 60.3
 Inner Diameter [mm] : 14.1
 Outer diameter 1 [mm] : 51.5
 Outer diameter 2 [mm] : 40.3

BS8315



Height [mm] : 46
 Inner Diameter [mm] : 12
 Outer diameter [mm] : 60

BS8424



Height [mm] : 62.6
 Inner Diameter [mm] : 14.3
 Outer diameter [mm] : 60.3

CJ1011



Cone Pitch : 1/8
 Cone Size [mm] : 15

CJ1028



Cone Size [mm] : 16
 Outer thread [mm] : M14 x 1,50

CJ1031



Cone Size [mm] : 16.5
 Outer thread [mm] : M12 x 1,50

CJ1033



Cone Size [mm] : 15.9
 Length [mm] : 278

CJ1034



Length [mm] : 249

CJ1035



Length [mm] : 251

CJ1045



CJ1065L



Cone Size [mm] : 14
Length [mm] : 430

CJ1065R



Cone Size [mm] : 14
Length [mm] : 430
Outer thread [mm] : M14 x 1,25

CJ1066L



Cone Size [mm] : 14.2
Length [mm] : 315

CJ1066R



Cone Size [mm] : 14.2
Length [mm] : 315

CJ108



CJ1084



CJ1089



Cone Size [mm] : 18

CJ1090



Cone Size [mm] : 14,9
Outer thread [mm] : M12 x 1,50

CJ1091



Cone Size [mm] : 14,9
Outer thread [mm] : M12 x 1,50

CJ111L



CJ1143



Cone Size [mm] : 15,5
Outer thread [mm] : M14 x 1,50

CJ1145



Outer diameter 1 [mm] : 38,3
Outer diameter 2 [mm] : 46

CJ1149



PICTURES

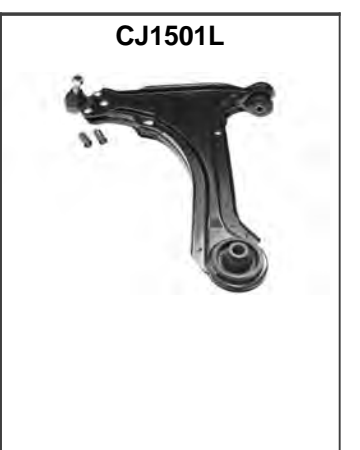
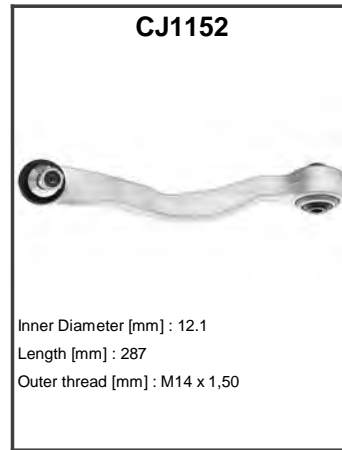
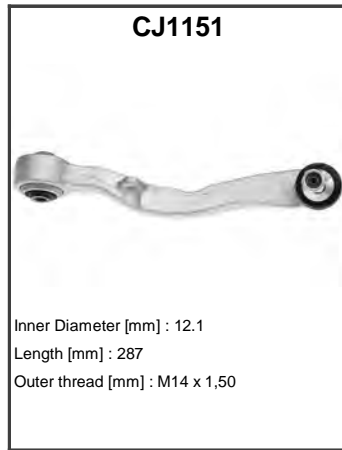
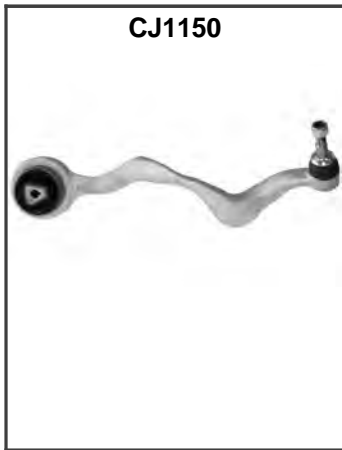

PICTURES

CJ1501R



CJ159L



CJ159R



CJ205L



CJ266L



CJ266R



CJ269L



Thread Size : M12x1.25

CJ269R



Thread Size : M12x1.25

CJ281



Cone Pitch : 1/8
Cone Size [mm] : 16.8

CJ287



Cone Size [mm] : 16
Length [mm] : 276

CJ292



Cone Size [mm] : 15.4
Length [mm] : 385

CJ293



Cone Size [mm] : 15.4
Length [mm] : 385

CJ294L



CJ294R



CJ299L



CJ299R



PICTURES



CJ870R



CJ877



CJ904



Cone Pitch : 1/8
Cone Size [mm] : 15.9

CJ912



Cone Size [mm] : 19.6
Outer thread [mm] : M18 x 1,50

CJ914



Cone Size [mm] : 15.53
Inner Thread [mm] : M12 x 1,25
Outer thread [mm] : M14 x 1,50

CJ915



Cone Size [mm] : 15.53
Inner Thread [mm] : M12 x 1,25
Outer thread [mm] : M14 x 1,50

CJ918



Cone Pitch : 1/8
Cone Size [mm] : 13.7
Diameter 1 [mm] : 13

CJ919



CJ926



Cone Size [mm] : 16

CJ930



Cone Size [mm] : 17.5
Outer thread [mm] : M14 x 1,50

CJ931



Cone Size [mm] : 18.2

CJ932



Cone Size [mm] : 17

CJ933



CJ934



CJ935



Cone Size [mm] : 15.5
Outer thread [mm] : M14 x 1,50

CJ936



PICTURES



CJ996R



CJ997L



CJ997R



CTR0300



CTR1367L



CTR1367R



CTR1418



Length [mm] : 250.5
Outer thread 1 [mm] : M10 x 1,50
Outer thread 2 [mm] : M10 x 1,50

CTR2462



Length [mm] : 300

CTR3107



CTR5005



Cone Size [mm] : 14.6
Inner Thread [mm] : M17 x 1,50
Length [mm] : 121
Outer thread [mm] : M14 x 1,50

CTR5005A



CTR5140



Cone Pitch : 1/10
Cone Size [mm] : 12.7
Inner Thread [mm] : M14 x 1,50
Length [mm] : 75

CTR5141



Cone Pitch : 1/8
Cone Size [mm] : 13.3
Inner Thread [mm] : M14 x 1,50
Length [mm] : 74

CTR5159



Diameter [mm] : 10
Length [mm] : 70

CTR5170



Cone Size [mm] : 13.3
Inner Thread [mm] : M14 x 1,50
Length [mm] : 134

CTR5172



Cone Size [mm] : 12.6
Length [mm] : 95
Outer thread 1 [mm] : M10 x 1,25
Outer thread 2 [mm] : M16 x 1,50 LHT M

PICTURES

CTR5184



Cone Size [mm] : 13.23
 Inner Thread [mm] : M12 x 1,25
 Length [mm] : 74

CTR5191L



Cone Size [mm] : 12.8
 Inner Thread [mm] : M14 x 1,50
 Length [mm] : 74.9

CTR5191R



Cone Size [mm] : 12.8
 Inner Thread [mm] : M14 x 1,50
 Length [mm] : 74.9

CTR5300



Cone Pitch : 1/10
 Cone Size [mm] : 14.5
 Length [mm] : 90
 Outer thread [mm] : M17 x 1,50 LHT M

CTR5301



CTR5308



CTR5309



Cone Pitch : 1/8
 Cone Size [mm] : 13.3
 Length [mm] : 128
 Outer thread [mm] : M16 x 1,50 LHT M

CTR5310



Cone Pitch : 1/8
 Cone Size [mm] : 13.425
 Length [mm] : 220
 Outer thread [mm] : M18 x 1,50

CTR5317



Cone Pitch : 1/10
 Cone Size [mm] : 14.2
 Length [mm] : 270
 Outer thread [mm] : M17 x 1,50

CTR5318



Length [mm] : 239
 Outer thread [mm] : M10 x 1,25

CTR5331L



Cone Size [mm] : 16.2
 Inner Thread [mm] : M14 x 1,50 LHT F
 Length [mm] : 75

CTR5331R



Cone Size [mm] : 16
 Inner Thread [mm] : M14 x 1,50

CTR5335



Cone Size [mm] : 13.85
 Inner Thread [mm] : M14 x 1,50 LHT F
 Length [mm] : 85

CTR5338



Cone Pitch : 1/8
 Cone Size [mm] : 13.5
 Inner Thread [mm] : M14 x 1,50
 Length [mm] : 157

CTR5339



Cone Pitch : 1/8
 Cone Size [mm] : 13.25
 Inner Thread [mm] : M14 x 1,50 LHT F
 Length [mm] : 84.5

CTR5343A



Cone Pitch : 1/6
 Cone Size [mm] : 12.5
 Inner Thread [mm] : M14 x 1,50
 Length [mm] : 83

CTR5345L



Cone Pitch : 1/10
Cone Size [mm] : 12.7
Inner Thread [mm] : M14 x 1,50
Length [mm] : 180

CTR5345R



Cone Size [mm] : 13
Inner Thread [mm] : M14 x 1,50
Length [mm] : 180

CTR5380



Length [mm] : 240

CTR5401



Cone Pitch : 1/10
Cone Size [mm] : 11.95
Inner Thread [mm] : M12 x 1,50
Length [mm] : 127

CTR5427L



Cone Size [mm] : 13.2
Inner Thread [mm] : M16 x 2,00
Length [mm] : 67

CTR5427R



Cone Size [mm] : 13.2
Inner Thread [mm] : M16 x 2,00 LHT F
Length [mm] : 67

CTR5429L



Cone Size [mm] : 12.5
Inner Thread [mm] : M15 x 1,50
Length [mm] : 88

CTR5470L



Cone Size [mm] : 12.55
Length [mm] : 163

CTR5470R



Cone Size [mm] : 12.55
Length [mm] : 163

CTR5474



Inner Thread [mm] : M14 x 1,50

CTR5491



Inner Thread [mm] : M8 x 1,25
Length [mm] : 156
Outer thread [mm] : M14 x 1,50

CTR5497



Cone Pitch : 1/10
Cone Size [mm] : 14.6
Inner Thread [mm] : M12 x 1,50
Length [mm] : 72

CTR5500



Cone Size [mm] : 10.6
Inner Thread [mm] : M12 x 1,50
Length [mm] : 80

CTR5506



Cone Size [mm] : 10.6
Inner Thread [mm] : M12 x 1,50
Length [mm] : 67
Outer thread [mm] : M10 x 1,25

CTR5534



CTR5542



Cone Size [mm] : 18.1
Inner Thread [mm] : M16 x 1,50
Length [mm] : 78
Outer thread [mm] : M16 x 1,50

PICTURES

CTR5552



CTR5556



Cone Pitch : 1/10
Cone Size [mm] : 13.6
Length [mm] : 171
Outer thread [mm] : M16 x 1,50

CTR5557



Cone Pitch : 1/8
Cone Size [mm] : 13.65
Length [mm] : 110
Outer thread [mm] : M16 x 1,50 LHT M

CTR5559



Length [mm] : 85

CTR5567



Cone Size [mm] : 13,4
Inner Thread [mm] : M14 x 1,50
Length [mm] : 72
Outer thread [mm] : M10 x 1,25

CTR5601



CTR5605



Length [mm] : 271
Outer thread 1 [mm] : M10 x 1,50
Outer thread 2 [mm] : M10 x 1,50

CTR5643



Length [mm] : 87
Outer thread [mm] : M12 x 1,50

CTR5675L



CTR5675R



CTR5682



Length [mm] : 92,5
Outer thread 1 [mm] : M10 x 1,50
Outer thread 2 [mm] : M10 x 1,25

CTR5699



CTR5700



CTR5706L



Cone Size [mm] : 13.2
Inner Thread [mm] : M14 x 1,50
Length [mm] : 95

CTR5706R



Cone Size [mm] : 13.2
Inner Thread [mm] : M14 x 1,50
Length [mm] : 95

CTR5726L



Cone Size [mm] : 11.8
Inner Thread [mm] : M14 x 1,50
Length [mm] : 90

CTR5726R



Cone Size [mm] : 11.8
 Inner Thread [mm] : M14 x 1,50
 Length [mm] : 90

CTR5770



Length [mm] : 248
 Outer thread [mm] : M10 x 1,25

CTR5771



Length [mm] : 245
 Outer thread [mm] : M12 x 1,50

CTR5774



CTR5781L



Cone Size [mm] : 16.15
 Inner Thread [mm] : M14 x 1,50
 Length [mm] : 175

CTR5783



Length [mm] : 276
 Outer thread [mm] : M10 x 1,50

CTR5806



CTR5812



CTR5834L



Cone Size [mm] : 13.2
 Inner Thread [mm] : M14 x 1,50
 Length [mm] : 95

CTR5834R



Cone Size [mm] : 13.2
 Inner Thread [mm] : M14 x 1,50
 Length [mm] : 95

CTR5849



Length [mm] : 335
 Outer thread 1 [mm] : M12 x 1,50
 Outer thread 2 [mm] : M12 x 1,50

CTR5875L



Length [mm] : 290.5
 Outer thread 1 [mm] : M10 x 1,50
 Outer thread 2 [mm] : M10 x 1,50

CTR5875R



Length [mm] : 290.5
 Outer thread 1 [mm] : M10 x 1,50
 Outer thread 2 [mm] : M10 x 1,50

CTR5891



CTR5915L



Length [mm] : 202
 Outer thread [mm] : M10 x 1,25

CTR5915R



Length [mm] : 202
 Outer thread [mm] : M10 x 1,25

PICTURES

CTR5916



CTR5921L



Cone Size [mm] : 12.5
 Inner Thread [mm] : M16 x 1,5 mm RHT
 Length [mm] : 100

CTR5921R



Cone Size [mm] : 12.5
 Inner Thread [mm] : M16 x 1,5 mm RHT
 Length [mm] : 100

CTR5923



Length [mm] : 298
 Thread Size : M10 x 1,5 mm

CTR5927



Cone Size [mm] : 16.85
 Inner Thread [mm] : M16 x 1,50
 Length [mm] : 90
 Outer thread [mm] : M14 x 1,50

CTR5984



CTR5985L



Cone Size [mm] : 12
 Inner Thread [mm] : M14 x 1,5 mm RHT
 Length [mm] : 213

CTR5985R



Cone Size [mm] : 12
 Inner Thread [mm] : M14 x 1,5 mm RHT
 Length [mm] : 213

CTR6014L



Length [mm] : 139
 Outer thread 1 [mm] : M12 x 1,25
 Outer thread 2 [mm] : M12 x 1,25

CTR6014R



Length [mm] : 139
 Outer thread 1 [mm] : M12 x 1,25
 Outer thread 2 [mm] : M12 x 1,25

CTR6015



Length [mm] : 267
 Outer thread [mm] : M10 x 1,25

CTR6032



CTR6047R



Length [mm] : 306
 Outer thread 1 [mm] : M12 x 1,50
 Outer thread 2 [mm] : M12 x 1,50

CTR6107



Cone Size [mm] : 12.35
 Inner Thread [mm] : M14 x 1,50

CTR6115



CTR6130



Length [mm] : 335
 Outer thread 1 [mm] : M10 x 1,50
 Outer thread 2 [mm] : M10 x 1,50

CTR6150L



Length [mm] : 65
Outer thread 1 [mm] : M12 x 1,25
Outer thread 2 [mm] : M12 x 1,25

CTR6150R



Length [mm] : 65
Outer thread 1 [mm] : M12 x 1,25
Outer thread 2 [mm] : M12 x 1,25

CTR6160



CTR6161



Length [mm] : 360,5
Outer thread 1 [mm] : M12 x 1,25
Outer thread 2 [mm] : M12 x 1,25

CTR6172



Length [mm] : 282
Thread Size : M10 x 1,50 mm

CTR6182L



CTR6182R



CTR6191



Length [mm] : 76
Thread Size : M10 x 1,5

CTR6211



MO5414



Height 1 [mm] : 24
Height 2 [mm] : 41
Inner Diameter [mm] : 17
Outer diameter [mm] : 60

MO5809



MO6180



Height [mm] : 53
Inner Diameter [mm] : 26
Outer diameter [mm] : 82

MO6848



RE014



Length [mm] : 324
Outer thread [mm] : M12 x 1,25

RE0185



RE030



Length [mm] : 330
Outer thread 1 [mm] : M14 x 1,50
Outer thread 2 [mm] : M14 x 1,50

PICTURES

RE033



Length [mm] : 342
Outer thread [mm] : M14 x 1,50

RE046



Length [mm] : 226.5
Outer thread 1 [mm] : M14 x 1,50
Outer thread 2 [mm] : M18 x 1,50

RE049



Length [mm] : 291.5
Outer thread 1 [mm] : M17 x 1,50
Outer thread 2 [mm] : M14 x 1,50

RE053



Length [mm] : 294
Outer thread 1 [mm] : M12 x 1,25
Outer thread 2 [mm] : M16 x 1,00

RE056



Inner Thread [mm] : M14 x 1,50
Outer thread [mm] : M12 x 1,50
Overall Length [mm] : 316.2

RE071



Length [mm] : 192.5
Outer thread 1 [mm] : M14 x 1,50
Outer thread 2 [mm] : M12 x 1,25

RE1609



RE188



Outer thread 1 [mm] : M14 x 1,50
Outer thread 2 [mm] : M15 x 1,50
Overall Length [mm] : 291

RE2406



RE5192



Length [mm] : 369
Outer thread [mm] : M14 x 1,50

RE5407



Length [mm] : 292
Outer thread [mm] : M14 x 2,00

RE5438



Length [mm] : 365
Outer thread [mm] : M14 x 1,50

RE5444



Length [mm] : 260.5
Outer thread 1 [mm] : M14 x 1,50
Outer thread 2 [mm] : M16 x 1,50

RE5450



Length [mm] : 305
Outer thread [mm] : M14 x 2,00

RE5463



RE5472



Inner Thread [mm] : M14 x 1,50
Length [mm] : 255.5

RE5473



Outer thread 1 [mm] : M14 x 1,50
Outer thread 2 [mm] : M14 x 1,50
Overall Length [mm] : 355,5

RE5489



Length [mm] : 227
Outer thread 1 [mm] : M14 x 1,50
Outer thread 2 [mm] : M18 x 1,50

RE5499



Inner Thread [mm] : M14 x 1,50
Length [mm] : 318
Outer thread [mm] : M12 x 1,50

RE5512



RE5547



Length [mm] : 280
Outer thread [mm] : M14 x 1,50

RE5549



Length [mm] : 194
Outer thread 1 [mm] : M16 x 1,00
Outer thread 2 [mm] : M18 x 1,50

RE5571



RE5604



Length [mm] : 228,5
Outer thread 1 [mm] : M14 x 1,50
Outer thread 2 [mm] : M18 x 1,50

RE5651



Inner Thread [mm] : M14 x 1,50
Outer thread [mm] : M14 x 1,50
Overall Length [mm] : 319,8

RE5712



RE5718



Outer thread 1 [mm] : M14 x 1,50
Outer thread 2 [mm] : M16 x 1,50
Overall Length [mm] : 310,2

RE5782



Outer thread 1 [mm] : M14 x 1,50
Outer thread 2 [mm] : M16 x 1,50
Overall Length [mm] : 256

RE5815



Outer thread 1 [mm] : M14 x 1,50
Outer thread 2 [mm] : M12 x 1,50
Overall Length [mm] : 298

RE5841



Outer thread 1 [mm] : M16 x 1,50
Outer thread 2 [mm] : M16 x 1,50
Overall Length [mm] : 328

RE5843



Outer thread 1 [mm] : M18 x 1,50
Outer thread 2 [mm] : M14 x 1,50
Overall Length [mm] : 261,3

RE5845



Length [mm] : 262
Outer thread 1 [mm] : M16 x 1,50
Outer thread 2 [mm] : M18 x 1,50

PICTURES

RE5870



Length [mm] : 315
Outer thread 1 [mm] : M14 x 1,50
Outer thread 2 [mm] : M14 x 1,50

RE5902



Outer thread [mm] : M14 x 1,50
Overall Length [mm] : 230.7
Thread Size : M14 x 1,50

RE5908



Length [mm] : 185.5
Outer thread 1 [mm] : M14 x 1,50
Outer thread 2 [mm] : M12 x 1,25

RE5928



Outer thread 1 [mm] : M18 x 1,50
Outer thread 2 [mm] : M16 x 1,50
Overall Length [mm] : 416

RE5946



Length [mm] : 309
Outer thread 1 [mm] : M17 x 1,50
Outer thread 2 [mm] : M14 x 1,50

RE5948



Length [mm] : 199
Outer thread 1 [mm] : M14 x 1,50
Outer thread 2 [mm] : M18 x 1,50

RE5957



Outer thread 1 [mm] : M14 x 1,50
Outer thread 2 [mm] : M15 x 1,50
Overall Length [mm] : 249,5

RE5975



Length [mm] : 307.3
Outer thread 1 [mm] : M16 x 1,50
Outer thread 2 [mm] : M14 x 1,50

RE5986



Length [mm] : 211
Outer thread 1 [mm] : M14 x 1,50
Outer thread 2 [mm] : M12 x 1,00

RE5990



Length [mm] : 215
Outer thread 1 [mm] : M12 x 1,25
Outer thread 2 [mm] : M14 x 1,50

RE6055



RE6092



Outer thread 1 [mm] : M14 x 1,50
Outer thread 2 [mm] : M14 x 1,50
Overall Length [mm] : 312,5

RE8143



Outer thread 1 [mm] : M14 x 1,50
Outer thread 2 [mm] : M16 x 1,50
Overall Length [mm] : 340.5

Control Arm-/Trailing Arm Bush	1.2 TFSI	12/2010 →; for vehicles with sports suspension	E		'E	'H	BS6417
Control Arm-/Trailing Arm Bush	1.2 TFSI, 1.4 TFSI, 1.6 TDI, 2.0 TDI, 2.0 TFSI quattro	for vehicles with off-road suspension, for vehicles with standard chassis	E		'E	'H	BS6417
Control Arm-/Trailing Arm Bush	1.6 TDI	07/2010 →; for vehicles with sports suspension	E		'E	'H	BS6417
Control Arm-/Trailing Arm Bush	1.6 TDI, 2.0 TDI	for vehicles with sports suspension	E		'E	'H	BS6417
Rod/Strut, stabiliser	1.2 TFSI, 1.4 TFSI, 1.6 TDI, 2.0 TDI, 2.0 TFSI quattro	Material: Steel	E		'E	'H	CTR5605
Top Strut Mounting	1.2 TFSI, 1.4 TFSI, 1.6 TDI, 2.0 TDI, 2.0 TFSI quattro	without ball bearing	E		'E	'H	MO6180

Control Arm-/Trailing Arm Bush	1.2 TFSI, 1.4 TFSI, 1.6 TDI, 2.0 TDI	for vehicles with off-road suspension, for vehicles with standard chassis	E		'E	'H	BS6417
Rod/Strut, stabiliser	1.2 TFSI, 1.4 TFSI, 1.6 TDI, 2.0 TDI	Material: Steel	E		'E	'H	CTR5605
Top Strut Mounting	1.2 TFSI, 1.4 TFSI, 1.6 TDI, 2.0 TDI	without ball bearing	E		'E	'H	MO6180

A2 (8Z0)

02/2000 → 08/2005

Rod/Strut, stabiliser	1.4, 1.4 TDI, 1.6 FSI	Material: Steel	E		'E	'H	CTR5605
-----------------------	-----------------------	-----------------	---	--	----	----	---------

A3 (8L1)

09/1996 → 05/2003

Control Arm-/Trailing Arm Bush	1.6, 1.8, 1.8 T, 1.8 T quattro, 1.9 TDI, 1.9 TDI quattro, S3 quattro		E		'E	'H	BS6417
Control Arm-/Trailing Arm Bush	1.6, 1.8, 1.8 T, 1.8 T quattro, 1.9 TDI, 1.9 TDI quattro	Material: Aluminium	E		'E		BS6883
Control Arm-/Trailing Arm Bush	1.6, 1.8, 1.8 T, 1.8 T quattro, 1.9 TDI, 1.9 TDI quattro	Material: Aluminium	E			'H	BS6884
Control Arm-/Trailing Arm Bush	1.6, 1.8, 1.8 T, 1.8 T quattro, 1.9 TDI, 1.9 TDI quattro, S3 quattro		E		'E	'H	BS6911
Repair Kit, ball joint	1.6, 1.8, 1.8 T, 1.8 T quattro, 1.9 TDI, 1.9 TDI quattro, S3 quattro		E		'E		CJ986
Repair Kit, ball joint	1.6, 1.8, 1.8 T, 1.8 T quattro, 1.9 TDI, 1.9 TDI quattro, S3 quattro		E			'H	CJ987
Tie Rod End	1.6, 1.8, 1.8 T, 1.8 T quattro, 1.9 TDI, 1.9 TDI quattro	ch.8L-W-050422→; 01/1998 →	E		'E		CTR5706L
Tie Rod End	1.6, 1.8, 1.8 T, 1.8 T quattro, 1.9 TDI, 1.9 TDI quattro	ch.8L-W-050422→; 01/1998 →	E			'H	CTR5706R
Top Strut Mounting	1.6, 1.8, 1.8 T, 1.8 T quattro, 1.9 TDI, 1.9 TDI quattro, S3 quattro	without ball bearing	E		'E	'H	MO6180
Tie Rod Axle Joint	1.6, 1.8, 1.8 T, 1.8 T quattro, 1.9 TDI, 1.9 TDI quattro	ch.8L-W-050422→; 01/1998 →	E		'E	'H	RE8143

A3 (8P1)

05/2003 → 08/2012

Control Arm-/Trailing Arm Bush	1.4 TFSI, 1.6, 1.6 FSI, 1.6 TDI, 1.8 T, 1.8 TFSI, 1.8 TFSI quattro, 1.9 TDI, 2.0, 2.0 FSI, 2.0 TDI, 2.0 TDI 16V, 2.0 TDI 16V quattro, 2.0 TDI quattro, 2.0 TFSI, 3.0 TFSI quattro, 3.2 V6 quattro, S3 quattro	Material: Aluminium	E	E		BS6883
Article Description				Fitting Position		
Control Arm-/Trailing Arm Bush A1 (8X1, 8XK)	1.4 TFSI, 1.6, 1.6 FSI, 1.6 TDI, 1.8 T, 1.8 TFSI, 1.8 TFSI quattro, 1.9 TDI, 2.0, 2.0 FSI, 2.0 TDI, 2.0 TDI 16V, 2.0 TDI 16V quattro, 2.0 TDI quattro, 2.0 TFSI, 2.0 TFSI quattro, 3.2 V6 quattro, S3 quattro	Material: Aluminium	E		05/2010 →	BS6884
Control Arm-/Trailing Arm Bush	1.2 TSI, 1.4 TFSI, 1.6, 1.6 E-Power, 1.6 FSI, 1.6 TDI, 1.8 T, 1.8 TFSI, 1.8 TFSI quattro, 1.9 TDI, 2.0, 2.0 FSI, 2.0 TDI, 2.0 TDI 16V, 2.0 TDI 16V quattro, 2.0 TDI quattro, 2.0 TFSI, 2.0 TFSI quattro, 3.2 V6 quattro, S3 quattro	Rubber-metal Bearing	E	E	H	BS6899
Rod/Strut, stabiliser	1.2 TSI, 1.4 TFSI, 1.6, 1.6 E-Power, 1.6 FSI, 1.6 TDI, 1.8 T, 1.8 TFSI, 1.8 TFSI quattro, 1.9 TDI, 2.0, 2.0 FSI, 2.0 TDI, 2.0 TDI 16V, 2.0 TDI 16V quattro, 2.0 TDI quattro, 2.0 TFSI quattro, 3.2 V6 quattro, S3 quattro	Material: Steel	E	E	H	CTR5849

A1 Sportback (8XA, 8XF)

09/2011 →

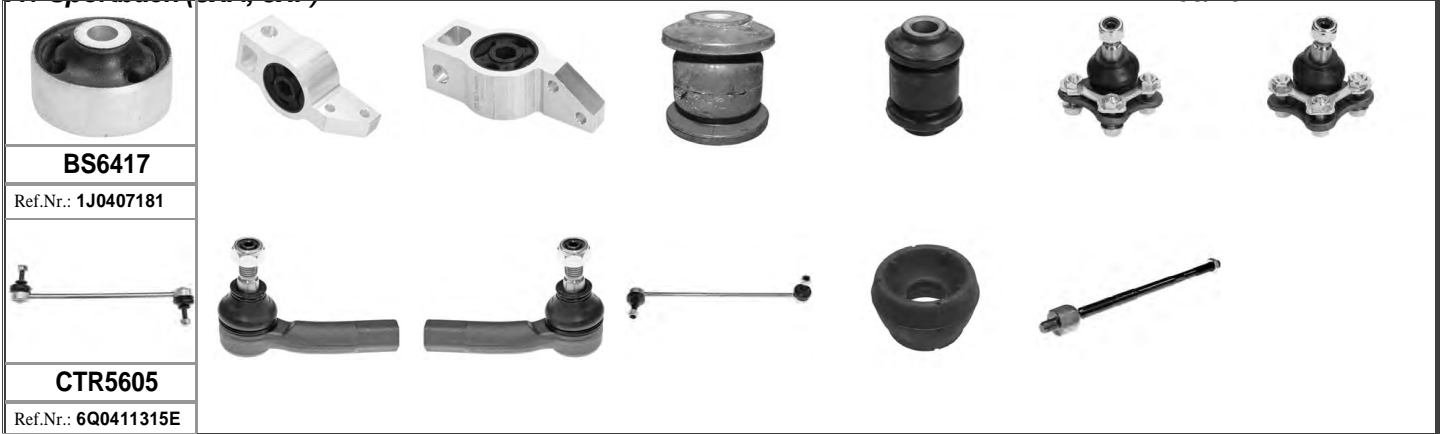

AUDI



Rod/Strut, stabiliser	2.0 TFSI	Engine Code: AXX; Material: Steel	E	E	H	CTR5849
Tie Rod Axle Joint	1.2 TSI, 1.4 TFSI, 1.6, 1.6 FSI, 1.6 E-Power, 1.6 TDI, 1.8 T, 1.8 TFSI, 1.8 TFSI quattro, 1.9 TDI, 2.0, 2.0 FSI, 2.0 TDI, 2.0 TDI 16V, 2.0 TDI 16V quattro, 2.0 TDI quattro, 2.0 TFSI, 2.0 TFSI quattro, 3.2 V6 quattro, S3 quattro		E	E	H	RE5841

Control Arm-/Trailing Arm Bush	1.6, 1.6 TDI, 1.8 TFSI, 1.9 TDI, 2.0 TDI, 2.0 TFSI	Material: Aluminium	E	E		BS6883
Control Arm-/Trailing Arm Bush	1.6, 1.6 TDI, 1.8 TFSI, 1.9 TDI, 2.0 TDI, 2.0 TFSI	Material: Aluminium	E		H	BS6884
Control Arm-/Trailing Arm Bush	1.2 TFSI, 1.4 TFSI, 1.6, 1.6 TDI, 1.8 TFSI, 1.9 TDI, 2.0 TDI, 2.0 TFSI	Rubber-metal Bearing	E	E	H	BS6899
Rod/Strut, stabiliser	1.2 TFSI, 1.6, 1.6 TDI, 1.8 TFSI, 1.9 TDI, 2.0 TDI, 2.0 TFSI	Material: Steel	E	E	H	CTR5849
Tie Rod Axle Joint	1.2 TFSI, 1.4 TFSI, 1.6, 1.6 TDI, 1.8 TFSI, 1.9 TDI, 2.0 TDI, 2.0 TFSI	for vehicles with electric power steering	E	E	H	RE5841







Control Arm-/Trailing Arm Bush	1.4 TFSI, 1.6, 1.6 FSI, 1.6 TDI, 1.8 TFSI, 1.8 TFSI quattro, 1.9 TDI, 2.0, 2.0 FSI, 2.0 TDI, 2.0 TDI 16V, 2.0 TDI 16V quattro, 2.0 TDI quattro, 2.0 TFSI, 2.0 TFSI quattro, 3.2 V6 quattro	Material: Aluminium	E	E		BS6883
Control Arm-/Trailing Arm Bush	1.4 TFSI, 1.6, 1.6 FSI, 1.6 TDI, 1.8 TFSI, 1.8 TFSI quattro, 1.9 TDI, 2.0, 2.0 FSI, 2.0 TDI, 2.0 TDI 16V, 2.0 TDI 16V quattro, 2.0 TDI quattro, 2.0 TFSI, 2.0 TFSI quattro, 3.2 V6 quattro	Material: Aluminium	E		H	BS6884
Control Arm-/Trailing Arm Bush	1.2 TSI, 1.4 TFSI, 1.6, 1.6 E-Power, 1.6 FSI, 1.6 TDI, 1.8 TFSI, 1.8 TFSI quattro, 1.9 TDI, 2.0, 2.0 FSI, 2.0 TDI, 2.0 TDI 16V, 2.0 TDI 16V quattro, 2.0 TDI quattro, 2.0 TFSI, 2.0 TFSI quattro, 3.2 V6 quattro, RS3 quattro, S3 quattro	Rubber-metal Bearing	E	E	H	BS6899
Rod/Strut, stabiliser	1.2 TSI, 1.4 TFSI, 1.6, 1.6 E-Power, 1.6 TDI, 1.8 TFSI, 1.8 TFSI quattro, 1.9 TDI, 2.0, 2.0 FSI, 2.0 TDI, 2.0 TDI 16V quattro, 2.0 TDI quattro, 2.0 TFSI quattro, S3 quattro	Material: Steel	E	E	H	CTR5849
Rod/Strut, stabiliser	Ref.Eng. 1K0199231J Ref.Nr.: 1K0199232J Ref.Eng. 1K0199232J Ref.Nr.: 1K0199231J	Material: Steel	E	E	H	CTR5849
Rod/Strut, stabiliser	2.0 FSI	Engine Code: BLF, BLX, BLY, BVY, BVZ; Material: Steel	E	E	H	CTR5849
Rod/Strut, stabiliser	2.0 TFSI	Engine Code: AXX; Material: Steel	E	E	H	CTR5849
Rod/Strut, stabiliser	3.2 V6 quattro	Engine Code: BMJ; Material: Steel	E	E	H	CTR5849
Tie Rod Axle Joint	1.2 TSI, 1.4 TFSI, 1.6 E-Power, 1.6 TDI, 1.6, 1.6 FSI, 1.8 TFSI quattro, 1.9 TDI, 2.0, 2.0 FSI, 2.0 TDI, 2.0 TDI 16V, 2.0 TDI 16V quattro, 2.0 TDI quattro, 2.0 TFSI, 2.0 TFSI quattro, 3.2 V6 quattro, RS3 quattro, S3 quattro	Material: Steel	E	E	H	RE5841
Rod/Strut, stabiliser	Ref.Eng. 1K0422807B Ref.Nr.: 1K0422807B Ref.Eng. 1K0422807B Ref.Nr.: 1K0422807B	Material: Steel	E	E	H	CTR5849
Rod/Strut, stabiliser	2.0 FSI	Engine Code: BLF, BLX, BLY, BVY, BVZ; Material: Steel	E	E	H	CTR5849
Rod/Strut, stabiliser	2.0 TFSI	Engine Code: AXX; Material: Steel	E	E	H	CTR5849
Rod/Strut, stabiliser	3.2 V6 quattro	Engine Code: BMJ; Material: Steel	E	E	H	CTR5849
Tie Rod Axle Joint	1.2 TSI, 1.4 TFSI, 1.6 E-Power, 1.6 TDI, 1.6, 1.6 FSI, 1.8 TFSI quattro, 1.9 TDI, 2.0, 2.0 FSI, 2.0 TDI, 2.0 TDI 16V, 2.0 TDI 16V quattro, 2.0 TDI quattro, 2.0 TFSI, 2.0 TFSI quattro, 3.2 V6 quattro, RS3 quattro, S3 quattro	Material: Steel	E	E	H	RE5841
Rod/Strut, stabiliser	Ref.Eng. 1K0411315G Ref.Nr.: 1K0411315G Ref.Eng. 1K0411315G Ref.Nr.: 1K0411315G	Material: Steel	E	E	H	CTR5849
Rod/Strut, stabiliser	2.0 FSI	Engine Code: BLF, BLX, BLY, BVY, BVZ; Material: Steel	E	E	H	CTR5849
Rod/Strut, stabiliser	2.0 TFSI	Engine Code: AXX; Material: Steel	E	E	H	CTR5849
Rod/Strut, stabiliser	3.2 V6 quattro	Engine Code: BMJ; Material: Steel	E	E	H	CTR5849
Tie Rod Axle Joint	1.2 TSI, 1.4 TFSI, 1.6 E-Power, 1.6 TDI, 1.6, 1.6 FSI, 1.8 TFSI quattro, 1.9 TDI, 2.0, 2.0 FSI, 2.0 TDI, 2.0 TDI 16V, 2.0 TDI 16V quattro, 2.0 TDI quattro, 2.0 TFSI, 2.0 TFSI quattro, 3.2 V6 quattro, RS3 quattro, S3 quattro	Material: Steel	E	E	H	RE5841

A3 (8V1, 8VK)

04/2012 →

Tie Rod Axle Joint	1.4 TFSI, 1.6 TDI, 1.8 TFSI, 1.8 TFSI quattro, 2.0 TDI, 2.0 TDI quattro		E	E	H	RE5841
Article A4 (8D2) (B5)			Fitting 09/2004 → 09/2001			
Control Arm-/Trailing Arm Bush	1.6, 1.8, 1.8 quattro, 1.8 T, 1.8 T quattro, 1.9 TDI, 1.9 TDI quattro, 2.4, 2.4 quattro, 2.5 TDI, 2.5 TDI quattro, 2.6, 2.6 quattro, 2.8, 2.8 quattro, S4 quattro	Rubber-metal Bearing	E	E	H	BS7069
Control Arm-/Trailing Arm Bush	1.6, 1.8, 1.8 quattro, 1.8 T, 1.8 T quattro, 1.9 TDI, 1.9 TDI quattro, 2.4, 2.4 quattro, 2.5 TDI, 2.5 TDI quattro, 2.6, 2.6 quattro, 2.8, 2.8 quattro, S4 quattro		E	E	H	BS7072
Track Control Arm	1.6, 1.8, 1.8 quattro, 1.8 T, 1.8 T quattro, 1.9 TDI, 1.9 TDI quattro, 2.4, 2.4 quattro, 2.5 TDI, 2.5 TDI quattro, 2.6, 2.6 quattro, 2.8, 2.8 quattro, S4 quattro		E		H	CJ1033
A3 Convertible (8P7)						04/2008 →

AUDI

					
BS6883					
A3 Sportback (8PA)					09/2004 → 03/2013
					
RE5841					
Ref.Nr.: 1K0423810A					

BS6884 Ref.Nr.: 1K0199232J	BS6899 Ref.Nr.: 1K0407182	BS7069 Ref.Nr.: 4D0407183P	BS7072 Ref.Nr.: 4D0407515	CJ1033 Ref.Nr.: 8D0407506H	CTR5849 Ref.Nr.: 1K0411315G
--------------------------------------	-------------------------------------	--------------------------------------	-------------------------------------	--------------------------------------	---------------------------------------

Article Description			Fitting Position	Article No.
---------------------	---	---	------------------	-------------

A4 (8D2, B5)











11/1994 → 09/2001

Track Control Arm	1.6, 1.8, 1.8 quattro, 1.8 T, 1.8 T quattro, 1.9 TDI, 1.9 TDI quattro, 2.4, 2.4 quattro, 2.5 TDI, 2.5 TDI quattro, 2.6, 2.6 quattro, 2.8, 2.8 quattro, S4 quattro		E	'E		CJ1034
Track Control Arm	1.6, 1.8, 1.8 quattro, 1.8 T, 1.8 T quattro, 1.9 TDI, 1.9 TDI quattro, 2.4, 2.4 quattro, 2.5 TDI, 2.5 TDI quattro, 2.6, 2.6 quattro, 2.8, 2.8 quattro, S4 quattro	ch.→8DV152087	E		'H	CJ1035
Track Control Arm	2.4		E	'E	'H	CJ1175
Track Control Arm	1.6, 1.8 quattro, 1.8 T, 1.8 T quattro, 1.9 TDI, 1.9 TDI quattro, 2.4, 2.4 quattro, 2.5 TDI, 2.5 TDI quattro, 2.6, 2.6 quattro, 2.8, 2.8 quattro, S4 quattro	for OE: 8D0407505B	E	'E		CJ287
Track Control Arm	1.8, 1.8 quattro, 2.4, 2.4 quattro		E	'E		CJ287
Track Control Arm	1.6, 1.8, 1.8 quattro, 1.8 T, 1.8 T quattro, 1.9 TDI, 1.9 TDI quattro, 2.4, 2.4 quattro, 2.5 TDI, 2.5 TDI quattro, 2.6, 2.6 quattro, 2.7 Bi Turbo quattro, 2.7 Turbo quattro, 2.8, 2.8 24V, 2.8 quattro, S4 quattro		E	'E		CJ292
Track Control Arm	1.6, 1.8, 1.8 quattro, 1.8 T, 1.8 T quattro, 1.9 TDI, 1.9 TDI quattro, 2.4, 2.4 quattro, 2.5 TDI, 2.5 TDI quattro, 2.6, 2.6 quattro, 2.7 Bi Turbo quattro, 2.7 Turbo quattro, 2.8, 2.8 24V, 2.8 quattro, S4 quattro		E		'H	CJ293
Tie Rod End	1.6, 1.8, 1.8 quattro, 1.8 T, 1.8 T quattro, 1.9 TDI, 1.9 TDI quattro, 2.4, 2.4 quattro, 2.5 TDI, 2.5 TDI quattro, 2.6, 2.6 quattro, 2.7 Bi Turbo quattro, 2.7 Turbo quattro, 2.8, 2.8 24V, 2.8 quattro	ch.→8D-X-303809; → 05/1999; for left-hand drive vehicles; with screw	E	'E	'H	CTR5491
Tie Rod End	1.6, 1.8, 1.8 quattro, 1.8 T, 1.8 T quattro, 1.9 TDI, 1.9 TDI quattro, 2.4, 2.4 quattro, 2.5 TDI, 2.5 TDI quattro, 2.6, 2.6 quattro, 2.7 Bi Turbo quattro, 2.7 Turbo quattro, 2.8, 2.8 24V, 2.8 quattro	ch.→8D-Y-005048; → 07/1999; for right-hand drive vehicles; with screw	E	'E	'H	CTR5491
Tie Rod End	1.6, 1.8, 1.8 quattro, 1.8 T, 1.8 T quattro, 1.9 TDI, 1.9 TDI quattro, 2.4, 2.4 quattro, 2.5 TDI, 2.5 TDI quattro, 2.6, 2.6 quattro, 2.7 Bi Turbo quattro, 2.7 Turbo quattro, 2.8, 2.8 24V, 2.8 quattro	ch.8D-X-303810→; 05/1999 →; for left-hand drive vehicles; not for equipment variant: S-LINE; not for PR: 1BV; with screw; for vehicles without lowered chassis	E	'E	'H	CTR5491
Tie Rod End	1.6, 1.8, 1.8 quattro, 1.8 T, 1.8 T quattro, 1.9 TDI, 1.9 TDI quattro, 2.4, 2.4 quattro, 2.5 TDI, 2.5 TDI quattro, 2.6, 2.6 quattro, 2.7 Bi Turbo quattro, 2.7 Turbo quattro, 2.8, 2.8 24V, 2.8 quattro	ch.8D-Y-005049→; 07/1999 →; for right-hand drive vehicles; not for equipment variant: S-LINE; not for PR: 1BV; with screw; for vehicles without lowered chassis	E	'E	'H	CTR5491
Tie Rod End	1.6, 1.8, 1.9 TDI, 1.9 TDI quattro	not for equipment variant: S-LINE; not for PR: 1BV; with screw; for vehicles without lowered chassis	E	'E	'H	CTR5491
Tie Rod End	1.8 T quattro [AJL]	ch.→8D-X-199999; → 12/1998; with screw	E	'E	'H	CTR5491

A4 Avant (8D5, B5)

11/1994 → 09/2001

Control Arm-/Trailing Arm Bush	1.6, 1.8, 1.8 quattro, 1.8 T, 1.8 T quattro, 1.9 TDI, 1.9 TDI quattro, 2.4, 2.4 quattro, 2.5 TDI, 2.5 TDI quattro, 2.6, 2.6 quattro, 2.8, 2.8 quattro, S4 quattro	Rubber-metal Bearing	E	'E	'H	BS7069
Control Arm-/Trailing Arm Bush	1.6, 1.8, 1.8 quattro, 1.8 T, 1.8 T quattro, 1.9 DUO, 1.9 TDI, 1.9 TDI quattro, 2.4, 2.4 quattro, 2.5 TDI, 2.5 TDI quattro, 2.6, 2.6 quattro, 2.8, 2.8 quattro, RS4 quattro, S4 quattro		E	'E	'H	BS7072
Track Control Arm	1.6, 1.8, 1.8 quattro, 1.8 T, 1.8 T quattro, 1.9 DUO, 1.9 TDI, 1.9 TDI quattro, 2.4, 2.4 quattro, 2.5 TDI, 2.5 TDI quattro, 2.6, 2.6 quattro, 2.8, 2.8 quattro, RS4 quattro, S4 quattro		E		'H	CJ1033
Track Control Arm	1.6, 1.8, 1.8 quattro, 1.8 T, 1.8 T quattro, 1.9 TDI, 1.9 TDI quattro, 2.4, 2.4 quattro, 2.5 TDI, 2.5 TDI quattro, 2.6, 2.6 quattro, 2.8, 2.8 quattro, RS4 quattro, S4 quattro		E	'E		CJ1034
Track Control Arm	1.6, 1.8, 1.8 quattro, 1.8 T, 1.8 T quattro, 1.9 TDI, 1.9 TDI quattro, 2.4, 2.4 quattro, 2.5 TDI, 2.5 TDI quattro, 2.6, 2.6 quattro, 2.8, 2.8 quattro, RS4 quattro, S4 quattro	ch.→8DV152087	E		'H	CJ1035
Track Control Arm	2.4		E	'E	'H	CJ1175

						
BS7069	BS7072	CJ1033	CJ1034	CJ1035	CJ1175	CJ287
Ref.Nr.: 4D0407183P	Ref.Nr.: 4D0407515	Ref.Nr.: 8D0407506H	Ref.Nr.: 4D0407509K	Ref.Nr.: 4D0407510B	Ref.Nr.: 8E0407151L	Ref.Nr.: 8D0407505B
						
CJ292	CJ293	CTR5491				
Ref.Nr.: 4D0407693E	Ref.Nr.: 4D0407694K	Ref.Nr.: 4B0419811B				

AUDI

Article Description			Fitting Position	Article No.
---------------------	---	---	------------------	-------------

A4 Avant (8D5, B5)









11/1994 → 09/2001

Track Control Arm	1.6, 1.8, 1.8 quattro, 1.8T, 1.8T quattro, 1.9TDI, 1.9TDI quattro, 2.4, 2.4 quattro, 2.5 TDI, 2.5 TDI quattro, 2.6, 2.6 quattro, 2.8, 2.8 quattro, RS4 quattro, S4 quattro	for OE: 8D0407505B	E	E		CJ287
Track Control Arm	1.8, 1.8 quattro, 1.9 DUO, 2.4, 2.4 quattro		E	E		CJ287
Track Control Arm	1.6, 1.8, 1.8 quattro, 1.8T, 1.8T quattro, 1.9DUO, 1.9TDI, 1.9TDI quattro, 2.4, 2.4 quattro, 2.5 TDI, 2.5 TDI quattro, 2.6, 2.6 quattro, 2.8, 2.8 quattro, RS4 quattro, S4 quattro		E	E		CJ292
Track Control Arm	1.6, 1.8, 1.8 quattro, 1.8T, 1.8T quattro, 1.9DUO, 1.9TDI, 1.9TDI quattro, 2.4, 2.4 quattro, 2.5 TDI, 2.5 TDI quattro, 2.6, 2.6 quattro, 2.8, 2.8 quattro, RS4 quattro, S4 quattro		E		H	CJ293
Tie Rod End	1.6, 1.8, 1.8 quattro, 1.8T, 1.8T quattro, 1.9DUO, 1.9TDI, 1.9TDI quattro, 2.4, 2.4 quattro, 2.5 TDI, 2.5 TDI quattro, 2.6, 2.6 quattro, 2.8, 2.8 quattro	ch.→8D-X-303809; → 05/1999; for left-hand drive vehicles; with screw	E	E	H	CTR5491
Tie Rod End	1.6, 1.8, 1.8 quattro, 1.8T, 1.8T quattro, 1.9DUO, 1.9TDI, 1.9TDI quattro, 2.4, 2.4 quattro, 2.5 TDI, 2.5 TDI quattro, 2.6, 2.6 quattro, 2.8, 2.8 quattro	ch.→8D-Y-005048; → 07/1999; for right-hand drive vehicles; with screw	E	E	H	CTR5491
Tie Rod End	1.6, 1.8, 1.8 quattro, 1.8T, 1.8T quattro, 1.9DUO, 1.9TDI, 1.9TDI quattro, 2.4, 2.4 quattro, 2.5 TDI, 2.5 TDI quattro, 2.6, 2.6 quattro, 2.8, 2.8 quattro	ch.8D-X-303810→; 05/1999 →; for left-hand drive vehicles; not for equipment variant: S-LINE; not for PR: 1BV; with screw; for vehicles without lowered chassis	E	E	H	CTR5491
Tie Rod End	1.6, 1.8, 1.8 quattro, 1.8T, 1.8T quattro, 1.9DUO, 1.9TDI, 1.9TDI quattro, 2.4, 2.4 quattro, 2.5 TDI, 2.5 TDI quattro, 2.6, 2.6 quattro, 2.8, 2.8 quattro	ch.8D-Y-005049→; 07/1999 →; for right-hand drive vehicles; not for equipment variant: S-LINE; not for PR: 1BV; with screw; for vehicles without lowered chassis	E	E	H	CTR5491
Tie Rod End	1.6, 1.9 TDI, 1.9 TDI quattro	not for equipment variant: S-LINE; not for PR: 1BV; with screw; for vehicles without lowered chassis	E	E	H	CTR5491
Tie Rod End	1.8 T quattro [AJL]	ch.→8D-X-199999; → 12/1998; with screw	E	E	H	CTR5491

A4 (8E2, B6)

11/2000 → 12/2004

Control Arm-/Trailing Arm Bush	1.8T, 1.8T quattro, 1.9TDI, 2.0, 2.5 TDI quattro, 3.0, 3.0 quattro		E	E	H	BS7072
Track Control Arm	1.8T, 1.8T quattro, 1.9TDI, 2.0, 2.5 TDI quattro, 3.0, 3.0 quattro		E		H	CJ1033
Track Control Arm	1.6, 1.8T, 1.8 T quattro, 1.9 TDI, 2.0, 2.5 TDI quattro, 3.0, 3.0 quattro		E	E		CJ1034
Track Control Arm	1.6, 1.8T, 1.8 T quattro, 1.9 TDI, 2.0, 2.5 TDI quattro, 3.0, 3.0 quattro		E		H	CJ1035
Track Control Arm	1.6, 1.8T, 1.8 T quattro, 1.9 TDI, 1.9 TDI quattro, 2.0, 2.0 FSI, 2.4, 2.5 TDI, 2.5 TDI quattro, 3.0, 3.0 quattro, S4 quattro		E	E	H	CJ1175
Track Control Arm	1.8T, 1.8T quattro, 1.9TDI, 2.0, 2.5 TDI quattro, 3.0, 3.0 quattro		E	E		CJ287
Track Control Arm	1.6, 1.8T, 1.8 T quattro, 1.9 TDI, 1.9 TDI quattro, 2.0, 2.0 FSI, 2.4, 2.5 TDI, 2.5 TDI quattro, 3.0, 3.0 quattro		E	E		CJ292
Track Control Arm	1.6, 1.8T, 1.8 T quattro, 1.9 TDI, 1.9 TDI quattro, 2.0, 2.0 FSI, 2.4, 2.5 TDI, 2.5 TDI quattro, 3.0, 3.0 quattro		E		H	CJ293
Tie Rod End	1.6, 1.8T, 1.8 T quattro, 1.9 TDI, 1.9 TDI quattro, 2.0, 2.0 FSI, 2.4, 2.5 TDI, 2.5 TDI quattro, 3.0, 3.0 quattro	for PR: 1BA; with screw; for vehicles with standard chassis	E	E	H	CTR5491
Tie Rod End	1.6, 1.8T, 1.8 T quattro, 1.9 TDI, 1.9 TDI quattro, 2.0, 2.0 FSI, 2.4, 2.5 TDI, 2.5 TDI quattro, 3.0, 3.0 quattro	for PR: 1BD; with screw; for vehicles with lowered chassis, for vehicles with sports suspension	E	E	H	CTR5491
Tie Rod End	1.6, 1.8T, 1.8 T quattro, 1.9 TDI, 1.9 TDI quattro, 2.0, 2.0 FSI, 2.4, 2.5 TDI, 2.5 TDI quattro, 3.0, 3.0 quattro	for PR: 1BE; with screw; for vehicles with lowered chassis, for vehicles with sports suspension	E	E	H	CTR5491
Tie Rod End	1.6, 1.8T, 1.8 T quattro, 1.9 TDI, 1.9 TDI quattro, 2.0, 2.0 FSI, 2.4, 2.5 TDI, 2.5 TDI quattro, 3.0, 3.0 quattro	for PR: 1BR; with screw; for vehicles with comfort suspension, for vehicles with off-road suspension	E	E	H	CTR5491
Tie Rod End	1.6, 1.8T, 1.8 T quattro, 1.9 TDI, 1.9 TDI quattro, 2.0, 2.0 FSI, 2.4, 2.5 TDI, 2.5 TDI quattro, 3.0, 3.0 quattro	not for equipment variant: S-LINE; not for PR: 1BV; with screw; for vehicles without lowered chassis, for vehicles without sports suspension	E	E	H	CTR5491

						
BS7072	CJ1033	CJ1034	CJ1035	CJ1175	CJ287	CJ292
Ref.Nr.: 4D0407515	Ref.Nr.: 8D0407506H	Ref.Nr.: 4D0407509K	Ref.Nr.: 4D0407510B	Ref.Nr.: 8E0407151L	Ref.Nr.: 8D0407505B	Ref.Nr.: 4D0407693E
						
CJ293	CTR5491					
Ref.Nr.: 4D0407694K	Ref.Nr.: 4B0419811B					

Article Description			Fitting Position	Article No.
---------------------	---	---	------------------	-------------

A4 Avant (8E5, B6)

10/2000 → 12/2004

Track Control Arm	1.6, 1.8 T, 1.8 T quattro, 1.9 TDI, 1.9 TDI quattro, 2.0, 2.0 FSI, 2.4, 2.5 TDI, 2.5 TDI quattro, 3.0, 3.0 quattro, S4 quattro		E	'E	'H	CJ1175
Track Control Arm	1.6, 1.8 T, 1.8 T quattro, 1.9 TDI, 1.9 TDI quattro, 2.0, 2.0 FSI, 2.4, 2.5 TDi, 2.5 TDI quattro, 3.0, 3.0 quattro		E	'E		CJ292
Track Control Arm	1.6, 1.8 T, 1.8 T quattro, 1.9 TDI, 1.9 TDI quattro, 2.0, 2.0 FSI, 2.4, 2.5 TDi, 2.5 TDI quattro, 3.0, 3.0 quattro		E		'H	CJ293
Tie Rod End	1.6, 1.8 T, 1.8 T quattro, 1.9 TDI, 1.9 TDI quattro, 2.0, 2.0 FSI, 2.4, 2.5 TDI, 2.5 TDI quattro, 3.0, 3.0 quattro	for PR: 1BA; with screw; for vehicles with standard chassis	E	'E	'H	CTR5491
Tie Rod End	1.6, 1.8 T, 1.8 T quattro, 1.9 TDI, 1.9 TDI quattro, 2.0, 2.0 FSI, 2.4, 2.5 TDI, 2.5 TDI quattro, 3.0, 3.0 quattro	for PR: 1BD; with screw; for vehicles with lowered chassis, for vehicles with sports suspension	E	'E	'H	CTR5491
Tie Rod End	1.6, 1.8 T, 1.8 T quattro, 1.9 TDI, 1.9 TDI quattro, 2.0, 2.0 FSI, 2.4, 2.5 TDI, 2.5 TDI quattro, 3.0, 3.0 quattro	for PR: 1BE; with screw; for vehicles with lowered chassis, for vehicles with sports suspension	E	'E	'H	CTR5491
Tie Rod End	1.6, 1.8 T, 1.8 T quattro, 1.9 TDI, 1.9 TDI quattro, 2.0, 2.0 FSI, 2.4, 2.5 TDI, 2.5 TDI quattro, 3.0, 3.0 quattro	for PR: 1BR; with screw; for vehicles with comfort suspension, for vehicles with off-road suspension	E	'E	'H	CTR5491
Tie Rod End	1.6, 1.8 T, 1.8 T quattro, 1.9 TDI, 1.9 TDI quattro, 2.0, 2.0 FSI, 2.4, 2.5 TDI, 2.5 TDI quattro, 3.0, 3.0 quattro	not for equipment variant: S-LINE; not for PR: 1BV; with screw; for vehicles without lowered chassis, for vehicles without sports suspension	E	'E	'H	CTR5491

A4 (8EC, B7)

11/2004 → 06/2008

Track Control Arm	1.8 T, 1.8 T quattro, 2.0 TDI, 2.0 TDI 16V		E	'E	'H	CJ1175
-------------------	--	--	---	----	----	--------

A4 Avant (8ED, B7)

11/2004 → 06/2008

Track Control Arm	1.8 T, 1.8 T quattro, 2.0 TDI, 2.0 TDI 16V		E	'E	'H	CJ1175
-------------------	--	--	---	----	----	--------

A4 Convertible (8H7, B6, 8HE, B7)









04/2002 → 03/2009

Track Control Arm	1.8 T, 1.8 T quattro, 2.0, 2.4, 2.5 TDI, 3.0, 3.0 quattro, S4 quattro		E	'E	'H	CJ1175
Track Control Arm	1.8, 1.8 T, 1.8 T quattro, 2.0, 2.0 TFSi quattro, 2.4, 2.5 TDI, 3.0, 3.0 quattro	ch.→8H-6-025 000; → 12/2005	E	'E		CJ292
Track Control Arm	S4 quattro	ch.→8H-6-905 000; → 12/2005	E	'E		CJ292
Track Control Arm	1.8, 1.8 T, 1.8 T quattro, 2.0, 2.0 TFSi quattro, 2.4, 2.5 TDI, 3.0, 3.0 quattro	ch.→8H-6-025 000; → 12/2005	E		'H	CJ293
Track Control Arm	S4 quattro	ch.→8H-6-905 000; → 12/2005	E		'H	CJ293
Tie Rod End	1.8, 1.8 T, 1.8 T quattro, 2.0, 2.4, 2.5 TDI, 3.0, 3.0 quattro	ch.→8H-5-014476; → 11/2004; with screw	E	'E	'H	CTR5491

A6 (4B2, C5)

01/1997 → 01/2005

Control Arm-/Trailing Arm Bush	1.8, 1.8 T, 1.8 T quattro, 1.9 TDI, 2.4, 2.4 quattro, 2.5 TDI, 2.5 TDI quattro, 2.7 T quattro, 2.8, 2.8 quattro	Rubber-metal Bearing; 01/1998 →	E	'E	'H	BS7069
Control Arm-/Trailing Arm Bush	2.7 T	Rubber-metal Bearing	E	'E	'H	BS7069
Control Arm-/Trailing Arm Bush	1.8 T, 1.8 T quattro, 2.4, 2.4 quattro, 2.5 TDI, 2.5 TDI quattro, 2.7 T quattro, 2.8 quattro, 3.7, 3.7 quattro, 4.2 quattro, S6 quattro	for OE: 8D0407505B	E	'E	'H	BS7072
Control Arm-/Trailing Arm Bush	1.8, 1.8 T quattro, 1.9 TDI, 2.7 T, 2.8		E	'E	'H	BS7072
Control Arm-/Trailing Arm Bush	1.8, 1.8 T, 1.9 TDI, 2.4, 2.5 TDI, 2.8	01/1998 →	E	'E	'H	BS7072
Track Control Arm	1.8, 1.8 T, 1.8 T quattro, 1.9 TDI, 2.4, 2.4 quattro, 2.5 TDI, 2.5 TDI quattro, 2.7 T, 2.7 T quattro, 2.8, 2.8 quattro, 3.7, 3.7 quattro, 4.2 quattro, S6 quattro		E		'H	CJ1033
Track Control Arm	1.8, 1.8 T, 1.8 T quattro, 1.9 TDI, 2.4, 2.4 quattro, 2.5 TDI, 2.5 TDI quattro, 2.7 T, 2.7 T quattro, 2.8, 2.8 quattro, 3.7, 3.7 quattro, 4.2 quattro, S6 quattro	for OE: 8D0407505B	E	'E		CJ287

						
BS7069	BS7072	CJ1033	CJ1175	CJ287	CJ292	CJ293
Ref.Nr.: 4D0407183P	Ref.Nr.: 4D0407515	Ref.Nr.: 8D0407506H	Ref.Nr.: 8E0407151L	Ref.Nr.: 8D0407505B	Ref.Nr.: 4D0407693E	Ref.Nr.: 4D0407694K
						
CTR5491						
Ref.Nr.: 4B0419811B						

Article Description			Fitting Position	Article No.
---------------------	---	---	------------------	-------------

A6 (4B2, C5)

01/1997 → 01/2005

Track Control Arm	1.8, 1.8 T, 1.8 T quattro, 1.9 TDI, 2.0, 2.4, 2.4 quattro, 2.5 TDI, 2.5 TDI quattro, 2.7, 2.7 quattro, 2.7 T, 2.7 T quattro, 2.8, 2.8 quattro, 3.0, 3.0 quattro, 3.7, 3.7 quattro, 4.2 quattro, RS6 quattro, S6 quattro		E	E			CJ292
Track Control Arm	1.8, 1.8 T, 1.8 T quattro, 1.9 TDI, 2.0, 2.4, 2.4 quattro, 2.5 TDI, 2.5 TDI quattro, 2.7, 2.7 quattro, 2.7 T, 2.7 T quattro, 2.8, 2.8 quattro, 3.0, 3.0 quattro, 3.7, 3.7 quattro, 4.2 quattro, RS6 quattro, S6 quattro		E			H	CJ293
Tie Rod End	1.8, 1.8 T, 1.8 T quattro, 1.9 TDI, 2.4, 2.4 quattro, 2.5 TDI, 2.5 TDI quattro, 2.7 T, 2.7 T quattro, 2.8, 2.8 quattro, 3.7, 3.7 quattro, 4.2 quattro	ch.→4B-1-200000; → 04/2001; with screw	E		E	H	CTR5491

A6 Avant (4B5, C5)









12/1997 → 01/2005



Control Arm-/Trailing Arm Bush	1.8, 1.8 T, 1.8 T quattro, 1.9 TDI, 2.4, 2.4 quattro, 2.5 TDI, 2.5 TDI quattro, 2.7 T quattro, 2.8, 2.8 quattro	Rubber-metal Bearing; 01/1998 →	E		E	H	BS7069
Control Arm-/Trailing Arm Bush	2.7 T	Rubber-metal Bearing	E		E	H	BS7069
Control Arm-/Trailing Arm Bush	1.8 T quattro, 2.4 quattro, 2.5 TDI quattro, 2.7 T quattro, 2.8 quattro	ch.4B-W-180001→; 01/1998 →	E		E	H	BS7072
Control Arm-/Trailing Arm Bush	1.8 T, 1.8 T quattro, 2.4, 2.5 TDI, 2.5 TDI quattro, 3.7, 3.7 quattro, 4.2 quattro, S6 quattro	for OE: 8D0407505B	E		E	H	BS7072
Control Arm-/Trailing Arm Bush	1.8, 1.8 T, 1.9 TDI, 2.4, 2.5 TDI, 2.8	01/1998 →	E		E	H	BS7072
Control Arm-/Trailing Arm Bush	1.8, 1.9 TDI, 2.7 T, 2.8		E		E	H	BS7072
Track Control Arm	1.8, 1.8 T, 1.8 T quattro, 1.9 TDI, 2.4, 2.4 quattro, 2.5 TDI, 2.5 TDI quattro, 2.7 T, 2.7 T quattro, 2.8, 2.8 quattro, 3.7, 3.7 quattro, 4.2 quattro, S6 quattro		E			H	CJ1033
Track Control Arm	1.8, 1.8 T, 1.8 T quattro, 1.9 TDI, 2.4, 2.4 quattro, 2.5 TDI, 2.5 TDI quattro, 2.7 T, 2.7 T quattro, 2.8, 2.8 quattro, 3.7, 3.7 quattro, 4.2 quattro, S6 quattro	for OE: 8D0407505B	E		E		CJ287
Track Control Arm	1.8, 1.8 T, 1.8 T quattro, 1.9 TDI, 2.0, 2.4, 2.4 quattro, 2.5 TDI, 2.5 TDI quattro, 2.7 T, 2.7 T quattro, 2.8, 2.8 quattro, 3.0, 3.0 quattro, 3.7, 3.7 quattro, 4.2 quattro, RS6 plus quattro, RS6 quattro, S6 quattro		E		E		CJ292
Track Control Arm	1.8, 1.8 T, 1.8 T quattro, 1.9 TDI, 2.0, 2.4, 2.4 quattro, 2.5 TDI, 2.5 TDI quattro, 2.7 T, 2.7 T quattro, 2.8, 2.8 quattro, 3.0, 3.0 quattro, 3.7, 3.7 quattro, 4.2 quattro, RS6 plus quattro, RS6 quattro, S6 quattro		E			H	CJ293
Tie Rod End	1.8, 1.8 T, 1.8 T quattro, 1.9 TDI, 2.4, 2.4 quattro, 2.5 TDI, 2.5 TDI quattro, 2.7 T, 2.7 T quattro, 2.8, 2.8 quattro, 3.7, 3.7 quattro, 4.2 quattro	ch.→4B-1-200000; → 04/2001; with screw	E		E	H	CTR5491

A8 (4D2, 4D8)









03/1994 → 09/2002

Control Arm-/Trailing Arm Bush	2.5 TDI, 2.5 TDI quattro, 2.8, 2.8 quattro, 3.7, 3.7 quattro, 4.2 quattro, S 8 quattro	Rubber-metal Bearing	E		E	H	BS7069
Control Arm-/Trailing Arm Bush	2.5 TDI, 2.5 TDI quattro, 2.8, 2.8 quattro, 3.3 TDI quattro, 3.7, 3.7 quattro, 4.2 quattro, S 8 quattro	for OE: 4D0407505B	E		E	H	BS7072
Track Control Arm	2.5 TDI, 2.5 TDI quattro, 2.8, 2.8 quattro, 3.3 TDI quattro, 3.7, 3.7 quattro, 4.2 quattro, S 8 quattro		E			H	CJ1033
Track Control Arm	2.5 TDI, 2.5 TDI quattro, 2.8, 2.8 quattro, 3.3 TDI quattro, 3.7, 3.7 quattro, 4.2 quattro, 6.0 W12 quattro, S 8 quattro		E		E		CJ1034
Track Control Arm	2.5 TDI, 2.5 TDI quattro, 2.8, 2.8 quattro, 3.3 TDI quattro, 3.7, 3.7 quattro, 4.2 quattro, 6.0 W12 quattro, S 8 quattro	ch.→4D-X-004999; → 12/1998	E			H	CJ1035
Track Control Arm	2.5 TDI, 2.5 TDI quattro, 2.8, 2.8 quattro, 3.3 TDI quattro, 3.7, 3.7 quattro, 4.2 quattro, S 8 quattro	for OE: 4D0407505B	E		E		CJ287
Track Control Arm	2.5 TDI, 2.5 TDI quattro, 2.8 quattro, 3.3 TDI quattro, 3.7, 3.7 quattro, 4.2 quattro, 6.0 W12 quattro, S 8 quattro	→ 12/1998	E		E		CJ292

						
BS7069	BS7072	CJ1033	CJ1034	CJ1035	CJ287	CJ292
Ref.Nr.: 4D0407183P	Ref.Nr.: 4D0407515	Ref.Nr.: 8D0407506H	Ref.Nr.: 4D0407509K	Ref.Nr.: 4D0407510B	Ref.Nr.: 8D0407505B	Ref.Nr.: 4D0407693E
						
CJ293	CTR5491					
Ref.Nr.: 4D0407694K	Ref.Nr.: 4B0419811B					

Article Description			Fitting Position	Article No.	
A8 (4D2, 4D8)				03/1994 → 09/2002	
Track Control Arm	2.5 TDI, 2.5 TDI quattro, 2.8 quattro, 3.3 TDI quattro, 3.7, 3.7 quattro, 4.2 quattro, 6.0 W12 quattro, S 8 quattro	→ 12/1998	E	'H	CJ293
Tie Rod End	2.5 TDI, 2.5 TDI quattro, 2.8, 2.8 quattro, 3.3 TDI quattro, 3.7, 3.7 quattro, 4.2 quattro, 6.0 W12 quattro, S 8 quattro	not for armoured vehicles; with screw	E	'E 'H	CTR5491
ALLROAD (4BH, C5)				05/2000 → 08/2005	
Tie Rod End	2.5 TDI quattro, 2.7 quattro, 2.7 T quattro	ch.→4B-2-150000; → 06/2002; with screw	E	'E 'H	CTR5491
Q3 (8U)				06/2011 →	
Control Arm-/Trailing Arm Bush	2.0 TDI, 2.0 TDI quattro, 2.0 TFSI quattro	Rubber-metal Bearing	E	'E 'H	BS6899
Rod/Strut, stabiliser	2.0 TDI, 2.0 TDI quattro, 2.0 TFSI quattro	Material: Steel	E	'E 'H	CTR5849
Tie Rod Axle Joint	2.0 TDI, 2.0 TDI quattro, 2.0 TFSI quattro	for vehicles with electric power steering	E	'E 'H	RE5841
TT (8N3)				10/1998 → 06/2006	
Control Arm-/Trailing Arm Bush	1.8 T, 1.8 T quattro		E	'E 'H	BS6417
Control Arm-/Trailing Arm Bush	1.8 T, 1.8 T quattro	ch.→8N-Y-060000	E	'E 'H	BS6911
Top Strut Mounting	1.8 T, 1.8 T quattro, 3.2 VR6 quattro	without ball bearing	E	'E 'H	MO6180
TT Roadster (8N9)				10/1999 → 06/2006	
Control Arm-/Trailing Arm Bush	1.8 T, 1.8 T quattro		E	'E 'H	BS6417
Control Arm-/Trailing Arm Bush	1.8 T, 1.8 T quattro	ch.→8N-Y-060000	E	'E 'H	BS6911
Top Strut Mounting	1.8 T, 1.8 T quattro, 3.2 VR6 quattro	without ball bearing	E	'E 'H	MO6180
TT (8J3)				08/2006 → 06/2014	
Control Arm-/Trailing Arm Bush	1.8 TFSI, 2.0 quattro, 2.0 TDI quattro, 2.0 TFSI, 2.0 TFSI quattro, 2.5 TFSI quattro, 3.2 V6 quattro	Rubber-metal Bearing	E	'E 'H	BS6899
Rod/Strut, stabiliser	1.8 TFSI, 2.0 quattro, 2.0 TDI quattro, 2.0 TFSI, 2.0 TFSI quattro, 2.5 TFSI quattro, 3.2 V6 quattro	Material: Steel	E	'E 'H	CTR5849
TT Roadster (8J9)				03/2007 → 06/2014	
Control Arm-/Trailing Arm Bush	1.8 TFSI, 2.0 quattro, 2.0 TDI quattro, 2.0 TFSI, 2.0 TFSI quattro, 2.5 TFSI quattro, 3.2 V6 quattro	Rubber-metal Bearing	E	'E 'H	BS6899
Rod/Strut, stabiliser	1.8 TFSI, 2.0 quattro, 2.0 TDI quattro, 2.0 TFSI, 2.0 TFSI quattro, 2.5 TFSI quattro, 3.2 V6 quattro	Material: Steel	E	'E 'H	CTR5849

AUDI

						
BS6417	BS6899	BS6911	CJ293	CTR5491	CTR5849	MO6180
Ref.Nr.: 1J0407181	Ref.Nr.: 1K0407182	Ref.Nr.: 191407182	Ref.Nr.: 4D0407694K	Ref.Nr.: 4B0419811B	Ref.Nr.: 1K0411315G	Ref.Nr.: 1J0412331B
						
RE5841						
Ref.Nr.: 1K0423810A						

Article Description			Fitting Position	Article No.
---------------------	---	---	------------------	-------------

1 (E81)

09/2006 → 09/2012

Track Control Arm	116 d, 116 i, 118 d, 118 i, 120 d, 120 i, 123 d, 130 i		E	'E		CJ1149
Track Control Arm	116 d, 116 i, 118 d, 118 i, 120 d, 120 i, 123 d, 130 i		E		'H	CJ1150
Rod/Strut, stabiliser	116 d, 116 i, 118 d, 118 i, 120 d, 120 i, 123 d, 130 i	Material: Steel	E	'E		CTR5875L
Rod/Strut, stabiliser	116 d, 116 i, 118 d, 118 i, 120 d, 120 i, 123 d, 130 i	Material: Steel	E		'H	CTR5875R
Tie Rod Axle Joint	116 d, 116 i, 116d, 118 d, 120 d, 123 d	for steering gear manufacturer: TRW	E	'E	'H	RE5843
Tie Rod Axle Joint	118 i, 120 i	Engine Code: N46N; for steering gear manufacturer: TRW	E	'E	'H	RE5843

1 Coupe (E82)

10/2007 → 10/2013

Track Control Arm	118 d, 120 d, 120 i, 123 d, 125 i, 135 i		E	'E		CJ1149
Track Control Arm	118 d, 120 d, 120 i, 123 d, 125 i, 135 i		E		'H	CJ1150
Rod/Strut, stabiliser	118 d, 120 d, 120 i, 123 d, 125 i, 135 i	Material: Steel	E	'E		CTR5875L
Rod/Strut, stabiliser	118 d, 120 d, 120 i, 123 d, 125 i, 135 i	Material: Steel	E		'H	CTR5875R
Tie Rod Axle Joint	118 d, 120 d, 123 d	for steering gear manufacturer: TRW	E	'E	'H	RE5843
Tie Rod Axle Joint	120 i	Engine Code: N46N; for steering gear manufacturer: TRW	E	'E	'H	RE5843

1 (E87)

11/2003 → 01/2013

Track Control Arm	116 d, 116 i, 118 d, 118 i, 120 d, 120 i, 123 d, 130 i		E	'E		CJ1149
Track Control Arm	116 d, 116 i, 118 d, 118 i, 120 d, 120 i, 123 d, 130 i		E		'H	CJ1150
Rod/Strut, stabiliser	116 d, 116 i, 118 d, 118 i, 120 d, 120 i, 123 d, 130 i	Material: Steel	E	'E		CTR5875L
Rod/Strut, stabiliser	116 d, 116 i, 118 d, 118 i, 120 d, 120 i, 123 d, 130 i	Material: Steel	E		'H	CTR5875R
Tie Rod Axle Joint	116 d, 116 i, 116d, 118 d, 118 i, 120 d, 120 i, 123 d	for steering gear manufacturer: TRW	E	'E	'H	RE5843

1 Convertible (E88)

03/2008 → 12/2013

Track Control Arm	118 d, 118 i, 120 d, 120 i, 123 d, 125 i, 135 i		E	'E		CJ1149
Track Control Arm	118 d, 118 i, 120 d, 120 i, 123 d, 125 i, 135 i		E		'H	CJ1150
Rod/Strut, stabiliser	118 d, 118 i, 120 d, 120 i, 123 d, 125 i, 135 i	Material: Steel	E	'E		CTR5875L
Rod/Strut, stabiliser	118 d, 118 i, 120 d, 120 i, 123 d, 125 i, 135 i	Material: Steel	E		'H	CTR5875R
Tie Rod Axle Joint	118 d, 118 i, 120 d, 120 i, 123 d	for steering gear manufacturer: TRW	E	'E	'H	RE5843

3 (E30)











09/1982 → 01/1992

Control Arm-/Trailing Arm Bush	320 i, 320 is, 323 i	Automatic Transmission; for vehicles with air conditioning	E	'E	'H	BS5422
Control Arm-/Trailing Arm Bush	324 d, 324 td, 325 e 2.7, 325 i		E	'E	'H	BS5422
Ball Joint	316, 316i, 318i, 318is, 320i, 323i, 324 d, 324td, 325 e 2.7, 325 i, 325 i X, M3 2.3		E	'E	'H	CJ847
Ball Joint	316, 316i, 318i, 318is, 320i, 323i, 324 d, 324td, 325 e 2.7, 325 i, 325 i X, M3 2.3		E	'E	'H	CJ848
Rod/Strut, stabiliser	316, 316i, 318i, 318is, 320i, 323i, 324 d, 324td, 325 e 2.7, 325 i		E	'E	'H	CTR5159
Rod/Strut, stabiliser	M3 2.3, M3 EVO I 2.3, M3 EVO II 2.5		E	'E	'H	CTR5380
Tie Rod Axle Joint	315, 316, 316i, 318i, 318is, 320i, 323i, 324 d, 324td, 325 e 2.7, 325 i, M3 2.3, M3 EVO I 2.3, M3 EVO II 2.5	for OE: 32111127124	E	'E	'H	RE5472

3 Convertible (E30)

12/1985 → 10/1993

Control Arm-/Trailing Arm Bush	318 i, 320 i, 325 i		E	'E	'H	BS5422
--------------------------------	---------------------	--	---	----	----	--------

						
BS5422	CJ1149	CJ1150	CJ847	CJ848	CTR5159	CTR5380
Ref.Nr.: 31121130123	Ref.Nr.: 31122405861	Ref.Nr.: 31126769802	Ref.Nr.: 31121126254	Ref.Nr.: 31121139131	Ref.Nr.: 31351127689	Ref.Nr.: 31351124380
						
CTR5875L	CTR5875R	RE5472	RE5843			
Ref.Nr.: 31356765933	Ref.Nr.: 31356765934	Ref.Nr.: 32111127124	Ref.Nr.: 32216762244			

Article Description			Fitting Position	Article No.
---------------------	---	---	------------------	-------------

3 Convertible (E30)

12/1985 → 10/1993

Ball Joint	318 i, 320 i, 325 i, M3 2.3		E	'E 'H	CJ847
Ball Joint	318 i, 320 i, 325 i, M3 2.3		E	'E 'H	CJ848
Rod/Strut, stabiliser	318 i, 320 i, 325 i		E	'E 'H	CTR5159
Tie Rod Axle Joint	318 i, 320 i, 325 i, M3 2.3	for OE: 32111127124	E	'E 'H	RE5472

3 Touring (E30)

07/1987 → 06/1994

Control Arm-/Trailing Arm Bush	320 i	Automatic Transmission; for vehicles with air conditioning	E	'E 'H	BS5422
Control Arm-/Trailing Arm Bush	324 td, 325 i		E	'E 'H	BS5422
Ball Joint	316 i, 318 i, 320 i, 324 td, 325 i, 325 i X		E	'E 'H	CJ847
Ball Joint	316 i, 318 i, 320 i, 324 td, 325 i, 325 i X		E	'E 'H	CJ848
Rod/Strut, stabiliser	316 i, 318 i, 320 i, 324 td, 325 i		E	'E 'H	CTR5159
Tie Rod Axle Joint	316 i, 318 i, 320 i, 324 td, 325 i	for OE: 32111127124	E	'E 'H	RE5472

3 (E36)

09/1990 → 02/1998

Control Arm-/Trailing Arm Bush	316 i, 318 i, 318 is, 318 tds, 320 i, 323 i 2.5, 325 i, 325 td, 325 tds		E	'E 'H	BS5421
Ball Joint	316 i, 318 i, 318 is, 318 tds, 320 i, 323 i 2.5, 325 i, 325 td, 325 tds, 328 i, M3 3.0, M3 3.2	without holder	E	'E 'H	CJ863
Track Control Arm	316 i, 318 i, 318 is, 318 tds, 320 i, 323 i 2.5, 325 i, 325 td, 325 tds	Material: Steel; with ball joint, without rubber mounting; without holder	E	'E	CJ870L
Track Control Arm	316 i, 318 i, 318 is, 318 tds, 320 i, 323 i 2.5, 325 i, 325 td, 325 tds	Material: Steel; with ball joint, without rubber mounting; without holder	E	'H	CJ870R
Rod/Strut, stabiliser	316 i, 318 i, 318 is, 318 tds, 320 i, 323 i 2.5, 325 i, 325 td, 325 tds, 328 i	10/1991 →	E	'E 'H	CTR5159
Rod/Strut, stabiliser	316 i, 318 i, 320 i, 325 i, 325 td	→ 10/1991	E	'E 'H	CTR5380
Tie Rod Axle Joint	316 i, 318 i, 318 is, 318 tds, 320 i, 323 i 2.5, 325 i, 325 td, 325 tds, M3 3.2		E	'E 'H	RE046
Tie Rod Axle Joint	316 i [M40 B16]	for vehicles without power steering	E	'H	RE5489
Tie Rod Axle Joint	316 i [M43 B16]	with steering damper	E	'H	RE5489

3 Convertible (E36)













03/1993 → 04/1999

Control Arm-/Trailing Arm Bush	318 i, 320 i, 323 i, 325 i, 328 i		E	'E 'H	BS5421
Ball Joint	318 i, 320 i, 323 i, 325 i, 328 i, M3 3.0, M3 3.2	without holder	E	'E 'H	CJ863
Track Control Arm	318 i, 320 i, 323 i, 325 i, 328 i	Material: Steel; with ball joint, without rubber mounting; without holder	E	'E	CJ870L
Track Control Arm	318 i, 320 i, 323 i, 325 i, 328 i	Material: Steel; with ball joint, without rubber mounting; without holder	E	'H	CJ870R
Rod/Strut, stabiliser	318 i, 320 i, 323 i, 325 i, 328 i		E	'E 'H	CTR5159
Tie Rod Axle Joint	318 i, 320 i, 323 i, 325 i, 328 i, M3 3.0		E	'E 'H	RE046

3 Compact (E36)

03/1994 → 08/2000

Control Arm-/Trailing Arm Bush	316 i, 318 tds, 318 ti		E	'E 'H	BS5421
Ball Joint	316 i		E	'E 'H	CJ848
Ball Joint	316 g, 316 i, 318 tds, 318 ti, 323 ti	without holder	E	'E 'H	CJ863
Track Control Arm	316 i, 318 tds, 318 ti	Material: Steel; with ball joint, without rubber mounting; without holder	E	'E	CJ870L
Track Control Arm	316 i, 318 tds, 318 ti	Material: Steel; with ball joint, without rubber mounting; without holder	E	'H	CJ870R

						
BS5421	BS5422	CJ847	CJ848	CJ863	CJ870L	CJ870R
Ref.Nr.: 31129059288	Ref.Nr.: 31121130123	Ref.Nr.: 31121126254	Ref.Nr.: 31121139131	Ref.Nr.: 31121140398	Ref.Nr.: 31121094275	Ref.Nr.: 31121136530
						
CTR5159	CTR5380	RE046	RE5472	RE5489		
Ref.Nr.: 31351127689	Ref.Nr.: 31351124380	Ref.Nr.: 32111139315PA	Ref.Nr.: 32111127124	Ref.Nr.: 32111139318PA		

Article Description			Fitting Position	Article No.
---------------------	---	---	------------------	-------------

3 Compact (E36)

03/1994 → 08/2000

Rod/Strut, stabiliser	316 g, 316 i, 318 tds, 318 ti, 323 ti		E	'E	'H	CTR5159
Tie Rod Axle Joint	316 i, 318 tds, 318 ti		E	'E	'H	RE046

3 Coupe (E36)

03/1992 → 04/1999

Control Arm-/Trailing Arm Bush	316 i, 318 is, 320 i, 323 i, 325 i, 328 i		E	'E	'H	BS5421
Ball Joint	316 i, 318 is, 320 i, 323 i, 325 i, 328 i, M3 3.0, M3 3.2	without holder	E	'E	'H	CJ863
Track Control Arm	316 i, 318 is, 320 i, 323 i, 325 i, 328 i	Material: Steel; with ball joint, without rubber mounting; without holder	E	'E		CJ870L
Track Control Arm	316 i, 318 is, 320 i, 323 i, 325 i, 328 i	Material: Steel; with ball joint, without rubber mounting; without holder	E		'H	CJ870R
Rod/Strut, stabiliser	316 i, 318 is, 320 i, 323 i, 325 i, 328 i		E	'E	'H	CTR5159
Tie Rod Axle Joint	316 i, 318 is, 320 i, 323 i, 325 i, 328 i, M3 3.0, M3 3.2		E	'E	'H	RE046

3 Touring (E36)

01/1995 → 10/1999

Control Arm-/Trailing Arm Bush	318 i, 318 tds, 320 i, 323 i, 325 tds, 328 i		E	'E	'H	BS5421
Ball Joint	316 i, 318 i, 318 tds, 320 i, 323 i, 325 tds, 328 i	without holder	E	'E	'H	CJ863
Track Control Arm	318 i, 318 tds, 320 i, 323 i, 325 tds, 328 i	Material: Steel; with ball joint, without rubber mounting; without holder	E	'E		CJ870L
Track Control Arm	318 i, 318 tds, 320 i, 323 i, 325 tds, 328 i	Material: Steel; with ball joint, without rubber mounting; without holder	E		'H	CJ870R
Rod/Strut, stabiliser	316 i, 318 i, 318 tds, 320 i, 323 i, 325 tds, 328 i		E	'E	'H	CTR5159
Tie Rod Axle Joint	318 i, 318 tds, 320 i, 323 i, 325 tds, 328 i		E	'E	'H	RE046

3 (E46)













02/1998 → 04/2005

Holder, control arm mounting	316i, 318d, 318i, 320d, 320i, 323i, 325i, 328i, 330d, 330i	Hydro Bearing; Material: Aluminium	E	'E		BS7204
Holder, control arm mounting	316i, 318d, 318i, 320d, 320i, 323i, 325i, 328i, 330d, 330i	Hydro Bearing; Material: Aluminium	E		'H	BS7205
Track Control Arm	316i, 318d, 318i, 320d, 320i, 323i, 325i, 328i, 330d, 330i	Material: Aluminium; not for equipment variant: M Sport II, S338A; with ball joint, with fastening material, without rubber mounting; without holder; for vehicles without sports package	E		'H	CJ142
Track Control Arm	316i, 318d, 318i, 320d, 320i, 323i, 325i, 328i, 330d, 330i	Material: Aluminium; not for equipment variant: M Sport II, S338A; with ball joint, with fastening material, without rubber mounting; without holder; for vehicles without sports package	E	'E		CJ143
Rod/Strut, stabiliser	316i, 318d, 318i, 320d, 320i, 323i, 325i, 328i, 330d, 330i	Material: Steel	E	'E	'H	CTR5605
Tie Rod Axle Joint	316i, 318d, 318i, 320d, 320i, 323i, 325i, 325xi, 328i, 330d, 330i, 330xd, 330xi		E	'E	'H	RE5604

3 Convertible (E46)

04/2000 → 12/2007

Holder, control arm mounting	318 Ci, 320 Cd, 320 Ci, 323 Ci, 325 Ci, 330 Cd, 330 Ci	Hydro Bearing; Material: Aluminium	E	'E		BS7204
Holder, control arm mounting	318 Ci, 320 Cd, 320 Ci, 323 Ci, 325 Ci, 330 Cd, 330 Ci	Hydro Bearing; Material: Aluminium	E		'H	BS7205
Track Control Arm	318 Ci, 320 Cd, 320 Ci, 323 Ci, 325 Ci, 330 Cd, 330 Ci	Material: Aluminium; not for equipment variant: M Sport II, S338A; with ball joint, with fastening material, without rubber mounting; without holder; for vehicles without sports package	E		'H	CJ142
Track Control Arm	318 Ci, 320 Cd, 320 Ci, 325 Ci, 330 Cd, 330 Ci	Material: Aluminium; not for equipment variant: M Sport II, S338A; with ball joint, with fastening material, without rubber mounting; without holder; for vehicles without sports package	E	'E		CJ143
Track Control Arm	323 Ci	Material: Aluminium; with ball joint, with fastening material, without rubber mounting; without holder	E	'E		CJ143

						
BS5421	BS7204	BS7205	CJ142	CJ143	CJ863	CJ870L
Ref.Nr.: 31129059288	Ref.Nr.: 31124004359	Ref.Nr.: 31126754899	Ref.Nr.: 31126777852	Ref.Nr.: 31126752717	Ref.Nr.: 31121140398	Ref.Nr.: 31121094275
						
CJ870R	CTR5159	CTR5605	RE046	RE5604		
Ref.Nr.: 31121136530	Ref.Nr.: 31351127689	Ref.Nr.: 6Q0411315E	Ref.Nr.: 32111139315PA	Ref.Nr.: 32111096897PA		

Article Description			Fitting Position	Article No.
---------------------	---	---	------------------	-------------

3 Convertible (E46)

04/2000 → 12/2007

Rod/Strut, stabiliser	318 Ci, 320Cd, 320 Ci, 323 Ci, 325 Ci, 330 Cd, 330 Ci, M3 3.2	Material: Steel	E	'E	'H	CTR5605
Tie Rod Axle Joint	318 Ci, 320 Ci, 323 Ci, 325 Ci, 330 Ci, M3 3.2		E	'E	'H	RE5604

3 Compact (E46)

06/2001 → 02/2005

Holder, control arm mounting	316 ti, 318 td, 318 ti, 320 td, 325 ti	Hydro Bearing; Material: Aluminium	E	'E		BS7204
Holder, control arm mounting	316 ti, 318 td, 318 ti, 320 td, 325 ti	Hydro Bearing; Material: Aluminium	E		'H	BS7205
Track Control Arm	316 ti, 318 td, 318 ti, 320 td, 325 ti	Material: Aluminium; not for equipment variant: M Sport II, S338A; with ball joint, with fastening material, without rubber mounting; without holder; for vehicles without sports package	E		'H	CJ142
Track Control Arm	316 ti, 318 td, 318 ti, 320 td, 325 ti	Material: Aluminium; not for equipment variant: M Sport II, S338A; with ball joint, with fastening material, without rubber mounting; without holder; for vehicles without sports package	E	'E		CJ143
Rod/Strut, stabiliser	316 ti, 318 td, 318 ti, 320 td, 325 ti	Material: Steel	E	'E	'H	CTR5605
Tie Rod Axle Joint	316 ti, 318 ti, 320 td, 325 ti		E	'E	'H	RE5604

3 Coupe (E46)

04/1999 → 07/2006

Holder, control arm mounting	316 Ci, 318 Ci, 320 Cd, 320 Ci, 323 Ci, 325 Ci, 328 Ci, 330 Cd	Hydro Bearing; Material: Aluminium	E	'E		BS7204
Holder, control arm mounting	316 Ci, 318 Ci, 320 Cd, 320 Ci, 323 Ci, 325 Ci, 328 Ci, 330 Cd	Hydro Bearing; Material: Aluminium	E		'H	BS7205
Track Control Arm	316 Ci, 318 Ci, 320 Cd, 320 Ci, 323 Ci, 325 Ci, 328 Ci, 330 Cd, 330 Ci	Material: Aluminium; not for equipment variant: M Sport II, S338A; with ball joint, with fastening material, without rubber mounting; without holder; for vehicles without sports package	E		'H	CJ142
Track Control Arm	316 Ci, 318 Ci, 320 Cd, 320 Ci, 323 Ci, 325 Ci, 328 Ci, 330 Cd, 330 Ci	Material: Aluminium; not for equipment variant: M Sport II, S338A; with ball joint, with fastening material, without rubber mounting; without holder; for vehicles without sports package	E	'E		CJ143
Rod/Strut, stabiliser	316 Ci, 318 Ci, 320 Cd, 320 Ci, 323 Ci, 325 Ci, 328 Ci, 330 Cd, 330 Ci, M3 3.2, M3 CSL	Material: Steel	E	'E	'H	CTR5605
Tie Rod Axle Joint	316 Ci, 318 Ci, 320 Ci, 323 Ci, 325 Ci, 328 Ci, 330 xi, M3 3.2		E	'E	'H	RE5604

3 Touring (E46)









10/1999 → 02/2005



Holder, control arm mounting	316 i, 318 d, 318 i, 320 d, 320 i, 325 i, 328 i, 330 d, 330 i	Hydro Bearing; Material: Aluminium	E	'E		BS7204
Holder, control arm mounting	316 i, 318 d, 318 i, 320 d, 320 i, 325 i, 328 i, 330 d, 330 i	Hydro Bearing; Material: Aluminium	E		'H	BS7205
Track Control Arm	316 i, 318 d, 318 i, 320 d, 320 i, 325 i, 328 i, 330 d, 330 i	Material: Aluminium; not for equipment variant: M Sport II, S338A; with ball joint, with fastening material, without rubber mounting; without holder; for vehicles without sports package	E		'H	CJ142
Track Control Arm	316 i, 318 d, 318 i, 320 d, 320 i, 325 i, 328 i, 330 d, 330 i	Material: Aluminium; not for equipment variant: M Sport II, S338A; with ball joint, with fastening material, without rubber mounting; without holder; for vehicles without sports package	E	'E		CJ143
Rod/Strut, stabiliser	316 i, 318 d, 318 i, 320 d, 320 i, 325 i, 328 i, 330 d, 330 i	Material: Steel	E	'E	'H	CTR5605
Tie Rod Axle Joint	318 i, 320 d, 320 i, 325 i, 328 i, 330 d, 330 i		E	'E	'H	RE5604







3 (E90)



01/2005 → 12/2011











Track Control Arm	316d, 316i, 318d, 318i, 320d, 320i, 320si, 323i, 325d, 325i, 328i, 330d, 330i, 335d, 335i		E	'E		CJ1149
Track Control Arm	316d, 316i, 318d, 318i, 320d, 320i, 320si, 323i, 325d, 325i, 328i, 330d, 330i, 335d, 335i		E		'H	CJ1150
Rod/Strut, stabiliser	316d, 316i, 318d, 318i, 320d, 320i, 320si, 323i, 325d, 325i, 328i, 330d, 330i, 335d, 335i	Material: Steel	E	'E		CTR5875L



						
BS7204	BS7205	CJ1149	CJ1150	CJ142	CJ143	CTR5605
Ref.Nr.: 31124004359	Ref.Nr.: 31126754899	Ref.Nr.: 31122405861	Ref.Nr.: 31126769802	Ref.Nr.: 31126777852	Ref.Nr.: 31126752717	Ref.Nr.: 6Q0411315E
						
CTR5875L	RE5604					
Ref.Nr.: 31356765933	Ref.Nr.: 32111096897PA					















Article Description						Fitting Position	Article No.
3 (E90)							01/2005 → 12/2011
Rod/Strut, stabiliser	316 d, 316 i, 318 d, 318 i, 320 d, 320 i, 320 si, 323 i, 325 d, 325 i, 328 i, 330 d, 330 i, 335 d, 335 i	Material: Steel		E		'H	CTR5875R
Tie Rod Axle Joint	316 d, 316 i, 318 d, 318 i, 320 si	for steering gear manufacturer: TRW		E		'E 'H	RE5843
Tie Rod Axle Joint	318 i, 320 i	Engine Code: N46, N46N; for steering gear manufacturer: TRW		E		'E 'H	RE5843
Tie Rod Axle Joint	320 d	Engine Code: N47, N47N; for steering gear manufacturer: TRW		E		'E 'H	RE5843
3 Convertible (E93)							03/2007 → 12/2013
Track Control Arm	320 d, 320 i, 323 i, 325 d, 325 i, 330 d, 330 i, 335 i			E		'E	CJ1149
Track Control Arm	320 d, 320 i, 323 i, 325 d, 325 i, 330 d, 330 i, 335 i			E		'H	CJ1150
Rod/Strut, stabiliser	320 d, 320 i, 323 i, 325 d, 325 i, 330 d, 330 i, 335 i	Material: Steel		E		'E	CTR5875L
Rod/Strut, stabiliser	320 d, 320 i, 323 i, 325 d, 325 i, 330 d, 330 i, 335 i	Material: Steel		E		'H	CTR5875R
Tie Rod Axle Joint	320 d	for steering gear manufacturer: TRW		E		'E 'H	RE5843
Tie Rod Axle Joint	320 i	Engine Code: N46N; for steering gear manufacturer: TRW		E		'E 'H	RE5843
3 Coupe (E92)							06/2006 → 12/2013
Track Control Arm	320 d, 320 i, 323 i, 325 d, 325 i, 328 i, 330 d, 330 i, 335 d, 335 i			E		'E	CJ1149
Track Control Arm	320 d, 320 i, 323 i, 325 d, 325 i, 328 i, 330 d, 330 i, 335 d, 335 i			E		'H	CJ1150
Rod/Strut, stabiliser	320 d, 320 i, 323 i, 325 d, 325 i, 328 i, 330 d, 330 i, 335 d, 335 i	Material: Steel		E		'E	CTR5875L
Rod/Strut, stabiliser	320 d, 320 i, 323 i, 325 d, 325 i, 328 i, 330 d, 330 i, 335 d, 335 i	Material: Steel		E		'H	CTR5875R
Tie Rod Axle Joint	320 d	for steering gear manufacturer: TRW		E		'E 'H	RE5843
Tie Rod Axle Joint	320 i	Engine Code: N46N; for steering gear manufacturer: TRW		E		'E 'H	RE5843
3 Touring (E91)							12/2004 → 06/2012
Track Control Arm	316 i, 318 d, 318 i, 320 d, 320 i, 323 i, 325 d, 325 i, 330 d, 330 i, 335 d, 335 i			E		'E	CJ1149
Track Control Arm	316 i, 318 d, 318 i, 320 d, 320 i, 323 i, 325 d, 325 i, 330 d, 330 i, 335 d, 335 i			E		'H	CJ1150
Rod/Strut, stabiliser	316 i, 318 d, 318 i, 320 d, 320 i, 323 i, 325 d, 325 i, 330 d, 330 i, 335 d, 335 i	Material: Steel		E		'E	CTR5875L
Rod/Strut, stabiliser	316 i, 318 d, 318 i, 320 d, 320 i, 323 i, 325 d, 325 i, 330 d, 330 i, 335 d, 335 i	Material: Steel		E		'H	CTR5875R
Tie Rod Axle Joint	316 d, 320 d, 320 i	for steering gear manufacturer: TRW		E		'E 'H	RE5843
Tie Rod Axle Joint	318 i	Engine Code: N46, N46N; for steering gear manufacturer: TRW		E		'E 'H	RE5843
Tie Rod Axle Joint	320 d	Engine Code: N47, N47N; for steering gear manufacturer: TRW		E		'E 'H	RE5843
5 (E28)							06/1981 → 12/1987
Rod/Strut, stabiliser	518, 518 i, 520 i, 524 d, 524 td, 525 e, 525 i, 528 i, 535 i, M 535 i, M 3.5			E		'E 'H	CTR5380
5 (E34)							01/1988 → 09/1995
Control Arm-/Trailing Arm Bush	518 i	Rubber-metal Bearing; for OE: 31121132159, 31121132160, 31121133711, 31121133712, 31121141097, 31121141098		E		'E 'H	BS6177

						
BS6177	CJ1149	CJ1150	CTR5380	CTR5875L	CTR5875R	RE5843
Ref.Nr.: 31121133710	Ref.Nr.: 31122405861	Ref.Nr.: 31126769802	Ref.Nr.: 31351124380	Ref.Nr.: 31356765933	Ref.Nr.: 31356765934	Ref.Nr.: 32216762244

Article Description			Fitting Position	Article No.
5 (E34) 01/1988 → 09/1995				
Rod/Strut, stabiliser	518 i, 520 i, 520 i 24V, 524 td, 525 i, 525 i 24V, 525 i X 24V, 525 td, 525 tds, 530 i, 530 i V8, 535 i, 540 i V8, M 3.6 CAT, M 3.8		E 'E 'H	CTR5380
5 Touring (E34) 11/1991 → 01/1997				
Control Arm-/Trailing Arm Bush	518 g, 518 i	Rubber-metal Bearing; for OE: 31121132159, 31121132160, 31121133711, 31121133712, 31121141097, 31121141098	E 'E 'H	BS6177
Rod/Strut, stabiliser	518 g, 518 i, 520 i, 525 i, 525 ix, 525 td, 525 tds, 530 i V8, 540 i, M 3.8		E 'E 'H	CTR5380
5 (E39) 11/1995 → 06/2003				
Track Control Arm	520 d, 520 i, 523 i, 525 d, 525 i, 525 td, 525 tds, 528 i, 530 d, 530 i	Material: Aluminium; with rubber mounting	E 'E	CJ1065L
Track Control Arm	520 d, 520 i, 523 i, 525 d, 525 i, 525 td, 525 tds, 528 i, 530 d, 530 i	Material: Aluminium; with rubber mounting	E 'H	CJ1065R
Track Control Arm	520 d, 520 i, 523 i, 525 d, 525 i, 525 td, 525 tds, 528 i, 530 d, 530 i	Material: Aluminium	E 'E	CJ1066L
Track Control Arm	520 d, 520 i, 523 i, 525 d, 525 i, 525 td, 525 tds, 528 i, 530 d, 530 i	Material: Aluminium	E 'H	CJ1066R
Tie Rod Axle Joint	520 d, 520 i, 523 i, 525 d, 525 i, 525 td, 525 tds, 528 i, 530 d, 530 i		E 'E 'H	RE5549
5 Touring (E39) 01/1997 → 05/2004				
Track Control Arm	520 d, 520 i, 523 i, 525 d, 525 i, 525 tds, 528 i, 530 d, 530 i	Material: Aluminium; with rubber mounting	E 'E	CJ1065L
Track Control Arm	520 d, 520 i, 523 i, 525 d, 525 i, 525 tds, 528 i, 530 d, 530 i	Material: Aluminium; with rubber mounting	E 'H	CJ1065R
Track Control Arm	520 d, 520 i, 523 i, 525 d, 525 i, 525 tds, 528 i, 530 d, 530 i	Material: Aluminium	E 'E	CJ1066L
Track Control Arm	520 d, 520 i, 523 i, 525 d, 525 i, 525 tds, 528 i, 530 d, 530 i	Material: Aluminium	E 'H	CJ1066R
Tie Rod Axle Joint	520 d, 520 i, 523 i, 525 d, 525 i, 525 tds, 528 i, 530 d, 530 i		E 'E 'H	RE5549
5 (E60) 07/2003 → 03/2010				
Track Control Arm	520 d, 520 i, 520 i, 523 i, 525 d, 525 i, 530 d, 530 i, 535 d, 540 i, 545 i, 550 i, M	Rubber-metal Bearing; Material: Aluminium; with ball joint, with rubber mounting	E 'H	CJ1151
Track Control Arm	520 d, 520 i, 520 i, 523 i, 525 d, 525 i, 530 d, 530 i, 535 d, 540 i, 545 i, 550 i, M	Rubber-metal Bearing; Material: Aluminium; with ball joint, with rubber mounting	E 'E	CJ1152
Tie Rod Axle Joint	520 d, 520 i, 523 i, 525 d, 525 i, 525 xi, 530 d, 530 i, 530 xd, 530 xi, 535 d, 540 i, 545 i, 550 i, M		E 'E 'H	RE5845
5 Touring (E61) 06/2004 → 12/2010				
Track Control Arm	520 d, 520 i, 520 i, 523 i, 525 d, 525 i, 530 d, 530 i, 535 d, 545 i, 550 i, M	Rubber-metal Bearing; Material: Aluminium; with ball joint, with rubber mounting	E 'H	CJ1151
Track Control Arm	520 d, 520 i, 520 i, 523 i, 525 d, 525 i, 530 d, 530 i, 535 d, 545 i, 550 i, M	Rubber-metal Bearing; Material: Aluminium; with ball joint, with rubber mounting	E 'E	CJ1152
Tie Rod Axle Joint	525 d, 525 i, 530 d, 530 i, 535 d, 545 i		E 'E 'H	RE5845
6 (E24) 06/1978 → 05/1989				
Rod/Strut, stabiliser	628 CSi, 635 CSi, M 635 CSi	05/1982 →	E 'E 'H	CTR5380
7 (E32) 09/1986 → 09/1994				
Rod/Strut, stabiliser	730 i, iL, 730 i, iL V8, 735 i, iL, 740 i, iL V8, 750 i, iL V12		E 'E 'H	CTR5380

						
BS6177	CJ1065L	CJ1065R	CJ1066L	CJ1066R	CJ1151	CJ1152
Ref.Nr.: 31121133710	Ref.Nr.: 31121141717	Ref.Nr.: 31121141718	Ref.Nr.: 31121093449	Ref.Nr.: 31121093450	Ref.Nr.: 31122347952	Ref.Nr.: 31122347951
						
CTR5380	RE5549	RE5845				
Ref.Nr.: 31351124380	Ref.Nr.: 32111091768*	Ref.Nr.: 32106774347PA				

Article Description			Fitting Position	Article No.
8 (E31)				04/1990 → 12/1999
Rod/Strut, stabiliser	840 Ci, 840 i, 850 Ci, 850 CSi, 850 i,Ci		E 'E 'H	CTR5380
X1 (E84)				03/2009 → 06/2015
Track Control Arm	sDrive 18 d, sDrive 18 i, sDrive 20 d, sDrive 20 i		E 'E	CJ1149
Track Control Arm	sDrive 18 d, sDrive 18 i, sDrive 20 d, sDrive 20 i		E 'H	CJ1150
Rod/Strut, stabiliser	sDrive 18 d, sDrive 18 i, sDrive 20 d, sDrive 20 i	Material: Steel	E 'E	CTR5875L
Rod/Strut, stabiliser	sDrive 18 d, sDrive 18 i, sDrive 20 d, sDrive 20 i	Material: Steel	E 'H	CTR5875R
Tie Rod Axle Joint	sDrive 18 d, sDrive 18 i, sDrive 20 d	for steering gear manufacturer: TRW	E 'E 'H	RE5843
Z1				06/1988 → 06/1991
Control Arm-/Trailing Arm Bush	2.5		E 'E 'H	BS5422
Ball Joint	2.5		E 'E 'H	CJ848
Rod/Strut, stabiliser	2.5		E 'E 'H	CTR5159
Z3 (E36)				10/1995 → 01/2003
Control Arm-/Trailing Arm Bush	1.8, 1.9, 2.0, 2.8		E 'E 'H	BS5421
Ball Joint	1.8, 1.9, 2.0, 2.2, 2.8, 3.0, M 3.2	without holder	E 'E 'H	CJ863
Track Control Arm	1.8, 1.9, 2.0	Material: Steel; with ball joint, without rubber mounting; without holder	E 'E	CJ870L
Track Control Arm	1.8, 1.9, 2.0	Material: Steel; with ball joint, without rubber mounting; without holder	E 'H	CJ870R
Rod/Strut, stabiliser	1.8, 1.9, 2.0, 2.2, 2.8, 3.0		E 'E 'H	CTR5159
Tie Rod Axle Joint	1.8, 1.9, 2.0, 2.8, M 3.2		E 'E 'H	RE046

						
BS5421	BS5422	CJ1149	CJ1150	CJ848	CJ863	CJ870L
Ref.Nr.: 31129059288	Ref.Nr.: 31121130123	Ref.Nr.: 31122405861	Ref.Nr.: 31126769802	Ref.Nr.: 31121139131	Ref.Nr.: 31121140398	Ref.Nr.: 31121094275
						
CJ870R	CTR5159	CTR5380	CTR5875L	CTR5875R	RE046	RE5843
Ref.Nr.: 31121136530	Ref.Nr.: 31351127689	Ref.Nr.: 31351124380	Ref.Nr.: 31356765933	Ref.Nr.: 31356765934	Ref.Nr.: 32111139315PA	Ref.Nr.: 32216762244

Article Description			Fitting Position	Article No.
---------------------	---	---	------------------	-------------

Z3 Coupe (E36)







07/1997 → 06/2003

Control Arm-/Trailing Arm Bush	2.8		E	'E 'H	BS5421
Ball Joint	2.8, 3.0, M	without holder	E	'E 'H	CJ863
Track Control Arm	2.8	Material: Steel; with ball joint, without rubber mounting; without holder	E	'E	CJ870L
Track Control Arm	2.8	Material: Steel; with ball joint, without rubber mounting; without holder	E	'H	CJ870R
Rod/Strut, stabiliser	2.8, 3.0		E	'E 'H	CTR5159
Tie Rod Axle Joint	2.8, M		E	'E 'H	RE046

Z4 (E85)

02/2003 → 02/2009

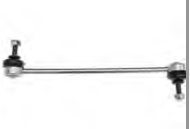
Holder, control arm mounting	2.0 i, 2.2 i, 2.5 i, 2.5 si, 3.0 i, 3.0 si, M	Hydro Bearing; Material: Aluminium	E	'E	BS7204
Holder, control arm mounting	2.0 i, 2.2 i, 2.5 i, 2.5 si, 3.0 i, 3.0 si, M	Hydro Bearing; Material: Aluminium	E	'H	BS7205
Track Control Arm	2.0 i, 2.2 i, 2.5 i, 2.5 si, 3.0 i, 3.0 si	Material: Aluminium; with ball joint, with fastening material, without rubber mounting; without holder	E	'H	CJ142
Track Control Arm	2.0 i, 2.2 i, 2.5 i, 2.5 si, 3.0 i, 3.0 si	Material: Aluminium; with ball joint, with fastening material, without rubber mounting; without holder	E	'E	CJ143
Rod/Strut, stabiliser	2.0 i, 2.2 i, 2.5 i, 2.5 si, 3.0 i, 3.0 si, M	Material: Steel	E	'E 'H	CTR5605
Tie Rod Axle Joint	2.0 i, 2.2 i, 2.5 i, 3.0 i		E	'E 'H	RE5604

						
BS5421	BS7204	BS7205	CJ142	CJ143	CJ863	CJ870L
Ref.Nr.: 31129059288	Ref.Nr.: 31124004359	Ref.Nr.: 31126754899	Ref.Nr.: 31126777852	Ref.Nr.: 31126752717	Ref.Nr.: 31121140398	Ref.Nr.: 31121094275
						
CJ870R	CTR5159	CTR5605	RE046	RE5604		
Ref.Nr.: 31121136530	Ref.Nr.: 31351127689	Ref.Nr.: 6Q0411315E	Ref.Nr.: 32111139315PA	Ref.Nr.: 32111096897PA		

Article Description			Fitting Position	Article No.
---------------------	---	---	------------------	-------------

Z4 [USA] Convertible

01/2003 → 12/2007

Rod/Strut, stabiliser	2.5 i, 3.0 24V, 3.0 si, 3.2 24V	Material: Steel	E	'E 'H	CTR5605
-----------------------	---------------------------------	-----------------	---	-------	---------

Z4 [USA] Coupe

01/2006 → 12/2009

Rod/Strut, stabiliser	3.0 si, 3.2 24V	Material: Steel	E	'E 'H	CTR5605
-----------------------	-----------------	-----------------	---	-------	---------

Z4 Coupe (E86)

03/2006 → 01/2009











Holder, control arm mounting	3.0 si, M	Hydro Bearing; Material: Aluminium	E	'E	BS7204
Holder, control arm mounting	3.0 si, M	Hydro Bearing; Material: Aluminium	E	'H	BS7205
Track Control Arm	3.0 si	Material: Aluminium; with ball joint, with fastening material, without rubber mounting; without holder	E	'H	CJ142
Track Control Arm	3.0 si	Material: Aluminium; with ball joint, with fastening material, without rubber mounting; without holder	E	'E	CJ143
Rod/Strut, stabiliser	3.0 si, M	Material: Steel	E	'E 'H	CTR5605



Z4 ROADSTER (E89)

05/2009 →

Track Control Arm	sDrive20i, sDrive23i, sDrive28i, sDrive30i, sDrive35i, sDrive35is		E	'E	CJ1149
Track Control Arm	sDrive20i, sDrive23i, sDrive28i, sDrive30i, sDrive35i, sDrive35is		E	'H	CJ1150
Rod/Strut, stabiliser	sDrive20i, sDrive23i, sDrive28i, sDrive30i, sDrive35i, sDrive35is	Material: Steel	E	'E	CTR5875L
Rod/Strut, stabiliser	sDrive20i, sDrive23i, sDrive28i, sDrive30i, sDrive35i, sDrive35is	Material: Steel	E	'H	CTR5875R



Track Control Arm	4.9	Material: Aluminium; with rubber mounting	E	'E	CJ1065L
Track Control Arm	4.9	Material: Aluminium; with rubber mounting	E	'H	CJ1065R

						
BS7204	BS7205	CJ1065L	CJ1065R	CJ1149	CJ1150	CJ142
Ref.Nr.: 31124004359	Ref.Nr.: 31126754899	Ref.Nr.: 31121141717	Ref.Nr.: 31121141718	Ref.Nr.: 31122405861	Ref.Nr.: 31126769802	Ref.Nr.: 3112677852
						
CJ143	CTR5605	CTR5875L	CTR5875R			
Ref.Nr.: 31126752717	Ref.Nr.: 6Q0411315E	Ref.Nr.: 31356765933	Ref.Nr.: 31356765934			

Article Description			Fitting Position	Article No.
AVEO Saloon (T200)			09/2003 → 12/2008	
Control Arm-/Trailing Arm Bush	1.6		E 'E 'H	BS8315
AVEO Hatchback (T250, T255)			04/2008 →	
Control Arm-/Trailing Arm Bush	1.2, 1.2 LPG, 1.4		E 'E 'H	BS8315
Track Control Arm	1.2, 1.4		E 'E	CJ269L
Track Control Arm	1.2, 1.4		E 'H	CJ269R
AVEO Saloon (T250, T255)			05/2005 → 12/2007	
Control Arm-/Trailing Arm Bush	1.2, 1.2 LPG, 1.4, 1.5, 1.6		E 'E 'H	BS8315
Track Control Arm	1.2, 1.4, 1.5		E 'E	CJ269L
Track Control Arm	1.2, 1.4, 1.5		E 'H	CJ269R
CORSA C Utility			01/2002 →	
Suspension Kit	1.4I,1.7DTI,1.8I		E 'E 'H	BS6102
Control Arm-/Trailing Arm Bush	1.4I,1.7DTI,1.8I		E 'E 'H	BS6103
Ball Joint	1.4I,1.7DTI,1.8I		E 'E 'H	CJ654
Tie Rod End	1.4I,1.7DTI,1.8I	Long	E 'E 'H	CTR5500
Rod/Strut, stabiliser	1.4I,1.7DTI,1.8I		E 'E 'H	CTR5771
Top Strut Mounting	1.4I,1.7DTI,1.8I	Shock Mounting Front	E 'E 'H	MO6848
Tie Rod Axle Joint	1.4I,1.7DTI,1.8I	285 mm P/S	E 'E 'H	RE056
Rack End	1.4I,1.7DTI,1.8I	310 mm M/S	E 'E 'H	RE1609
Tie Rod Axle Joint	1.4I,1.7DTI,1.8I	305 mm M/S	E 'E 'H	RE5499
Tie Rod Axle Joint	1.4I,1.7DTI,1.8I	280 mm M/S	E 'E 'H	RE5815

						
BS6102	BS6103	BS8315	CJ269L	CJ269R	CJ654	CTR5500
Ref.Nr.: 352309	Ref.Nr.: 24430103	Ref.Nr.: 96535088	Ref.Nr.: 96815893	Ref.Nr.: 96815894	Ref.Nr.: 9196394	Ref.Nr.: 324066
						
CTR5771	MO6848	RE056	RE1609	RE5499	RE5815	
Ref.Nr.: 90496116	Ref.Nr.: 344523	Ref.Nr.: 1603843	Ref.Nr.:	Ref.Nr.: 26087867	Ref.Nr.: 322158	

CHRYSLER

Article Description			Fitting Position	Article No.
CROSSFIRE			07/2003 → 12/2008	
Ball Joint	3.2, SRT-6		E	'E 'H CJ1028
CROSSFIRE Roadster			05/2004 → 12/2008	
Ball Joint	3.2, SRT-6		E	'E 'H CJ1028
VOYAGER Mk II (GS)			01/1995 → 03/2001	
Tie Rod End	2.0 i, 2.4 i, 2.5 TD, 3.0, 3.3 i, 3.8 i AWD		E	'E 'H CTR6107

CHRYSLER

	
CJ1028	CTR6107
Ref.Nr.: 2103330427	Ref.Nr.: 4797706

Article Description			Fitting Position	Article No.
---------------------	---	---	------------------	-------------

C4 I (LC_)

11/2004 → 07/2011

Rod/Strut, stabiliser	1.4 16V, 1.6 16V, 1.6 HDi, 2.0 16V, 2.0 HDi	Material: Steel	E	'E	'H	CTR6130
-----------------------	---	-----------------	---	----	----	---------

C4 Coupe (LA_)

11/2004 → 07/2011

Rod/Strut, stabiliser	1.4 16V, 1.6 16V, 1.6 HDi, 2.0 16V, 2.0 HDi	Material: Steel	E	'E	'H	CTR6130
-----------------------	---	-----------------	---	----	----	---------

CTR6130
Ref.Nr.: 508750

Article Description			Fitting Position	Article No.
---------------------	---	---	------------------	-------------

LANOS (KLAT)

05/1997 →

Ball Joint	1.5		E	'E	'H	CJ869
------------	-----	--	---	----	----	-------

MATIZ (KLYA)

09/1998 →

Track Control Arm	0.8		E	'E	'H	CJ1084
-------------------	-----	--	---	----	----	--------

NUBIRA (KLAJ)

05/1997 → 07/2003

Tie Rod End	1.6 16V, 2.0 16V, 2.0 CDX		E	'E	'H	CTR5141
Rod/Strut, stabiliser	1.6 16V, 2.0 16V, 2.0 CDX	01/1999 →; for OE: 96275798	E	'E	'H	CTR5891

NUBIRA Saloon (KLAJ)

05/1997 → 07/2003

Tie Rod End	1.5 SE, 1.6 16V, 2.0, 2.0 16V		E	'E	'H	CTR5141
Rod/Strut, stabiliser	1.5 SE, 1.6 16V, 2.0, 2.0 16V	01/1999 →; for OE: 96275798	E	'E	'H	CTR5891

NUBIRA Wagon (KLAJ)

05/1997 →

Tie Rod End	1.6 16V, 2.0 16V		E	'E	'H	CTR5141
Rod/Strut, stabiliser	1.6 16V, 2.0 16V	01/1999 →; for OE: 96275798	E	'E	'H	CTR5891





Article Description	 	Fitting Position	Article No.
---------------------	---	------------------	-------------



CHARADE

05/2011 →

Rod/Strut, stabiliser	1.33 16V	Material: Steel	E	E H	CTR6161
-----------------------	----------	-----------------	---	-----	---------

	
<p>CTR6161</p>	
<p>Ref.Nr.:</p>	

Article Description			Fitting Position	Article No.
DOBLO MPV (119_, 223_)			03/2001 →	
Ball Joint	1.2, 1.6 16V, 1.6 Natural Power, 1.9 D, 1.9 JTD	→ 09/2002	E	'E 'H CJ1045
DOBLO Cargo (223_)			03/2001 →	
Ball Joint	1.2, 1.6 16V, 1.9 D, 1.9 JTD	→ 09/2002	E	'E 'H CJ1045
PALIO (178BX)			04/1996 →	
Ball Joint	1.0, 1.2, 1.4, 1.4 CAT, 1.6 16V		E	'E 'H CJ1045
PALIO Weekend (178_)			02/2001 →	
Ball Joint	1.2, 1.6 16V, 1.9 D		E	'E 'H CJ1045
STRADA Pickup (178_)			06/1999 →	
Ball Joint	1.2, 1.3 D Multijet, 1.7 TD, 1.9 D, 1.9 JTD		E	'E 'H CJ1045
UNO (146_)			01/1983 → 06/2001	
Tie Rod End	1.0, 1.0iE, 1.3 Super Diesel, 1.3 Turbo i.e., 1.4 Turbo i.e., 1.6, 1.6R, 1.9D, 450.9, 451.0, 451.0, 451.0, 501.1, 501.0, 501.1, 551.0, 551.1, 601.1, 60 Diesel 1.7, 701.3, 70 i.e. 1.4, 70 S 1.4, 70 TD 1.4, 75 i.e. 1.5		E	'E 'H CTR5401
Top Strut Mounting	1.3 Super Diesel, 1.3 Turbo i.e., 1.9D, 450.9, 451.0, 451.0, 501.1, 501.1, 551.1, 601.1, 60 Diesel 1.7, 70 1.3, 70 i.e. 1.4, 70 S 1.4, 70 TD 1.4, 75 i.e. 1.5, 1.6 R	→ 10/1989	Z	'E 'H MO5809

		
CJ1045	CTR5401	MO5809
Ref.Nr.: 46543045	Ref.Nr.: 5958247	Ref.Nr.: 05960254

Article Description			Fitting Position	Article No.
---------------------	---	---	------------------	-------------

BANTAM

01/1994 → 12/2002

Ball Joint	1.3 1.6I		E	'E 'H	CJ926
Tie Rod End	1.3 1.6I		E	'E 'H	CTR5184
Tie Rod Axle Joint	1.3 1.6I	M/S	E	'E 'H	RE014

BANTAM













01/2003 →

Control Arm-/Trailing Arm Bush	1.3 XL,1.6I XLT,XLE,1.8DI XL	Control Arm Bush Rear ID 12/OD37/L62	E	'E 'H	BS6496
Control Arm-/Trailing Arm Bush	1.3 XL,1.6I XLT,XLE,1.8DI XL	Control Arm Bush FR ID12/OD66/L51	E	'E 'H	BS7411
Track Control Arm	1.3 XL,1.6I XLT,XLE,1.8DI XL	P/S	E	'E	CJ159L
Track Control Arm	1.3 XL,1.6I XLT,XLE,1.8DI XL	P/S	E	'H	CJ159R
Ball Joint	1.3 XL,1.6I XLT,XLE,1.8DI XL		E	'E 'H	CJ582
Tie Rod Axle Joint	1.3 XL,1.6I XLT,XLE,1.8DI XL	289 mm P/S	E	'E 'H	RE5571

BANTAM

01/1983 → 12/1986

Track Control Arm	1.3,1.4,1.6		E	'H	CJ843
Track Control Arm	1.3,1.4,1.6		E	'E	CJ844
Track Control Arm	1.3,1.4,1.6		E	'H	CJ964
Track Control Arm	1.3,1.4,1.6		E	'E	CJ965

						
BS6496	BS7411	CJ159L	CJ159R	CJ582	CJ843	CJ844
Ref.Nr.: 96FB3063AA	Ref.Nr.: 98FB3A262AA	Ref.Nr.: 1E0034350A	Ref.Nr.: 1003575	Ref.Nr.: 7152281	Ref.Nr.: 3246130	Ref.Nr.: 5021457
						
CJ926	CJ964	CJ965	CTR5184	RE014	RE5571	
Ref.Nr.: B00134550	Ref.Nr.: 1637182	Ref.Nr.: 1637185	Ref.Nr.: 8AB032280	Ref.Nr.: BF673224X	Ref.Nr.: 4342539	

Article Description			Fitting Position	Article No.
---------------------	---	---	------------------	-------------

B-MAX (JK)

10/2012 →

Rod/Strut, stabiliser	1.0 EcoBoost, 1.4, 1.4 LPG, 1.5 TDCi, 1.6 TDCi, 1.6 Ti	Material: Aluminium	E	'E	'H	CTR1418
Tie Rod Axle Joint	1.0 EcoBoost, 1.4, 1.4 LPG, 1.5 TDCi, 1.6 TDCi, 1.6 Ti		E	'E	'H	RE6092

B-MAX Van

10/2012 →

Rod/Strut, stabiliser	1.0 EcoBoost, 1.4, 1.5 TDCi, 1.6 TDCi, 1.6 Ti	Material: Aluminium	E	'E	'H	CTR1418
Tie Rod Axle Joint	1.0 EcoBoost, 1.4, 1.5 TDCi, 1.6 TDCi, 1.6 Ti		E	'E	'H	RE6092

C-MAX (DM2)

02/2007 → 09/2010

Ball Joint	1.6, 1.6TDCi, 1.8, 1.8Flexifuel, 1.8TDCi, 2.0, 2.0TDCi		E	'E	'H	CJ1259
Rod/Strut, stabiliser	1.6, 1.6 TDCi, 1.8, 1.8 Flexifuel, 2.0		E			CTR5923

COURIER

01/1986 → 12/1999

Ball Joint	1.6,1.8,2.0,2.2,2.5,3.0,3.4 STD XLT S/CAB,D/CAB	Upper	E	'E	'H	CJ918
Ball Joint	1.6,1.8,2.0,2.2,2.5,3.0,3.4 STD XLT S/CAB,D/CAB	Lower	E	'E	'H	CJ919
Tie Rod End	1.6,1.8,2.0,2.2,2.5,3.0,3.4 STD XLT S/CAB,D/CAB	Inner	E	'E	'H	CTR5338
Tie Rod End	1.6,1.8,2.0,2.2,2.5,3.0,3.4 STD XLT S/CAB,D/CAB	Outer	E	'E	'H	CTR5339

ECOSPORT

08/2012 →

Rod/Strut, stabiliser	1.5 TDCi, 1.5 Ti, 1.6, 2.0 4x4, EcoBoost 1.0	Material: Aluminium	E	'E	'H	CTR1418
Tie Rod Axle Joint	1.5 TDCi, 1.5 Ti, 1.6, 2.0 4x4, EcoBoost 1.0		E	'E	'H	RE6092

ESCORT CLASSIC (AAL, ABL)

10/1998 → 07/2000

Track Control Arm	1.6 16V, 1.8 TD		E		'H	CJ124
Track Control Arm	1.6 16V, 1.8 TD		E	'E		CJ125
Rod/Strut, stabiliser	1.6 16V, 1.8 TD	Material: Steel	E	'E	'H	CTR5318

FORD

						
CJ124	CJ125	CJ1259	CJ918	CJ919	CTR1418	CTR5318
Ref.Nr.: 91AB3042AD	Ref.Nr.: 95AB3051AB	Ref.Nr.: 1679388	Ref.Nr.:	Ref.Nr.: K9597	Ref.Nr.: 8V513B438AB	Ref.Nr.: YS413B438BA
						
CTR5338	CTR5339	CTR5923	RE6092			
Ref.Nr.:	Ref.Nr.:	Ref.Nr.: 3M513B438AB	Ref.Nr.: 8V513L519AA			

Article Description			Fitting Position	Article No.
---------------------	---	---	------------------	-------------

ESCORT CLASSIC Turnier (ANL)

02/1999 → 07/2000

Track Control Arm	1.6 16V, 1.8 TD		E		H	CJ124
Track Control Arm	1.6 16V, 1.8 TD		E	E		CJ125
Rod/Strut, stabiliser	1.6 16V, 1.8 TD	Material: Steel	E	E	H	CTR5318

ESCORT Mk III (GAA)

09/1980 → 07/1986

Track Control Arm	1.1, 1.3, 1.6, 1.6D, 1.6i, 1.6RS Turbo, 1.6XR3i, RS 1600i	for OE: 6087888	E		H	CJ843
Track Control Arm	1.1, 1.3, 1.6, 1.6D, 1.6i, 1.6RS Turbo, 1.6XR3i, RS 1600i	05/1983 →	E	E		CJ844

ESCORT Mk III Convertible (ALD)

09/1983 → 12/1985

Track Control Arm	1.3, 1.6, 1.6 i	for OE: 6087888	E		H	CJ843
Track Control Arm	1.3, 1.6, 1.6 i		E	E		CJ844

ESCORT Mk III Estate (AWA)

09/1980 → 12/1985

Track Control Arm	1.1, 1.3, 1.6, 1.6 D	for OE: 6087888	E		H	CJ843
Track Control Arm	1.1, 1.3, 1.6, 1.6 D	05/1983 →	E	E		CJ844

ESCORT Mk IV (GAF, AWF, ABFT)

10/1985 → 10/1990

Track Control Arm	1.1, 1.4	→ 12/1985; for OE: 6087888	E		H	CJ843
Track Control Arm	1.1, 1.4		E	E		CJ844
Track Control Arm	1.1, 1.3, 1.4, 1.6, 1.6D, 1.6i, 1.6TurboRS, 1.6XR3i, 1.8D	01/1986 →; for OE: 1637182, 1637183	E		H	CJ964
Track Control Arm	1.1, 1.3, 1.4, 1.6, 1.6D, 1.6i, 1.6TurboRS, 1.6XR3i, 1.8D	01/1986 →; for OE: 1637184, 1637185	E	E		CJ965

ESCORT Mk IV Estate (AWF, AVF)

10/1985 → 10/1990

Track Control Arm	1.1, 1.4	→ 12/1985; for OE: 6087888	E		H	CJ843
Track Control Arm	1.1, 1.4		E	E		CJ844
Track Control Arm	1.1, 1.3, 1.4, 1.6, 1.6 D, 1.6 i, 1.8 D	01/1986 →; for OE: 1637182, 1637183	E		H	CJ964
Track Control Arm	1.1, 1.3, 1.4, 1.6, 1.6 D, 1.6 i, 1.8 D	01/1986 →; for OE: 1637184, 1637185	E	E		CJ965

ESCORT Mk V (GAL)

07/1990 → 12/1992

Track Control Arm	1.3, 1.4, 1.6, 1.8 16V XR3i, 1.8 D, RS 2000		E		H	CJ124
Track Control Arm	1.3, 1.4, 1.6, 1.8 16V XR3i, 1.8 D, RS 2000		E	E		CJ125
Rod/Strut, stabiliser	1.3, 1.4, 1.6, 1.8 16V XR3i, 1.8 D, RS 2000	for OE: 1661237; Material: Steel	E	E	H	CTR5318
Tie Rod Axle Joint	RS 2000		E	E	H	RE5450

ESCORT Mk V Convertible (ALL)









07/1990 → 12/1992

Track Control Arm	1.4, 1.6, 1.8 16V XR3i		E		H	CJ124
Track Control Arm	1.4, 1.6, 1.8 16V XR3i		E	E		CJ125
Rod/Strut, stabiliser	1.4, 1.6, 1.8 16V XR3i	for OE: 1661237; Material: Steel	E	E	H	CTR5318

ESCORT Mk V Estate (GAL, AVL)

07/1990 → 12/1992

Track Control Arm	1.3, 1.4, 1.6, 1.8 16V, 1.8 D		E		H	CJ124
Track Control Arm	1.3, 1.4, 1.6, 1.8 16V, 1.8 D		E	E		CJ125
Rod/Strut, stabiliser	1.3, 1.4, 1.6, 1.8 16V, 1.8 D	for OE: 1661237; Material: Steel	E	E	H	CTR5318

						
CJ124	CJ125	CJ843	CJ844	CJ964	CJ965	CTR5318
Ref.Nr.: 91AB3042AD	Ref.Nr.: 95AB3051AB	Ref.Nr.: 3246130	Ref.Nr.: 5021457	Ref.Nr.: 1637182	Ref.Nr.: 1637185	Ref.Nr.: YS413B438BA
						
RE5450						
Ref.Nr.: 6135757						

Article Description			Fitting Position	Article No.
---------------------	---	---	------------------	-------------

ESCORT Mk VI (GAL)

09/1992 → 01/1995

Track Control Arm	1.3, 1.4, 1.6i 16V, 1.8 16V XR3i, 1.8D, 1.8i 16V, 1.8TD, 1.8 XR3i 16V 4x4, RS 2000, RS 2000 4x4		E		H	CJ124
Track Control Arm	1.3, 1.4, 1.6i 16V, 1.8 16V XR3i, 1.8D, 1.8i 16V, 1.8TD, 1.8 XR3i 16V 4x4, RS 2000, RS 2000 4x4		E	E		CJ125
Rod/Strut, stabiliser	1.3, 1.4, 1.6i 16V, 1.8D, 1.8i 16V, 1.8TD, 1.8 16V XR3i, 1.8 XR3i 16V 4x4, RS 2000, RS 2000 4x4, RS Cosworth 4x4	for OE: 1661237; Material: Steel	E	E	H	CTR5318
Tie Rod Axle Joint	RS 2000, RS 2000 4x4, RS Cosworth 4x4		E	E	H	RE5450

ESCORT Mk VI Convertible (ALL)

12/1992 → 01/1995

Track Control Arm	1.4, 1.4 i, 1.6 16V XR3i, 1.6 i 16V, 1.8 16V XR3i		E		H	CJ124
Track Control Arm	1.4, 1.4 i, 1.6 16V XR3i, 1.6 i 16V, 1.8 16V XR3i		E	E		CJ125
Rod/Strut, stabiliser	1.4, 1.4 i, 1.6 16V XR3i, 1.6 i 16V, 1.8 16V XR3i	for OE: 1661237; Material: Steel	E	E	H	CTR5318

ESCORT Mk VI Estate (GAL)

09/1992 → 01/1995

Track Control Arm	1.3, 1.4, 1.6 i 16V, 1.8 D, 1.8 i 16V, 1.8 TD		E		H	CJ124
Track Control Arm	1.3, 1.4, 1.6 i 16V, 1.8 D, 1.8 i 16V, 1.8 TD		E	E		CJ125
Rod/Strut, stabiliser	1.3, 1.4, 1.6 i 16V, 1.8 D, 1.8 i 16V, 1.8 TD	for OE: 1661237; Material: Steel	E	E	H	CTR5318

ESCORT Mk VI Saloon (GAL)

08/1993 → 01/1995

Track Control Arm	1.3, 1.4, 1.6 i 16V, 1.8 D, 1.8 i 16V, 1.8 TD		E		H	CJ124
Track Control Arm	1.3, 1.4, 1.6 i 16V, 1.8 D, 1.8 i 16V, 1.8 TD		E	E		CJ125
Rod/Strut, stabiliser	1.3, 1.4, 1.6 i 16V, 1.8 D, 1.8 i 16V, 1.8 TD	for OE: 1661237; Material: Steel	E	E	H	CTR5318

ESCORT Mk VII (GAL, AAL, ABL)

01/1995 → 10/1998

Track Control Arm	1.3, 1.4, 1.6 16V, 1.6 16V 4x4, 1.6i 16V, 1.8 16V, 1.8 D, 1.8 TD, 1.8 Turbo D, RS 2000, RS 2000 4x4		E		H	CJ124
Track Control Arm	1.3, 1.4, 1.6 16V, 1.6 16V 4x4, 1.6i 16V, 1.8 16V, 1.8 D, 1.8 TD, 1.8 Turbo D, RS 2000, RS 2000 4x4		E	E		CJ125
Rod/Strut, stabiliser	1.3, 1.4, 1.6 16V, 1.6 16V 4x4, 1.6i 16V, 1.8 16V, 1.8 D, 1.8 TD, 1.8 Turbo D, RS 2000, RS 2000 4x4, RS Cosworth 4x4	Material: Steel	E	E	H	CTR5318

ESCORT Mk VII Convertible (ALL)

02/1995 → 08/2000

Track Control Arm	1.4, 1.6 16V XR3i, 1.8 16V XR3i, 1.8 TD, 1.8 Turbo D		E		H	CJ124
Track Control Arm	1.4, 1.6 16V XR3i, 1.8 16V XR3i, 1.8 TD, 1.8 Turbo D		E	E		CJ125
Rod/Strut, stabiliser	1.4, 1.6 16V XR3i, 1.8 16V XR3i, 1.8 TD, 1.8 Turbo D	Material: Steel	E	E	H	CTR5318

ESCORT Mk VII Saloon (GAL, AFL)

01/1995 → 02/1999

Track Control Arm	1.3, 1.4, 1.6 i 16V, 1.8 16V, 1.8 D, 1.8 TD, 1.8 Turbo D		E		H	CJ124
Track Control Arm	1.3, 1.4, 1.6 i 16V, 1.8 16V, 1.8 D, 1.8 TD, 1.8 Turbo D		E	E		CJ125
Rod/Strut, stabiliser	1.3, 1.4, 1.6 i 16V, 1.8 16V, 1.8 D, 1.8 TD, 1.8 Turbo D	Material: Steel	E	E	H	CTR5318

ESCORT Mk VII Estate (GAL, ANL)





01/1995 → 02/1999

Track Control Arm	1.3, 1.4, 1.6 16V, 1.6i 16V, 1.8 16V, 1.8D, 1.8TD, 1.8 Turbo		E		H	CJ124
Track Control Arm	1.3, 1.4, 1.6 16V, 1.6i 16V, 1.8 16V, 1.8D, 1.8TD, 1.8 Turbo		E	E		CJ125
Rod/Strut, stabiliser	1.3, 1.4, 1.6 16V, 1.6i 16V, 1.8 16V, 1.8D, 1.8TD, 1.8 Turbo	Material: Steel	E	E	H	CTR5318

FIESTA Mk IV (JA_, JB_)

08/1995 → 01/2002

Control Arm-/Trailing Arm Bush	1.0i, 1.25i 16V, 1.3i, 1.4i 16V, 1.6 16V Sport, 1.8 D, 1.8 DI		E	E	H	BS6496
--------------------------------	---	--	---	---	---	--------

				
BS6496	CJ124	CJ125	CTR5318	RE5450
Ref.Nr.: 96FB3063AA	Ref.Nr.: 91AB3042AD	Ref.Nr.: 95AB3051AB	Ref.Nr.: YS413B438BA	Ref.Nr.: 6135757

Article Description			Fitting Position	Article No.
---------------------	---	---	------------------	-------------

FIESTA Mk IV (JA_, JB_)

08/1995 → 01/2002

Control Arm-/Trailing Arm Bush	1.0 i, 1.25 i 16V, 1.3 i, 1.4 i 16V, 1.6 16V Sport, 1.8 D, 1.8 DI		E	'E	'H	BS7411
Track Control Arm	1.0 i, 1.1, 1.25 i 16V, 1.3 i, 1.4 i 16V, 1.8 D	→ 05/1998; for vehicles with power steering	E	'E		CJ159L
Track Control Arm	1.0 i, 1.1, 1.25 i 16V, 1.3 i, 1.4 i 16V, 1.8 D	→ 05/1998; for vehicles with power steering	E		'H	CJ159R
Ball Joint	1.0 i, 1.25 i 16V, 1.3 i, 1.4 i 16V, 1.6 16V Sport, 1.8 D, 1.8 DI	with fastening material	E	'E	'H	CJ582
Rod/Strut, stabiliser	1.0 i, 1.25 i 16V, 1.3 i, 1.4 i 16V, 1.6 16V Sport, 1.8 D, 1.8 DI	for OE: 1004018; Material: Steel	E	'E	'H	CTR5318

FIESTA V (JH_, JD_)

11/2001 → 06/2008

Rod/Strut, stabiliser	1.25 16V, 1.3, 1.4 16V, 1.4 TDCi, 1.6 16V, 1.6 TDCi, ST150		E	'E	'H	CTR6172
Tie Rod Axle Joint	1.25 16V, 1.3, 1.4 16V, 1.4 TDCi, 1.6 16V, 1.6 TDCi, ST150		E	'E	'H	RE5571

FIESTA VI

06/2008 →

Rod/Strut, stabiliser	1.0, 1.0 EcoBoost, 1.0 Sport, 1.25, 1.4, 1.4 LPG, 1.4 TDCi, 1.5 TDCi, 1.6, 1.6 ST, 1.6 TDCi, 1.6 Ti	Material: Aluminium	E	'E	'H	CTR1418
Tie Rod Axle Joint	1.0, 1.0 EcoBoost, 1.0 Sport, 1.25, 1.4, 1.4 LPG, 1.4 TDCi, 1.5 TDCi, 1.6, 1.6 TDCi, 1.6 Ti	not for country-spec. model: Russia, Turkey; Prod. date 05.11.2012→	E	'E	'H	RE6092

FIESTA Saloon

10/2012 →

Rod/Strut, stabiliser	1.25	Material: Aluminium	E	'E	'H	CTR1418
Tie Rod Axle Joint	1.25	not for country-spec. model: Russia, Turkey; Prod. date 05.11.2012→	E	'E	'H	RE6092

FOCUS (DAW, DBW)

10/1998 → 11/2004

Rod/Strut, stabiliser	1.4 16V, 1.6 16V, 1.8 16V, 1.8 DI/TDDi, 1.8 Turbo DI/TDDi, 1.8 TDCi, 2.0 16V, ST170	for OE: 1061631; Material: Steel	E	'E	'H	CTR5318
-----------------------	---	----------------------------------	---	----	----	---------

FOCUS Saloon (DFW)

02/1999 → 11/2004

Rod/Strut, stabiliser	1.4 16V, 1.6 16V, 1.8 16V, 1.8 Turbo DI/TDDi, 1.8 TDCi, 2.0 16V	for OE: 1061631; Material: Steel	E	'E	'H	CTR5318
-----------------------	---	----------------------------------	---	----	----	---------

FOCUS II (DA_)

07/2004 → 09/2012

Ball Joint	1.4, 1.6, 1.6 TDCi, 1.6 Ti, 1.8 TDCi, 2.0, 2.0 TDCi, 2.5 ST	Prod. date 27.02.2006→	E	'E	'H	CJ1259	
Tie Rod End	1.4, 1.6, 1.6 TDCi, 1.6 Ti, 1.8 TDCi, 2.0, 2.0 TDCi, 2.5 ST		E	'E		CTR5921L	
Tie Rod End	1.4, 1.6, 1.6 TDCi, 1.6 Ti, 1.8 TDCi, 2.0, 2.0 TDCi, 2.5 ST		E		'H	CTR5921R	
Rod/Strut, stabiliser	1.4, 1.6, 1.6 TDCi, 1.6 Ti, 1.8 Flexifuel, 1.8 TDCi, 2.0, 2.0 TDCi, 2.5 ST		E			CTR5923	
Rod/Strut, stabiliser	1.4, 1.6, 1.6 TDCi, 1.6 Ti, 1.8 Flexifuel, 1.8 TDCi, 2.0, 2.0 TDCi, 2.5 ST			Z	'E	'H	CTR6191

FOCUS II Saloon (DA_)













04/2005 → 09/2012



Ball Joint	1.4, 1.6, 1.6 TDCi, 1.6 Ti, 1.8 TDCi, 2.0, 2.0 TDCi	Prod. date 27.02.2006→	E	'E	'H	CJ1259	
Rod/Strut, stabiliser	1.4, 1.6, 1.6 TDCi, 1.6 Ti, 1.8 Flexifuel, 1.8 TDCi, 2.0, 2.0 TDCi		E			CTR5923	
Rod/Strut, stabiliser	1.4, 1.6, 1.6 TDCi, 1.6 Ti, 1.8 Flexifuel, 1.8 TDCi, 2.0, 2.0 TDCi			Z	'E	'H	CTR6191

FOCUS C-MAX











10/2003 → 03/2007

Ball Joint	1.6, 1.6 TDCi, 1.6 Ti, 1.8, 1.8 Flexifuel, 1.8 TDCi, 2.0, 2.0 TDCi	Prod. date 27.02.2006→	E	'E	'H	CJ1259
Tie Rod End	1.6, 1.6 TDCi, 1.6 Ti, 1.8, 1.8 Flexifuel, 1.8 TDCi, 2.0, 2.0 TDCi		E	'E		CTR5921L
Tie Rod End	1.6, 1.6 TDCi, 1.6 Ti, 1.8, 1.8 Flexifuel, 1.8 TDCi, 2.0, 2.0 TDCi		E		'H	CTR5921R
Rod/Strut, stabiliser	1.6, 1.6 TDCi, 1.6 Ti, 1.8, 1.8 Flexifuel, 1.8 TDCi, 2.0, 2.0 TDCi		E			CTR5923

						
BS7411	CJ1259	CJ159L	CJ159R	CJ582	CTR1418	CTR5318
Ref.Nr.: 98FB3A262AA	Ref.Nr.: 1679388	Ref.Nr.: 1E0034350A	Ref.Nr.: 1003575	Ref.Nr.: 7152281	Ref.Nr.: 8V513B438AB	Ref.Nr.: YS413B438BA
						
CTR5921R	CTR5923	CTR6172	CTR6191	RE5571	RE6092	
Ref.Nr.: 1317446	Ref.Nr.: 3M513B438AB	Ref.Nr.: 2S613B438AE	Ref.Nr.: 1310333	Ref.Nr.: 4342539	Ref.Nr.: 8V513L519AA	

Article Description			Fitting Position	Article No.
FOCUS C-MAX				10/2003 → 03/2007
Rod/Strut, stabiliser	1.6 TDCi, 1.6 Ti, 1.8, 1.8 Flexifuel, 1.8 TDCi, 2.0, 2.0 TDCi		Z 'E 'H	CTR6191
FUSION (JU_)				08/2002 → 12/2012
Rod/Strut, stabiliser	1.25, 1.4, 1.4 TDCi, 1.6, 1.6 TDCi		E 'E 'H	CTR6172
Tie Rod Axle Joint	1.25, 1.4, 1.4 TDCi, 1.6, 1.6 TDCi		E 'E 'H	RE5571
IKON				01/2001 → 12/2006
Control Arm-Trailing Arm Bush	1.3i LX,1.6i,LX,CLX	Front Control Arm Bush Rear ID 12/OD37/L62	E 'E 'H	BS6496
Control Arm-Trailing Arm Bush	1.3i LX,1.6i,LX,CLX	Control Arm Bush Front ID12/OD66/L51	E 'E 'H	BS7411
Track Control Arm	1.3i LX,1.6i,LX,CLX	P/S	E 'E	CJ159L
Track Control Arm	1.3i LX,1.6i,LX,CLX	P/S	E 'H	CJ159R
Ball Joint	1.3i LX,1.6i,LX,CLX		E 'E 'H	CJ582
Tie Rod Axle Joint	1.3i LX,1.6i,LX,CLX	P/S	E 'E 'H	RE5571
KA (RB_)				09/1996 → 11/2008
Ball Joint	1.0 i, 1.3 i, 1.6 i	with fastening material	E 'E 'H	CJ582
Rod/Strut, stabiliser	1.0 i, 1.3 i, 1.6 i	for OE: 1661237; Material: Steel	E 'E 'H	CTR5318
LAZER/TRACER				01/1986 → 12/2002
Ball Joint	1.3,1.5,1.6,1.6i		E 'E 'H	CJ926
Tie Rod End	1.3,1.5,1.6,1.6i		E 'E 'H	CTR5184
Tie Rod Axle Joint	1.3,1.5,1.6,1.6i	M/S	E 'E 'H	RE014

FORD

						
BS6496	BS7411	CJ159L	CJ159R	CJ582	CJ926	CTR5184
Ref.Nr.: 96FB3063AA	Ref.Nr.: 98FB3A262AA	Ref.Nr.: 1E0034350A	Ref.Nr.: 1003575	Ref.Nr.: 7152281	Ref.Nr.: B00134550	Ref.Nr.: 8AB032280
						
CTR5318	CTR6172	CTR6191	RE014	RE5571		
Ref.Nr.: YS413B438BA	Ref.Nr.: 2S613B438AE	Ref.Nr.: 1310333	Ref.Nr.: BF673224X	Ref.Nr.: 4342539		

Article Description			Fitting Position	Article No.
---------------------	---	---	------------------	-------------

METEOR

01/1986 → 12/1995

Ball Joint	1.3,1.4,1.5,1.6,2.0,GL,GLS,GLE,GLI		E	'E 'H	CJ926
Tie Rod End	1.3,1.4,1.5,1.6,2.0,GL,GLS,GLE,GLI		E	'E 'H	CTR5184
Tie Rod Axle Joint	1.3,1.4,1.5,1.6,2.0,GL,GLS,GLE,GLI	M/S	E	'E 'H	RE014

RANGER (ER, EQ)

10/1999 → 06/2006

Tie Rod End	2.3 4x4, 2.5 D, 2.5 D 4x4, 2.5 TD 4x4		E	'E 'H	CTR5335
-------------	---------------------------------------	--	---	-------	---------

RANGER 2X4 STD

01/1999 → 12/2009

Ball Joint	1.8,2.2,2.5TD,XL,XLT,4.0 V6,XLE,SUPERCAB,S/CAB,D/CAB	Upper	E	'E 'H	CJ918
Ball Joint	1.8,2.2,2.5TD,XL,XLT,4.0 V6,XLE,SUPERCAB,S/CAB,D/CAB	Lower	E	'E 'H	CJ919
Tie Rod End	1.8,2.2,2.5TD,XL,XLT,4.0 V6,XLE,SUPERCAB,S/CAB,D/CAB	Inner	E	'E 'H	CTR5338
Tie Rod End	1.8,2.2,2.5TD,XL,XLT,4.0 V6,XLE,SUPERCAB,S/CAB,D/CAB	Outer	E	'E 'H	CTR5339

SIERRA Hatchback (GBC)











08/1982 → 12/1986

Tie Rod Axle Joint	1.3, 1.6, 1.8, 2.0, 2.0 i, 2.3, 2.3 D, 2.8 XR 4x4, 2.8 XR4i	for OE: 6131083	E	'E 'H	RE5407
Tie Rod Axle Joint	1.6		E	'E 'H	RE5407
Tie Rod Axle Joint	2.8 XR4i	for left-hand drive vehicles	E	'E 'H	RE5450

RANGER 4X4/HI-TRAIL

01/1999 → 12/2007

Ball Joint	2.5TD,XL,XLT,4.0 V6,XLE,SUPERCAB,S/CAB,D/CAB	Upper	E	'E 'H	CJ918
------------	--	-------	---	-------	-------

						
CJ918	CJ919	CJ926	CTR5184	CTR5335	CTR5338	CTR5339
Ref.Nr.:	Ref.Nr.: K9597	Ref.Nr.: B00134550	Ref.Nr.: 8AB032280	Ref.Nr.: XM343289BA	Ref.Nr.:	Ref.Nr.:
						
RE014	RE5407	RE5450				
Ref.Nr.: BF673224X	Ref.Nr.: 6134277	Ref.Nr.: 6135757				

Article Description			Fitting Position	Article No.
---------------------	---	---	------------------	-------------

RANGER 4X4/HI-TRAIL

01/2007 → 12/2014

Ball Joint	2.5TD,XL,XLT,4.0 V6,XLE,SUPERCAB,S/CAB,D/CAB	Lower	E	'E	'H	CJ1205
Ball Joint	2.5TD,XL,XLT,4.0 V6,XLE,SUPERCAB,S/CAB,D/CAB	Upper	E	'E	'H	CJ918
Ball Joint	2.5TD,XL,XLT,4.0 V6,XLE,SUPERCAB,S/CAB,D/CAB	Hi Trail Lower	E	'E	'H	CJ983
Tie Rod End	2.5TD,XL,XLT,4.0 V6,XLE,SUPERCAB,S/CAB,D/CAB	Hi Trail Inner Alt	E	'E	'H	CTR5308
Tie Rod End	2.5TD,XL,XLT,4.0 V6,XLE,SUPERCAB,S/CAB,D/CAB	Inner	E	'E	'H	CTR5308
Tie Rod End	2.5TD,XL,XLT,4.0 V6,XLE,SUPERCAB,S/CAB,D/CAB	Outer	E	'E	'H	CTR5335
Tie Rod End	2.5TD,XL,XLT,4.0 V6,XLE,SUPERCAB,S/CAB,D/CAB	Inner	E	'E	'H	CTR5984

SIERRA Estate (BNC)

08/1982 → 12/1986

Tie Rod Axle Joint	1.6, 1.8, 2.0, 2.3, 2.3 D, 2.8 XR4i	for OE: 6131083	E	'E	'H	RE5407
--------------------	-------------------------------------	-----------------	---	----	----	--------

SIERRA (GBG, GB4)

01/1987 → 02/1993

Tie Rod Axle Joint	1.6, 1.6i, 1.8, 1.8TD, 2.0, 2.0 4x4, 2.0i, 2.0i CAT, 2.3D, 2.9 4x4, 2.9 i	for OE: 6131083	E	'E	'H	RE5407
Tie Rod Axle Joint	1.8 TD, 2.3 D, 2.9 i	for left-hand drive vehicles	E	'E	'H	RE5450

SIERRA Hatchback (GBC, GBG)

01/1987 → 02/1993

Tie Rod Axle Joint	1.6, 1.6i, 1.8, 1.8TD, 2.0, 2.0 16V Cosworth 4x4, 2.0 16V Cosworth 4x4 CAT, 2.0i, 2.0i CAT, 2.0 RSCosworth, 2.3D, 2.8 i XR 4x4, 2.9 i, 2.9 i XR 4x4	for OE: 6131083	E	'E	'H	RE5407
Tie Rod Axle Joint	2.0 i		E	'E	'H	RE5407
Tie Rod Axle Joint	1.8 TD, 2.3 D, 2.8 i XR 4x4, 2.9 i	for left-hand drive vehicles	E	'E	'H	RE5450

SIERRA Estate (BNG)

01/1987 → 02/1993

Tie Rod Axle Joint	1.6, 1.6i, 1.8, 1.8TD, 2.0, 2.0 4x4, 2.0i, 2.0i CAT, 2.3D, 2.8 4x4, 2.9, 2.9 4x4, 2.9 i	for OE: 6131083	E	'E	'H	RE5407
Tie Rod Axle Joint	1.8 TD, 2.3 D, 2.8 4x4, 2.9	for left-hand drive vehicles	E	'E	'H	RE5450

TOURNEO COURIER Kombi

02/2014 →

Rod/Strut, stabiliser	1.0 EcoBoost, 1.5 TDCi, 1.6 TDCi	Material: Aluminium	E	'E	'H	CTR1418
Tie Rod Axle Joint	1.0 EcoBoost, 1.5 TDCi, 1.6 TDCi		E	'E	'H	RE6092

TRANSIT COURIER Box











02/2014 →

Rod/Strut, stabiliser	1.0 EcoBoost, 1.5 TDCi, 1.6 TDCi	Material: Aluminium	E	'E	'H	CTR1418
Tie Rod Axle Joint	1.0 EcoBoost, 1.5 TDCi, 1.6 TDCi		E	'E	'H	RE6092

TRANSIT COURIER Kombi

02/2014 →

Rod/Strut, stabiliser	1.0 EcoBoost, 1.5 TDCi, 1.6 TDCi	Material: Aluminium	E	'E	'H	CTR1418
Tie Rod Axle Joint	1.0 EcoBoost, 1.5 TDCi, 1.6 TDCi		E	'E	'H	RE6092

						
CJ1205	CJ918	CJ983	CTR1418	CTR5308	CTR5335	CTR5984
Ref.Nr.: UR6134550	Ref.Nr.:	Ref.Nr.: 8AU334510	Ref.Nr.: 8V513B438AB	Ref.Nr.: 6M343280AA	Ref.Nr.: XM343289BA	Ref.Nr.: UR5632250
						
RE5407	RE5450	RE6092				
Ref.Nr.: 6134277	Ref.Nr.: 6135757	Ref.Nr.: 8V513L519AA				

Article Description			Fitting Position	Article No.
----------------------------	---	---	-------------------------	--------------------

FOTON 2.2 P/VAN,BUS

01/2007 →

Ball Joint	2,2	Lower Alternative	E	'E	'H	CJ281
Ball Joint	2,2	Lower	E	'E	'H	CJ931
Tie Rod End	2,2	Outer 17 mm	E	'E	'H	CTR5005
Tie Rod End	2,2	Outer 15 mm	E	'E	'H	CTR5005A
Tie Rod Axle Joint	2,2	17 mm	E	'E	'H	RE049
Tie Rod Axle Joint	2,2	15 mm	E	'E	'H	RE188

					
<p>CJ281</p> <p>Ref.Nr.: 4333029175</p>	<p>CJ931</p> <p>Ref.Nr.: 4333029125</p>	<p>CTR5005</p> <p>Ref.Nr.: 4504669055</p>	<p>CTR5005A</p> <p>Ref.Nr.: 4504629325</p>	<p>RE049</p> <p>Ref.Nr.: 4550329255</p>	<p>RE188</p> <p>Ref.Nr.: 4550329565</p>

GONOW

Article Description			Fitting Position	Article No.
---------------------	---	---	------------------	-------------

X-SPACE

01/2007 →

Ball Joint	2.2I	Upper	E	E	H	CJ933
Ball Joint	2.2I	Lower	E	E	H	CJ934

GONOW

		
<p>CJ933</p>	<p>CJ934</p>	
<p>Ref.Nr.: 4335039035</p>	<p>Ref.Nr.: 4333039165</p>	

Article Description			Fitting Position	Article No.
---------------------	---	---	------------------	-------------

GWM 2.2

01/2007 →

Ball Joint	2,2	Upper	E	'E	'H	CJ933
Ball Joint	2,2	Lower	E	'E	'H	CJ934

	
<p>CJ933</p> <p>Ref.Nr.: 4335039035</p>	<p>CJ934</p> <p>Ref.Nr.: 4333039165</p>

HONDA

Article Description			Fitting Position	Article No.
---------------------	---	---	------------------	-------------

BALLADE

01/1989 → 12/1996

Ball Joint	150I,160I,180I,ENCORE,LUXLINE,SPREELINE,V-TEC	Lower	E	'E	'H	CJ962
Ball Joint	150I,160I,180I,ENCORE,LUXLINE,SPREELINE,V-TEC	Upper	E	'E	'H	CJ967
Tie Rod End	150I,160I,180I,ENCORE,LUXLINE,SPREELINE,V-TEC		E	'E		CTR5345L
Tie Rod End	150I,160I,180I,ENCORE,LUXLINE,SPREELINE,V-TEC		E		'H	CTR5345R
Rod/Strut, stabiliser	150I,160I,180I,ENCORE,LUXLINE,SPREELINE,V-TEC		E	'E	'H	CTR5552

BALLADE

01/1992 → 12/2000

Track Control Arm	150I,160I,180I,ENCORE,LUXLINE,SPREELINE,V-TEC		E	'E		CJ610L
Track Control Arm	150I,160I,180I,ENCORE,LUXLINE,SPREELINE,V-TEC		E		'H	CJ610R
Ball Joint	150I,160I,180I,ENCORE,LUXLINE,SPREELINE,V-TEC	Lower	E	'E	'H	CJ962
Ball Joint	150I,160I,180I,ENCORE,LUXLINE,SPREELINE,V-TEC	Upper	E	'E	'H	CJ967
Tie Rod End	150I,160I,180I,ENCORE,LUXLINE,SPREELINE,V-TEC		E	'E		CTR5345L
Tie Rod End	150I,160I,180I,ENCORE,LUXLINE,SPREELINE,V-TEC		E		'H	CTR5345R
Rod/Strut, stabiliser	150I,160I,180I,ENCORE,LUXLINE,SPREELINE,V-TEC		E	'E	'H	CTR5552
Tie Rod Axle Joint	150I,160I,180I,ENCORE,LUXLINE,SPREELINE,V-TEC		E	'E	'H	RE071

CIVIC

01/1996 → 12/2000

Track Control Arm	150I,160I,180I,ENCORE,LUXLINE,SPREELINE,V-TEC		E	'E		CJ610L
Track Control Arm	150I,160I,180I,ENCORE,LUXLINE,SPREELINE,V-TEC		E		'H	CJ610R
Ball Joint	150I,160I,180I,ENCORE,LUXLINE,SPREELINE,V-TEC	Lower	E	'E	'H	CJ962
Ball Joint	150I,160I,180I,ENCORE,LUXLINE,SPREELINE,V-TEC	Upper	E	'E	'H	CJ967
Tie Rod End	150I,160I,180I,ENCORE,LUXLINE,SPREELINE,V-TEC		E	'E		CTR5345L
Tie Rod End	150I,160I,180I,ENCORE,LUXLINE,SPREELINE,V-TEC		E		'H	CTR5345R
Rod/Strut, stabiliser	150I,160I,180I,ENCORE,LUXLINE,SPREELINE,V-TEC		E	'E	'H	CTR5552
Tie Rod Axle Joint	150I,160I,180I,ENCORE,LUXLINE,SPREELINE,V-TEC		E	'E	'H	RE071

CIVIC

01/2000 → 12/2005

Tie Rod Axle Joint	150I,170I,1.8I,2.0I,2.2I, V-TEC		E	'E	'H	RE5908
--------------------	---------------------------------	--	---	----	----	--------

CR-V

01/1997 → 12/2003

Ball Joint	2,0	Lower	E	'E	'H	CJ962
Tie Rod End	2,0		E	'E		CTR5345L
Tie Rod End	2,0		E		'H	CTR5345R
Rod/Strut, stabiliser	2,0		E	'E	'H	CTR5552

CRX

01/1991 → 12/1993

Ball Joint	1,6	Lower	E	'E	'H	CJ962
Ball Joint	1,6	Upper	E	'E	'H	CJ967
Tie Rod End	1,6		E	'E		CTR5345L
Tie Rod End	1,6		E		'H	CTR5345R
Rod/Strut, stabiliser	1,6		E	'E	'H	CTR5552
Tie Rod Axle Joint	1,6		E	'E	'H	RE071

						
CJ610L	CJ610R	CJ962	CJ967	CTR5345L	CTR5345R	CTR5552
Ref.Nr.: 51460S01023	Ref.Nr.: 51450S01023	Ref.Nr.: 51220SH3003	Ref.Nr.:	Ref.Nr.: 53560SH3003	Ref.Nr.: 53540SH3003	Ref.Nr.: 51320S04003
						
RE071	RE5908					
Ref.Nr.: 53010SR3010	Ref.Nr.: 53010S04000					

Article Description			Fitting Position	Article No.
---------------------	---	---	------------------	-------------

ACCENT

01/1994 → 12/2006

Ball Joint	1.3LS,XS,1.5 CSI,LS,RSI		E	'E 'H	CJ1011
Tie Rod End	1.3LS,XS,1.5 CSI,LS,RSI		E	'E 'H	CTR5474

ELANTRA J2

01/1995 → 12/2000

Ball Joint	1.6,1.8,2.0,GL,GLS,GLI		E	'E 'H	CJ1011
Rod/Strut, stabiliser	1.6,1.8,2.0,GL,GLS,GLI	Rear		Z 'E 'H	CTR3107
Tie Rod End	1.6,1.8,2.0,GL,GLS,GLI		E	'E 'H	CTR5474
Rod/Strut, stabiliser	1.6,1.8,2.0,GL,GLS,GLI	Front	E	'E 'H	CTR6032

ELANTRA J3

01/2000 → 12/2006

Ball Joint	1.6,1.8,2.0,GL,GLS,GLI		E	'E 'H	CJ1011
Rod/Strut, stabiliser	1.6,1.8,2.0,GL,GLS,GLI	Rear		Z 'E 'H	CTR3107
Tie Rod End	1.6,1.8,2.0,GL,GLS,GLI		E	'E 'H	CTR5474
Rod/Strut, stabiliser	1.6,1.8,2.0,GL,GLS,GLI	Front	E	'E 'H	CTR6032

ELANTRA J4

01/2006 →

Ball Joint	1.6,2.0,GLS		E	'E 'H	CJ1011
Tie Rod End	1.6,2.0,GLS		E	'E 'H	CTR5474

GETZ

01/2003 → 12/2007

Ball Joint	1.3,1.4I,1.6 HS,CRDI		E	'E 'H	CJ1011
Tie Rod End	1.3,1.4I,1.6 HS,CRDI		E	'E 'H	CTR5474
Rod/Strut, stabiliser	1.3,1.4I,1.6 HS,CRDI		E	'E	CTR5915L
Rod/Strut, stabiliser	1.3,1.4I,1.6 HS,CRDI		E	'H	CTR5915R

GETZ

01/2007 →

Ball Joint	1.4 GL,HS,1.5 CRDI,HS,1.6 GL,GLS,HS		E	'E 'H	CJ1011
Tie Rod End	1.4 GL,HS,1.5 CRDI,HS,1.6 GL,GLS,HS		E	'E 'H	CTR5474
Rod/Strut, stabiliser	1.4 GL,HS,1.5 CRDI,HS,1.6 GL,GLS,HS		E	'E	CTR5915L
Rod/Strut, stabiliser	1.4 GL,HS,1.5 CRDI,HS,1.6 GL,GLS,HS		E	'H	CTR5915R

I10

01/2009 →

Rack End	1.1 GLS,1.2 GLS,HS		E	'E 'H	RE6055
----------	--------------------	--	---	-------	--------

I20

01/2009 →

Ball Joint	1.4,1.6		E	'E 'H	CJ1011
------------	---------	--	---	-------	--------

SANTA FE

01/2001 → 12/2006

Tie Rod End	2.4,2.7		E	'E 'H	CTR5567
-------------	---------	--	---	-------	---------

SONATA

01/1994 → 12/1999

Tie Rod End	2.0 GL,GLS,3.0GLS		E	'E 'H	CTR5567
-------------	-------------------	--	---	-------	---------

TIBURON

01/1996 → 12/1999

Ball Joint	2.0 FX		E	'E 'H	CJ1011
Tie Rod End	2.0 FX		E	'E 'H	CTR5474

						
CJ1011	CTR3107	CTR5474	CTR5567	CTR5915L	CTR5915R	CTR6032
Ref.Nr.: 5450322A00	Ref.Nr.: 5553029500AS	Ref.Nr.: 5682037010	Ref.Nr.: 568203B000	Ref.Nr.: 548301C000	Ref.Nr.: 548401C000	Ref.Nr.: 5483029000
						
RE6055						
Ref.Nr.: 577240X000						

HYUNDAI

Article Description			Fitting Position	Article No.
---------------------	---	---	------------------	-------------

TIBURON

01/2000 →

Ball Joint	2.0 GL,CRDI,2.7 V6		E	'E	'H	CJ1011	
Rod/Strut, stabiliser	2.0 GL,CRDI,2.7 V6	Rear		Z	'E	'H	CTR3107
Tie Rod End	2.0 GL,CRDI,2.7 V6		E	'E	'H	CTR5474	
Rod/Strut, stabiliser	2.0 GL,CRDI,2.7 V6	Front	E	'E	'H	CTR6032	

TUSCON

01/2004 → 12/2010

Control Arm-/Trailing Arm Bush	2.0 GL,CRDI,2.7 V6		E	'E	'H	BS7860
--------------------------------	--------------------	--	---	----	----	--------

HYUNDAI

					
BS7860	CJ1011	CTR3107	CTR5474	CTR6032	
Ref.Nr.: 545842E000	Ref.Nr.: 5450322A00	Ref.Nr.: 5553029500AS	Ref.Nr.: 5682037010	Ref.Nr.: 5483029000	

Article Description			Fitting Position	Article No.
---------------------	---	---	------------------	-------------

KB 01/1981 → 12/2004

Ball Joint	1.6,1.8,2.0,2.2,2.3,2.5	Upper	E	'E 'H	CJ930
------------	-------------------------	-------	---	-------	-------

KB FLEETSIDE,LE,LX,2X4 01/1989 → 12/2004

Ball Joint	160,200,220,230,250D,260,280,300	Upper	E	'E 'H	CJ930
Ball Joint	160,200,220,230,250D,260,280,300	Lower	E	'E 'H	CJ936
Ball Joint	160,200,220,230,250D,260,280,300	Lower KB320 Only	E	'E 'H	CJ946
Tie Rod End	160,200,220,230,250D,260,280,300	Inner	E	'E 'H	CTR5331L
Tie Rod End	160,200,220,230,250D,260,280,300	Outer	E	'E 'H	CTR5331R
Stabilizer Link	KB320	2002 >		'E	CTR6182L
Stabilizer Link	KB320	2002 >		'H	CTR6182R

KB FLEETSIDE,LE,LX,2X4 01/2004 →

Ball Joint	220,240I,250D,300TDI LE,LX	Upper Std Suspension	E	'E 'H	CJ1221
Ball Joint	220,240I,250D,300TDI LE,LX	Lower	E	'E 'H	CJ946
Tie Rod End	220,240I,250D,300TDI LE,LX		E	'E 'H	CTR5806
Stabilizer Link	220,240I,250D,300TDI LE,LX			'E	CTR6182L
Stabilizer Link	220,240I,250D,300TDI LE,LX			'H	CTR6182R

KB 4X4 01/1980 → 12/1989

Ball Joint	1.6,1.8,2.0,2.2,	Upper	E	'E 'H	CJ930
------------	------------------	-------	---	-------	-------

KB 4X4/HIGHRIDER 01/1989 → 12/2004

Ball Joint	220,230,250D,260,280DT,300TDI,320	Upper	E	'E 'H	CJ930
Ball Joint	220,230,250D,260,280DT,300TDI,320	Lower	E	'E 'H	CJ946
Tie Rod End	220,230,250D,260,280DT,300TDI,320	Inner	E	'E	CTR5331L
Tie Rod End	220,230,250D,260,280DT,300TDI,320	Outer	E	'H	CTR5331R
Stabilizer Link	220,230,250D,260,280DT,300TDI,320			'E	CTR6182L
Stabilizer Link	220,230,250D,260,280DT,300TDI,320			'H	CTR6182R

KB 4X4/HIGHRIDER 01/2004 →









Ball Joint	240I,250D,300TDI LE,LX,FLEETSIDE	Lower	E	'E 'H	CJ946
Tie Rod End	240I,250D,300TDI LE,LX,FLEETSIDE		E	'E 'H	CTR5806
Stabilizer Link	240I,250D,300TDI LE,LX,FLEETSIDE			'E	CTR6182L
Stabilizer Link	240I,250D,300TDI LE,LX,FLEETSIDE			'H	CTR6182R

FRONTIER 01/1998 → 12/2002

Ball Joint	280 LX	Upper	E	'E 'H	CJ930
Ball Joint	KB320	Lower KB320 Only	E	'E 'H	CJ946
Tie Rod End		Inner	E	'E 'H	CTR5331L
Tie Rod End	280 LX	Outer	E	'E 'H	CTR5331R

TROOPER 01/1987 → 12/1991

Ball Joint		Lower	E	'E 'H	CJ936
------------	--	-------	---	-------	-------

						
CJ1221	CJ930	CJ936	CJ946	CTR5331L	CTR5331R	CTR5806
Ref.Nr.: 898005827051	Ref.Nr.: 8944594534	Ref.Nr.: 8944594641	Ref.Nr.: 94452102	Ref.Nr.: 8944594812	Ref.Nr.: 8944194081	Ref.Nr.: 897304855051
						
CTR6182L	CTR6182R					
Ref.Nr.: 8979445690	Ref.Nr.: 8979445680					

ISUZU

Article Description			Fitting Position	Article No.
---------------------	---	---	------------------	-------------

SPORTAGE (JE_, KM_)

09/2004 →

Control Arm-/Trailing Arm Bush	2.016V 4WD, 2.0CRDi, 2.0CRDi 4WD, 2.0i 16V, 2.7V64W	Rubber-metal Bearing	E	'E 'H	BS7860
--------------------------------	---	----------------------	---	-------	--------

	
<p>BS7860</p>	
<p>Ref.Nr.: 545842E000</p>	

Article Description			Fitting Position	Article No.
---------------------	---	---	------------------	-------------

2 (DE) 10/2007 → 06/2015

Rod/Strut, stabiliser	1.3, 1.3 MZR, 1.4 MZR-CD, 1.5, 1.5 MZR, 1.6 MZ-CD	Material: Aluminium	E	'E 'H	CTR1418
Tie Rod Axle Joint	1.3, 1.3 MZR, 1.4 MZR-CD, 1.5, 1.5 MZR, 1.6 MZ-CD		E	'E 'H	RE6092

2 Saloon (DE) 05/2010 → 06/2015

Rod/Strut, stabiliser	1.5 i	Material: Aluminium	E	'E 'H	CTR1418
-----------------------	-------	---------------------	---	-------	---------

3 (BK) 10/2003 → 06/2009

Track Control Arm	1.4, 1.6, 1.6 DI Turbo, 2.0, 2.0 MZR-CD, 2.3 DiSi Turbo MPS, 2.3 MPS, 2.3 MZR, 2.3 MZR Sport	Material: Sheet Steel; with ball joint, with rubber mounting; with holder	E	'E	CJ294L
Track Control Arm	1.4, 1.6, 1.6 DI Turbo, 2.0, 2.0 MZR-CD, 2.3 DiSi Turbo MPS, 2.3 MPS, 2.3 MZR, 2.3 MZR Sport	Material: Sheet Steel; with ball joint, with rubber mounting; with holder	E	'H	CJ294R
Rod/Strut, stabiliser	1.4, 1.6, 1.6 DI Turbo, 2.0, 2.3 MZR Sport		E		CTR5923
Rod/Strut, stabiliser	1.4, 1.6 DI Turbo, 2.0, 2.0 MZR-CD		Z	'E 'H	CTR6191
Tie Rod Axle Joint	1.4, 1.6, 1.6 DI Turbo, 2.0, 2.3 DiSi Turbo MPS, 2.3 MPS, 2.3 MZR, 2.3 MZR Sport		E	'E 'H	RE5946

3 Saloon (BK) 06/2000 → 06/2009

Track Control Arm	1.6, 1.6 DI Turbo, 2.0, 2.0 MZR-CD, 2.3	Material: Sheet Steel; with ball joint, with rubber mounting; with holder	E	'E	CJ294L
Track Control Arm	1.6, 1.6 DI Turbo, 2.0, 2.0 MZR-CD, 2.3	Material: Sheet Steel; with ball joint, with rubber mounting; with holder	E	'H	CJ294R
Rod/Strut, stabiliser	1.6, 1.6 DI Turbo, 2.0		E		CTR5923
Rod/Strut, stabiliser	1.6, 1.6 DI Turbo, 2.0, 2.0 MZR-CD		Z	'E 'H	CTR6191
Tie Rod Axle Joint	1.6, 1.6 DI Turbo, 2.0		E	'E 'H	RE5946

323 01/1981 → 12/1986

Ball Joint	1.3 HATCHBACK, SEDAN 1.5 HATCHBACK, SEDAN		E	'E 'H	CJ926
Tie Rod Axle Joint	1.3 HATCHBACK, SEDAN 1.5 HATCHBACK, SEDAN	M/S	E	'E 'H	RE014

323/STING/MIDGE 01/1984 → 12/1997











Ball Joint	1.3, 1.5, 1.6, 160I, 2.0, 200I HATCH, SEDAN, L, SLX, EGI		E	'E 'H	CJ926
Tie Rod End	1.3, 1.5, 1.6, 160I, 2.0, 200I HATCH, SEDAN, L, SLX, EGI		E	'E 'H	CTR5184
Tie Rod Axle Joint	1.3, 1.5, 1.6, 160I, 2.0, 200I HATCH, SEDAN, L, SLX, EGI	M/S	E	'E 'H	RE014

5 (CR19) 02/2005 →

Track Control Arm	1.8, 2.0, 2.0 CD, 2.3	Material: Sheet Steel; with ball joint, with rubber mounting; with holder	E	'E	CJ294L
Track Control Arm	1.8, 2.0, 2.0 CD, 2.3	Material: Sheet Steel; with ball joint, with rubber mounting; with holder	E	'H	CJ294R
Rod/Strut, stabiliser	1.8, 2.0, 2.0 CD		E		CTR5923
Rod/Strut, stabiliser	1.8, 2.0, 2.0 CD		Z	'E 'H	CTR6191
Tie Rod Axle Joint	1.8, 2.0, 2.0 CD		E	'E 'H	RE5946

5 (CW) 09/2010 →

Track Control Arm	1.6 CD, 2.0	Material: Sheet Steel; with ball joint, with rubber mounting; with holder	E	'E	CJ294L
Track Control Arm	1.6 CD, 2.0	Material: Sheet Steel; with ball joint, with rubber mounting; with holder	E	'H	CJ294R

						
CJ294L	CJ294R	CJ926	CTR1418	CTR5184	CTR5923	CTR6191
Ref.Nr.: CC3034350C	Ref.Nr.: BP4K34300C	Ref.Nr.: B00134550	Ref.Nr.: 8V513B438AB	Ref.Nr.: 8AB032280	Ref.Nr.: 3M513B438AB	Ref.Nr.: 1310333
						
RE014	RE5946	RE6092				
Ref.Nr.: BF673224X	Ref.Nr.: BP4L32240	Ref.Nr.: 8V513L519AA				

MAZDA

Article Description			Fitting Position	Article No.
---------------------	---	---	------------------	-------------

6 (GG)

06/2002 → 08/2007

Track Control Arm	1.8, 2.0, 2.0 DI, 2.3	Material: Steel	E	'E	'H	CJ1199
Tie Rod Axle Joint	1.8, 2.0, 2.0 DI, 2.3		E	'E	'H	RE5948

6 Hatchback (GG)

08/2002 → 08/2007

Track Control Arm	1.8, 2.0, 2.0 DI, 2.3	Material: Steel	E	'E	'H	CJ1199
-------------------	-----------------------	-----------------	---	----	----	--------

6 Station Wagon (GY)

08/2002 → 08/2007

Track Control Arm	1.8, 2.0, 2.0 DI, 2.3, 2.3 AWD	Material: Steel	E	'E	'H	CJ1199
-------------------	--------------------------------	-----------------	---	----	----	--------

121/SOHO

01/1997 → 12/1999

Ball Joint	1.3,1.4		E	'E	'H	CJ582
------------	---------	--	---	----	----	-------

B-SERIE/MAGNUM

01/1986 → 12/1999

Ball Joint	B1600,B1800,B200,B2200,B2500,B2600,B3000,B3400	Upper	E	'E	'H	CJ918
Ball Joint	B1600,B1800,B200,B2200,B2500,B2600,B3000,B3400	Lower	E	'E	'H	CJ919
Tie Rod End	B1600,B1800,B200,B2200,B2500,B2600,B3000,B3400	Inner	E	'E	'H	CTR5338
Tie Rod End	B1600,B1800,B200,B2200,B2500,B2600,B3000,B3400	Outer	E	'E	'H	CTR5339

BT-50

01/2007 → 12/2014

Ball Joint	2.5TDI2.6,3.0CRDI,FREESTYLE,SLX,S/CAB,D/CAB	Lower	E	'E	'H	CJ1205
Ball Joint	2.5TDI2.6,3.0CRDI,FREESTYLE,SLX,S/CAB,D/CAB	Upper	E	'E	'H	CJ918
Tie Rod End	2.5TDI2.6,3.0CRDI,FREESTYLE,SLX,S/CAB,D/CAB	Inner	E	'E	'H	CTR5984

DRIFTER 2X4 STD

01/2000 → 12/2007

Ball Joint	2.5TDI,2.6,3.0CRDI,FREESTYLE,SLX,S/CAB,D/CAB	Upper	E	'E	'H	CJ918
Ball Joint	2.5TDI,2.6,3.0CRDI,FREESTYLE,SLX,S/CAB,D/CAB	Lower	E	'E	'H	CJ919
Tie Rod End	2.5TDI,2.6,3.0CRDI,FREESTYLE,SLX,S/CAB,D/CAB	Inner	E	'E	'H	CTR5338
Tie Rod End	2.5TDI,2.6,3.0CRDI,FREESTYLE,SLX,S/CAB,D/CAB	Outer	E	'E	'H	CTR5339

DRIFTER 4X4/Hi-TRAIL

01/2000 → 12/2007

Ball Joint	2.5TDI2.6,3.0CRDI,FREESTYLE,SLX,S/CAB,D/CAB	Upper	E	'E	'H	CJ918
Ball Joint	2.5TDI2.6,3.0CRDI,FREESTYLE,SLX,S/CAB,D/CAB	Hi Trail Lower	E	'E	'H	CJ983
Tie Rod End	2.5TDI2.6,3.0CRDI,FREESTYLE,SLX,S/CAB,D/CAB	Hi Trail Inner Alt	E	'E	'H	CTR5308
Tie Rod End	2.5TDI2.6,3.0CRDI,FREESTYLE,SLX,S/CAB,D/CAB	Inner	E	'E	'H	CTR5308
Tie Rod End	2.5TDI2.6,3.0CRDI,FREESTYLE,SLX,S/CAB,D/CAB	Outer	E	'E	'H	CTR5335

MAZDA

						
CJ1199	CJ1205	CJ582	CJ918	CJ919	CJ983	CTR5308
Ref.Nr.: GJ6A34300B	Ref.Nr.: UR6134550	Ref.Nr.: 7152281	Ref.Nr.:	Ref.Nr.: K9597	Ref.Nr.: 8AU334510	Ref.Nr.: 6M343280AA
						
CTR5335	CTR5338	CTR5339	CTR5984	RE5948		
Ref.Nr.: XM343289BA	Ref.Nr.:	Ref.Nr.:	Ref.Nr.: UR5632250	Ref.Nr.: GJ6A32240		

Article Description			Fitting Position	Article No.
---------------------	---	---	------------------	-------------

MIDGE/STING

01/1991 → 12/2004

Ball Joint	130,160,200I,HATCH,SEDAN		E	'E	'H	CJ926
Tie Rod End	130,160,200I,HATCH,SEDAN		E	'E	'H	CTR5184
Tie Rod Axle Joint	130,160,200I,HATCH,SEDAN	M/S	E	'E	'H	RE014

MX-3 (EC)

07/1991 → 10/1997

Tie Rod End	1.6 i, 1.8 i V6		E	'E	'H	CTR5184
-------------	-----------------	--	---	----	----	---------

RUSTLER

01/1985 → 12/1986

Track Control Arm	1.3,1.4,1.6		E		'H	CJ843
Track Control Arm	1.3,1.4,1.6		E	'E		CJ844
Track Control Arm	1.3,1.4,1.6		E		'H	CJ964
Track Control Arm	1.3,1.4,1.6		E	'E		CJ965
Tie Rod End	130,160,160I		E	'E	'H	CTR5184
Tie Rod Axle Joint	130,160,160I	M&S	E	'E	'H	RE014

RX 7 Mk III (FD)

07/1992 → 08/2002

Tie Rod End	Wankel Twin Turbo		E	'E	'H	CTR5184
-------------	-------------------	--	---	----	----	---------

						
CJ843	CJ844	CJ926	CJ964	CJ965	CTR5184	RE014
Ref.Nr.: 3246130	Ref.Nr.: 5021457	Ref.Nr.: B00134550	Ref.Nr.: 1637182	Ref.Nr.: 1637185	Ref.Nr.: 8AB032280	Ref.Nr.: BF673224X

MERCEDES-BENZ

Article Description			Fitting Position	Article No.
---------------------	---	---	------------------	-------------

A-CLASS (W169)

09/2004 → 06/2012

Ball Joint	A 150, A 160, A 160 CDI, A 170, A 180, A 180 CDI, A 200, A 200 CDI, A 200 TURBO, E-CELL	Number of mounting bores: 3; with fastening material	E	'E	'H	CJ1143
------------	---	--	---	----	----	--------

B-CLASS (W245)

03/2005 → 11/2011

Ball Joint	B 150, B 160, B 170, B 170 NGT, B 180, B 180 CDI, B 180 NGT, B 200, B 200 CDI, B 200 TURBO	Number of mounting bores: 3; with fastening material	E	'E	'H	CJ1143
------------	--	--	---	----	----	--------

C-CLASS (W202)

03/1993 → 05/2000

Ball Joint	C 180, C 200, C 200 CDI, C 200 D, C 200 Kompressor, C 220, C 220 CDI, C 220 D, C 230, C 230 Kompressor, C 240, C 250 D, C 250 Turbo-D, C 280, C 36 AMG, C 43		E	'E	'H	CJ1028
Tie Rod End	C 180, C 200, C 200 CDI, C 200 D, C 200 Kompressor, C 220, C 220 CDI, C 220 D, C 230, C 230 Kompressor, C 240, C 250 D, C 250 Turbo-D, C 280, C 36 AMG, C 43		E	'E	'H	CTR5497

C-CLASS Estate (S202)

06/1996 → 03/2001











Ball Joint	C 180 T, C 200 T, C 200 T CDI, C 200 T D, C 200 T Kompressor, C 220 T CDI, C 220 T D, C 230 T, C 230 T Kompressor, C 240 T, C 250 T Turbo-D, C 280 T, C 43 AMG		E	'E	'H	CJ1028
Tie Rod End	C 180 T, C 200 T, C 200 T CDI, C 200 T D, C 200 T Kompressor, C 220 T CDI, C 220 T D, C 230 T, C 230 T Kompressor, C 250 T Turbo-D		E	'E	'H	CTR5497
Tie Rod Axle Joint	C 200 T Kompressor		E	'E	'H	RE5782

C-CLASS (W203)

05/2000 → 02/2007

Track Control Arm	C 180, C 180 Kompressor, C 200 CDI, C 200 CGI Kompressor, C 200 Kompressor, C 220 CDI, C 230, C 230 Kompressor, C 240, C 270 CDI, C 280, C 30 CDI AMG, C 32 AMG Kompressor, C 320, C 320 CDI, C 350, C 55 AMG		E	'E		CJ996L
Track Control Arm	C 180, C 180 Kompressor, C 200 CDI, C 200 CGI Kompressor, C 200 Kompressor, C 220 CDI, C 230, C 230 Kompressor, C 240, C 270 CDI, C 280, C 30 CDI AMG, C 32 AMG Kompressor, C 320, C 320 CDI, C 350, C 55 AMG		E		'H	CJ996R
Track Control Arm	C 180, C 180 Kompressor, C 200 CDI, C 200 CGI Kompressor, C 200 Kompressor, C 220 CDI, C 230, C 230 Kompressor, C 240, C 240 4-matic, C 270 CDI, C 280, C 30 CDI AMG, C 32 AMG Kompressor, C 320, C 320 4-matic, C 320 CDI, C 350, C 55 AMG	Material: Aluminium	E	'E		CJ997L
Track Control Arm	C 180, C 180 Kompressor, C 200 CDI, C 200 CGI Kompressor, C 200 Kompressor, C 220 CDI, C 230, C 230 Kompressor, C 240, C 240 4-matic, C 270 CDI, C 280, C 30 CDI AMG, C 32 AMG Kompressor, C 320, C 320 4-matic, C 320 CDI, C 350, C 55 AMG	Material: Aluminium	E		'H	CJ997R
Tie Rod End	C 180, C 180 Kompressor, C 200 CDI, C 200 CGI Kompressor, C 200 Kompressor, C 220 CDI, C 230, C 230 Kompressor, C 240, C 270 CDI, C 280, C 30 CDI AMG, C 32 AMG Kompressor, C 320, C 320 CDI, C 350, C 55 AMG		E	'E		CTR5781L
Rod/Strut, stabiliser	C 180, C 180 Kompressor, C 200 CDI, C 200 CGI Kompressor, C 200 Kompressor, C 220 CDI, C 230, C 230 Kompressor, C 240, C 240 4-matic, C 270 CDI, C 280, C 320, C 320 4-matic, C 320 CDI, C 350	Material: Steel; for vehicles with standard chassis	E	'E	'H	CTR5783
Rod/Strut, stabiliser	C 180, C 180 Kompressor, C 200 CDI, C 200 CGI Kompressor, C 200 Kompressor, C 220 CDI, C 230 Kompressor, C 240, C 240 4-matic, C 270 CDI, C 30 CDI AMG, C 320, C 320 4-matic, C 350 AMG	ch.→A666024, E019386, F593966, R156265; Material: Steel; not for model year: 2005; for vehicles with sports suspension	E	'E	'H	CTR5783

MERCEDDES-BENZ

						
CJ1028	CJ1143	CJ996L	CJ996R	CJ997L	CJ997R	CTR5497
Ref.Nr.: 2103330427	Ref.Nr.: 1693330127	Ref.Nr.: 2033301911	Ref.Nr.: 2043302011	Ref.Nr.: 2033300111	Ref.Nr.: 2033303611	Ref.Nr.: 0013307435
						
CTR5781L	CTR5783	RE5782				
Ref.Nr.: 2033303903	Ref.Nr.: 2033302589	Ref.Nr.: 2203380715				

MERCEDES-BENZ

Article Description			Fitting Position	Article No.
---------------------	---	---	------------------	-------------

C-CLASS (W203)

05/2000 → 02/2007

Tie Rod Axle Joint	C 180 , C 180 Kompressor , C 200 CDI , C 200 CGI Kompressor , C 200 Kompressor , C 220 CDI , C 230 Kompressor , C240 , C270 CDI , C32 AMG Kompressor , C 320		E	'E	H	RE5782
--------------------	--	--	---	----	---	--------

C-CLASS Coupe (CL203)

03/2001 → 05/2008

Track Control Arm	C 160 Kompressor , C 180 , C 180 Kompressor , C 200 CDI , C 200 CGI Kompressor , C 200 Kompressor , C 220 CDI , C 230 , C 230 Kompressor , C 30 CDI AMG , C 32 AMG Kompressor , C 320 , C 350		E	'E		CJ996L
Track Control Arm	C 160 Kompressor , C 180 , C 180 Kompressor , C 200 CDI , C 200 CGI Kompressor , C 200 Kompressor , C 220 CDI , C 230 , C 230 Kompressor , C 30 CDI AMG , C 32 AMG Kompressor , C 320 , C 350		E		H	CJ996R
Track Control Arm	C 160 Kompressor , C 180 , C 180 Kompressor , C 200 CDI , C 200 CGI Kompressor , C 200 Kompressor , C 220 , C 220 CDI , C 230 , C 230 Kompressor , C 30 CDI AMG , C 32 AMG Kompressor , C 320 , C 350	Material: Aluminium	E	'E		CJ997L
Track Control Arm	C 160 Kompressor , C 180 , C 180 Kompressor , C 200 CDI , C 200 CGI Kompressor , C 200 Kompressor , C 220 , C 220 CDI , C 230 , C 230 Kompressor , C 30 CDI AMG , C 32 AMG Kompressor , C 320 , C 350	Material: Aluminium	E		H	CJ997R
Tie Rod End	C 160 Kompressor , C 180 , C 180 Kompressor , C 200 CDI , C 200 CGI Kompressor , C 200 Kompressor , C 220 , C 220 CDI , C 230 , C 230 Kompressor , C 30 CDI AMG , C 32 AMG Kompressor , C 320 , C 350		E	'E		CTR5781L
Rod/Strut, stabiliser	C 160 Kompressor , C 180 , C 180 Kompressor , C 200 CDI , C 200 CGI Kompressor , C 200 Kompressor , C 220 CDI , C 230 , C 230 Kompressor , C 320 , C 350	Material: Steel; for vehicles with standard chassis	E	'E	H	CTR5783
Rod/Strut, stabiliser	C 180 , C 180 Kompressor , C 200 Kompressor , C 220 CDI , C 230 Kompressor , C 320	ch.→A436251; Material: Steel; for vehicles with sports suspension	E	'E	H	CTR5783
Tie Rod Axle Joint	C 160 Kompressor , C 180 , C 180 Kompressor , C 200 CDI , C 200 CGI Kompressor , C 200 Kompressor , C 220 , C 220 CDI , C 230 , C 230 Kompressor , C 30 CDI AMG , C 32 AMG Kompressor , C 320 , C 350		E	'E	H	RE5782

C-CLASS T-Model (S203)

03/2001 → 08/2007

Track Control Arm	C 180 , C 180 Kompressor , C 200 CDI , C 200 CGI Kompressor , C 200 Kompressor , C 220 CDI , C 230 , C 230 Kompressor , C 240 , C 270 CDI , C 280 , C 30 CDI AMG , C 32 AMG Kompressor , C 320 , C 320 CDI , C 350 , C 55 AMG		E	'E		CJ996L
Track Control Arm	C 180 , C 180 Kompressor , C 200 CDI , C 200 CGI Kompressor , C 200 Kompressor , C 220 CDI , C 230 , C 230 Kompressor , C 240 , C 270 CDI , C 280 , C 30 CDI AMG , C 32 AMG Kompressor , C 320 , C 320 CDI , C 350 , C 55 AMG		E		H	CJ996R
Track Control Arm	C 180 , C 180 Kompressor , C 200 CDI , C 200 CGI Kompressor , C 200 Kompressor , C 220 CDI , C 230 , C 230 Kompressor , C 240 , C 240 4-matic , C 270 CDI , C 280 , C 30 CDI AMG , C 32 AMG Kompressor , C 320 , C 320 4-matic , C 320 CDI , C 350 , C 55 AMG	Material: Aluminium	E	'E		CJ997L
Track Control Arm	C 180 , C 180 Kompressor , C 200 CDI , C 200 CGI Kompressor , C 200 Kompressor , C 220 CDI , C 230 , C 230 Kompressor , C 240 , C 240 4-matic , C 270 CDI , C 280 , C 30 CDI AMG , C 32 AMG Kompressor , C 320 , C 320 4-matic , C 320 CDI , C 350 , C 55 AMG	Material: Aluminium	E		H	CJ997R
Tie Rod End	C 180 , C 180 Kompressor , C 200 CDI , C 200 CGI Kompressor , C 200 Kompressor , C 220 CDI , C 230 , C 230 Kompressor , C 240 , C 270 CDI , C 280 , C 30 CDI AMG , C 32 AMG Kompressor , C 320 , C 320 CDI , C 350 , C 55 AMG		E	'E		CTR5781L

						
CJ996L	CJ996R	CJ997L	CJ997R	CTR5781L	CTR5783	RE5782
Ref.Nr.: 2033301911	Ref.Nr.: 2043302011	Ref.Nr.: 2033300111	Ref.Nr.: 2033303611	Ref.Nr.: 2033303903	Ref.Nr.: 2033202589	Ref.Nr.: 2203380715

MERCEDES-BENZ

MERCEDES-BENZ

Article Description			Fitting Position	Article No.
---------------------	---	---	------------------	-------------

C-CLASS T-Model (S203)

03/2001 → 08/2007

Rod/Strut, stabiliser	C 180 , C 180 Kompressor , C 200 CDI , C 200 CGI Kompressor , C 200 Kompressor , C 220 CDI , C 230 , C 230 Kompressor , C 240 , C 270 CDI , C 280 , C 320 , C 320 CDI , C 350	Material: Steel; for vehicles with standard chassis	E	'E	'H	CTR5783
Tie Rod Axle Joint	C 180 , C 180 Kompressor , C 200 CDI , C 200 CGI Kompressor , C 200 Kompressor , C 220 CDI , C 230 , C 230 Kompressor , C 240 , C 270 CDI , C 280 , C 30 CDI AMG , C 32 AMG Kompressor , C 320 , C 320 CDI , C 350 , C 55 AMG		E	'E	'H	RE5782

C-CLASS (W204)

01/2007 → 01/2014

Rod/Strut, stabiliser	C 180 CDI , C 180 CGI , C 180 Kompressor , C 200 CDI , C 200 CGI , C 200 Kompressor , C 220 CDI , C 230 , C 250 CDI , C 250 CGI , C 280 , C 300 , C 320 CDI , C 350 , C 350 CDI , C 350 CGI	for vehicles with active stabilizer; Material: Steel; for vehicles with sports suspension	E		'H	CTR6047R
Rod/Strut, stabiliser	C 63 AMG	Material: Steel	E		'H	CTR6047R

C-CLASS Coupe (C204)

06/2011 →

Rod/Strut, stabiliser	C 180 , C 220 CDI , C 250 , C 250 CDI , C 350	for vehicles with active stabilizer; Material: Steel; for vehicles with sports suspension	E		'H	CTR6047R
Rod/Strut, stabiliser	C 63 AMG	Material: Steel	E		'H	CTR6047R

C-CLASS T-Model (S204)

08/2007 → 08/2014

Rod/Strut, stabiliser	C 180 CDI , C 180 CGI , C 180 Kompressor , C 200 CDI , C 200 Kompressor , C 220 CDI , C 230 , C 250 CDI , C 250 CGI , C 280 , C 320 CDI , C 350 , C 350 CDI , C 350 CGI	for vehicles with active stabilizer; Material: Steel; for vehicles with sports suspension	E		'H	CTR6047R
Rod/Strut, stabiliser	C 63 AMG	Material: Steel	E		'H	CTR6047R
Tie Rod Axle Joint	C 180 Kompressor , C 200 CDI , C 230 , C 280 , C 320 CDI , C 350		E	'E	'H	RE5782

CLC-CLASS (CL203)

05/2008 → 06/2011

Track Control Arm	CLC 160 , CLC 180 Kompressor , CLC 200 CDI , CLC 200 Kompressor , CLC 220 CDI , CLC 230 , CLC 350	Material: Aluminium	E	'E		CJ997L
Track Control Arm	CLC 160 , CLC 180 Kompressor , CLC 200 CDI , CLC 200 Kompressor , CLC 220 CDI , CLC 230 , CLC 350	Material: Aluminium	E		'H	CJ997R
Tie Rod End	CLC 160 , CLC 180 Kompressor , CLC 200 CDI , CLC 200 Kompressor , CLC 220 CDI , CLC 230 , CLC 350		E	'E		CTR5781L
Rod/Strut, stabiliser	CLC 160 , CLC 180 Kompressor , CLC 200 CDI , CLC 200 Kompressor , CLC 220 CDI , CLC 230 , CLC 350	Material: Steel; for vehicles with standard chassis	E	'E	'H	CTR5783
Rod/Strut, stabiliser	CLC 180 Kompressor	ch.→A436251; Material: Steel; for vehicles with sports suspension	E	'E	'H	CTR5783

CLK (C208)

06/1997 → 07/2002

Ball Joint	200, 200 Kompressor , 230 Kompressor , 320, 430, 5.4, 55 AMG		E	'E	'H	CJ1028
Tie Rod End	200, 200 Kompressor , 230 Kompressor , 320, 430, 55 AMG		E	'E	'H	CTR5497

CLK Convertible (A208)









03/1998 → 03/2002

Ball Joint	200, 200 Kompressor , 230 Kompressor , 320, 430, 55 AMG		E	'E	'H	CJ1028
Tie Rod End	200, 200 Kompressor , 230 Kompressor , 320, 430, 55 AMG		E	'E	'H	CTR5497

CLK (C209)

06/2002 → 05/2009

Track Control Arm	200 CGI , 200 Kompressor , 220 CDI , 240, 270 CDI , 280, 320, 320 CDI , 350, 500, 55 AMG , 63 AMG , CLK DTM AMG		E	'E		CJ996L
-------------------	---	--	---	----	--	--------

						
CJ1028	CJ996L	CJ997L	CJ997R	CTR5497	CTR5781L	CTR5783
Ref.Nr.: 2103330427	Ref.Nr.: 2033301911	Ref.Nr.: 2033300111	Ref.Nr.: 2033303611	Ref.Nr.: 0013307435	Ref.Nr.: 2033303903	Ref.Nr.: 2033202589
						
CTR6047R	RE5782					
Ref.Nr.: 2043201889	Ref.Nr.: 2203380715					

MERCEDES-BENZ

Article Description			Fitting Position	Article No.
---------------------	---	---	------------------	-------------

CLK (C209)

06/2002 → 05/2009

Track Control Arm	200CGI , 200 Kompressor, 220CDI, 240, 270CDI, 280, 320, 320 CDI, 350, 500, 55 AMG, 63 AMG, CLK DTM AMG		E		H	CJ996R
Track Control Arm	200CGI , 200 Kompressor, 220CDI, 240, 270CDI, 280, 320, 320 CDI, 350, 500, 55 AMG, 63 AMG	Material: Aluminium	E	E		CJ997L
Track Control Arm	200CGI , 200 Kompressor, 220CDI, 240, 270CDI, 280, 320, 320 CDI, 350, 500, 55 AMG, 63 AMG	Material: Aluminium	E		H	CJ997R
Tie Rod End	200CGI , 200 Kompressor, 220CDI, 240, 270CDI, 280, 320, 320 CDI, 350, 500, 55 AMG, 63 AMG, CLK DTM AMG		E	E		CTR5781L
Rod/Strut, stabiliser	200CGI , 200 Kompressor, 220CDI, 240, 270CDI, 280, 320, 320 CDI, 350, 500	Material: Steel; for vehicles with standard chassis	E	E	H	CTR5783

CLK Convertible (A209)

02/2003 → 03/2010

Track Control Arm	CLK 200 Kompressor, CLK 240, CLK 280, CLK 320, CLK 320 CDI, CLK 350, CLK 500, CLK 55 AMG, CLK 63 AMG		E	E		CJ996L
Track Control Arm	CLK 200 Kompressor, CLK 240, CLK 280, CLK 320, CLK 320 CDI, CLK 350, CLK 500, CLK 55 AMG, CLK 63 AMG		E		H	CJ996R
Track Control Arm	CLK 200CGI, CLK 200 Kompressor, CLK 240, CLK 280, CLK 320, CLK 320 CDI, CLK 350, CLK 500, CLK 55 AMG	Material: Aluminium	E	E		CJ997L
Track Control Arm	CLK 200CGI, CLK 200 Kompressor, CLK 240, CLK 280, CLK 320, CLK 320 CDI, CLK 350, CLK 500, CLK 55 AMG	Material: Aluminium	E		H	CJ997R
Tie Rod End	CLK 200 CGI, CLK 200 Kompressor, CLK 240, CLK 280, CLK 320, CLK 320 CDI, CLK 350, CLK 500, CLK 55 AMG, CLK 63 AMG, CLK AMG DTM		E	E		CTR5781L
Rod/Strut, stabiliser	CLK 200 Kompressor, CLK 240, CLK 280, CLK 320, CLK 320 CDI, CLK 350, CLK 500	Material: Steel; for vehicles with standard chassis	E	E	H	CTR5783

CLS (C219)

10/2004 → 02/2011

Ball Joint	CLS 280, CLS 300, CLS 320 CDI, CLS 350, CLS 350 CDI, CLS 350 CGI, CLS 500, CLS 55 AMG, CLS 550, CLS 63 AMG		E	E	H	CJ1193
------------	--	--	---	---	---	--------

COUPE (C123)

03/1977 → 12/1985

Tie Rod End	230 C, 230 CE, 280 C, 280 CE		E	E	H	CTR5172
-------------	------------------------------	--	---	---	---	---------

E-CLASS (W210)











06/1995 → 03/2002

Ball Joint	E 200, E 200 CDI, E 200 D, E 200 Kompressor, E 220 CDI, E 220 D, E 230, E 240, E 250 D, E 250 Turbo-D, E 270 CDI, E 280, E 280 4-matic, E 290 Turbo-D, E 300 D, E 300 Turbo-D, E 320, E 320 4-matic, E 320 CDI, E 36 AMG, E 420, E 430, E		E	E	H	CJ1028
Tie Rod Axle Joint	E 200, E 200 CDI, E 200 D, E 200 Kompressor, E 220 CDI, E 220 D, E 230, E 240, E 250 D, E 250 Turbo-D, E 280, E 290 Turbo-D, E 300 D, E 300 Turbo-D, E 320, E 420, E 430, E 50 AMG, E 55 AMG		E	E	H	RE5444

E-CLASS Estate (S210)

06/1996 → 03/2003

Ball Joint	E 200 T, E 200 T Kompressor, E 220 T CDI, E 230 T, E 240 T, E 250 TD, E 250 T Turbo-D, E 270 T CDI, E 280 T, E 280 T 4-matic, E 290 T Turbo-D, E 300 T Turbo-D, E 320 T, E 320 T 4-matic, E 320 T CDI, E 420 T, E 430 T, E 430 T 4-matic, E		E	E	H	CJ1028
Tie Rod Axle Joint	E 200 T, E 200 T Kompressor, E 220 T CDI, E 230 T, E 240 T, E 250 TD, E 250 T Turbo-D, E 280 T, E 280 T 4-matic, E 290 T Turbo-D, E 300 T Turbo-D, E 320 T, E 420 T, E 430 T, E 55 T AMG		E	E	H	RE5444

						
CJ1028	CJ1193	CJ996L	CJ996R	CJ997L	CJ997R	CTR5172
Ref.Nr.: 2103330427	Ref.Nr.: 2203330127	Ref.Nr.: 2033301911	Ref.Nr.: 2043302011	Ref.Nr.: 2033300111	Ref.Nr.: 2033303611	Ref.Nr.: 1233380210
						
CTR5781L	CTR5783	RE5444				
Ref.Nr.: 2033303903	Ref.Nr.: 2033202589	Ref.Nr.: 2103380415				

MERCEDES-BENZ

Article Description			Fitting Position	Article No.
---------------------	---	---	------------------	-------------

E-CLASS (W211)

03/2002 → 12/2008

Ball Joint	3.5 4-matic, E 240 4-matic, E 280 4-matic, E 280 CDI 4-matic, E 320 4-matic, E 320 CDI 4-matic, E 350 4-matic, E 500 4-matic		E	'E	'H	CJ1028
Ball Joint	E 200 CDI, E 200 CGI, E 200 Kompressor, E 220 CDI, E 230, E 240, E 240 4-matic, E 270 CDI, E 280, E 280 CDI, E 300 BlueTEC, E 320, E 320 4-matic, E 320 CDI, E 350, E 350 CGI, E 400 CDI, E 420 CDI, E 500, E 500 4-matic, E 55 AMG Kompresso		E	'E	'H	CJ1193
Tie Rod Axle Joint	E 200 CDI, E 200 CGI, E 200 Kompressor, E 220 CDI, E 240, E 240 4-matic, E 270 CDI, E 280, E 280 4-matic, E 280 CDI, E 280 CDI 4-matic, E 320, E 320 4-matic, E 320 CDI, E 320 CDI 4-matic, E 350, E 350 4-matic, E 400 CDI, E 420 CDI, E 500,		E	'E	'H	RE5782

E-CLASS T-Model (S211)

03/2003 → 07/2009

Ball Joint	E 240 T 4-matic, E 280 T 4-matic, E 280 T CDI 4-matic, E 320 T 4-matic, E 320 T CDI 4-matic, E 350 T 4-matic, E 500 T 4-matic		E	'E	'H	CJ1028
Ball Joint	350 CGI, E 200 CDI, E 200 Kompressor, E 200 T Kompressor, E 220 CDI, E 220 T CDI, E 230 T, E 240 T, E 240 T 4-matic, E 270 T CDI, E 280 T, E 280 T CDI, E 320 T, E 320 T 4-matic, E 320 T CDI, E 350 T, E 500 T, E 500 T 4-matic, E 55 T AMG K		E	'E	'H	CJ1193

E-CLASS Convertible (A207)

01/2010 →

Rod/Strut, stabiliser	E 200 CGI, E 220 CDI, E 250 CDI, E 250 CGI, E 300, E 350, E 350 CDI, E 350 CGI, E 500, E 550 CGI	for vehicles with active stabilizer; Material: Steel; for vehicles with sports suspension	E		'H	CTR6047R
-----------------------	--	---	---	--	----	----------

E-CLASS Coupe (C207)

01/2009 →

Rod/Strut, stabiliser	E 200 CGI, E 220 CDI, E 250 CDI, E 250 CGI, E 300, E 350, E 350 CDI, E 350 CGI, E 500, E 550 CGI	for vehicles with active stabilizer; Material: Steel; for vehicles with sports suspension	E		'H	CTR6047R
-----------------------	--	---	---	--	----	----------

Saloon (W123)

01/1976 → 12/1985

Tie Rod End	200, 200 D, 220 D, 230, 230 E, 240 D, 250, 280, 280 E, 300 D		E	'E	'H	CTR5172
-------------	--	--	---	----	----	---------

S-CLASS (W220)

10/1998 → 08/2005

Ball Joint	S 350 4-matic, S 430 4-matic, S 500 4-matic		E	'E	'H	CJ1028
Ball Joint	S 280, S 320, S 320 CDI, S 350, S 350 4-matic, S 400 CDI, S 430, S 430 4-matic, S 500, S 500 4-matic, S 55 AMG, S 55 AMG Kompressor, S 600, S 63 AMG, S 65 AMG		E	'E	'H	CJ1193
Tie Rod Axle Joint	S 280, S 320, S 320 CDI, S 350, S 350 4-matic, S 400 CDI, S 430, S 430 4-matic, S 500, S 500 4-matic, S 55 AMG, S 55 AMG Kompressor, S 600, S 63 AMG, S 65 AMG		E	'E	'H	RE5782

S-CLASS Coupe (C215)

03/1999 → 03/2006

Ball Joint	CL 500, CL 55 AMG, CL 55 AMG Kompressor, CL 600, CL 63 AMG, CL 65 AMG		E	'E	'H	CJ1193
Tie Rod Axle Joint	CL 500, CL 55 AMG, CL 63 AMG		E	'E	'H	RE5782

S-CLASS (W221)

12/2005 → 12/2013

Tie Rod Axle Joint	S 600		E	'E	'H	RE5782
--------------------	-------	--	---	----	----	--------

SL (R230)

10/2001 → 01/2012











Ball Joint	280, 300, 350, 500, 55 AMG, 55 AMG Kompressor, 600, 63 AMG, 65 AMG		E	'E	'H	CJ1193
------------	--	--	---	----	----	--------

				
CJ1028	CJ1193	CTR5172	CTR6047R	RE5782
Ref.Nr.: 2103330427	Ref.Nr.: 2203330127	Ref.Nr.: 1233380210	Ref.Nr.: 2043201889	Ref.Nr.: 2203380715

MERCEDES-BENZ

Article Description			Fitting Position	Article No.
SL (R230) 10/2001 → 01/2012				
Tie Rod Axle Joint	500, 55 AMG		E 'E 'H	RE5782
SLK (R170) 09/1996 → 04/2004				
Ball Joint	200, 200 Kompressor , 230 Kompressor , 32 AMG Kompressor , 320		E 'E 'H	CJ1028
Tie Rod End	32 AMG Kompressor , 320		E 'E 'H	CTR5497
SLK (R171) 03/2004 → 02/2011				
Track Control Arm	200 Kompressor , 280, 350, 55 AMG		E 'E	CJ996L
Track Control Arm	200 Kompressor , 280, 350, 55 AMG		E 'H	CJ996R
Track Control Arm	200 Kompressor , 280, 300, 350	Material: Aluminium	E 'E	CJ997L
Track Control Arm	200 Kompressor , 280, 300, 350	Material: Aluminium	E 'H	CJ997R
Tie Rod End	200 Kompressor , 280, 300, 350, 55 AMG		E 'E	CTR5781L
SPRINTER 2-t Bus (901, 902) 02/1995 → 05/2006				
Tie Rod End	208CDI, 208D, 210D, 211 CDI, 212D, 213 CDI, 214, 214 NGT, 216 CDI		E 'E 'H	CTR5542
SPRINTER 2-t Box (901, 902) 02/1995 → 05/2006				
Tie Rod End	208CDI, 208D, 210D, 211 CDI, 212D, 213 CDI, 214, 214 NGT, 216 CDI		E 'E 'H	CTR5542
SPRINTER 2-t Platform/Chassis (901, 902) 01/1995 → 05/2006				
Tie Rod End	208CDI, 208D, 210D, 211 CDI, 212D, 213 CDI, 214, 214 NGT, 216 CDI		E 'E 'H	CTR5542
SPRINTER 3-t Bus (903) 02/1995 → 05/2006				
Tie Rod End	2.9TDI, 308 CDI, 308D, 308E, 310D 4x4, 311 CDI, 311 CDI 4x4, 312 D 2.9, 312 D 2.9 4x4, 313 CDI, 313 CDI 4x4, 314, 314 4x4, 314 NGT, 316 CDI, 316 CDI 4x4		E 'E 'H	CTR5542
SPRINTER 3-t Box (903) 02/1995 → 05/2006				
Tie Rod End	308CDI, 308D 2.3, 310D 2.9, 311 CDI, 311 CDI 4x4, 312D 2.9, 312D 2.9 4x4, 313 CDI, 313 CDI 4x4, 314, 314 4x4, 314 NGT, 316 CDI, 316 CDI 4x4		E 'E 'H	CTR5542
SPRINTER 3-t Platform/Chassis (903) 02/1995 → 05/2006				
Tie Rod End	308CDI, 308D 2.3, 310D 2.9, 311 CDI, 311 CDI 4x4, 312D 2.9, 313 CDI, 313 CDI 4x4, 314, 314 4x4, 314 NGT, 316 CDI, 316 CDI 4x4		E 'E 'H	CTR5542
SPRINTER 3-t Bus (906) 06/2006 →				
Tie Rod End	210CDI, 211 CDI, 213 CDI, 215 CDI, 216, 216 CDI, 224		E 'E 'H	CTR5927
Tie Rod Axle Joint	210CDI, 211 CDI, 213 CDI, 215 CDI, 216, 216 CDI, 224		E 'E 'H	RE5928
SPRINTER 3-t Box (906) 06/2006 →				
Tie Rod End	209 CDI, 210 CDI, 211 CDI, 213 CDI, 215 CDI, 216, 216 CDI, 218 CDI, 219 CDI, 224		E 'E 'H	CTR5927
Tie Rod Axle Joint	209 CDI, 210 CDI, 211 CDI, 213 CDI, 215 CDI, 216, 216 CDI, 218 CDI, 219 CDI, 224		E 'E 'H	RE5928

MERCEDES-BENZ

						
CJ1028	CJ996L	CJ996R	CJ997L	CJ997R	CTR5497	CTR5542
Ref.Nr.: 2103330427	Ref.Nr.: 2033301911	Ref.Nr.: 2043302011	Ref.Nr.: 2033300111	Ref.Nr.: 2033303611	Ref.Nr.: 0013307435	Ref.Nr.: 2D0422811
						
CTR5781L	CTR5927	RE5782	RE5928			
Ref.Nr.: 2033303903	Ref.Nr.: 90610481003	Ref.Nr.: 2203380715	Ref.Nr.: 90610551003			

MERCEDES-BENZ

Article Description			Fitting Position	Article No.
---------------------	---	---	------------------	-------------

SPRINTER 3-t Platform/Chassis (906)

06/2006 →

Tie Rod End	209 CDI, 210 CDI, 211 CDI, 213 CDI, 215 CDI, 216, 216 CDI, 218 CDI, 219 CDI, 224		E	'E	'H	CTR5927
Tie Rod Axle Joint	209 CDI, 210 CDI, 211 CDI, 213 CDI, 215 CDI, 216, 216 CDI, 218 CDI, 219 CDI, 224		E	'E	'H	RE5928

SPRINTER 3,5-t Bus (906)

06/2006 →

Tie Rod End	310 CDI, 311 CDI, 311 CDI 4x4, 313 CDI, 313 CDI 4x4, 315 CDI, 315 CDI 4x4, 316, 316 CDI, 316 CDI 4x4, 316 LGT, 316 NGT, 318 CDI, 318 CDI 4x4, 319 CDI, 319 CDI 4x4, 324		E	'E	'H	CTR5927
Tie Rod Axle Joint	310 CDI, 311 CDI, 311 CDI 4x4, 313 CDI, 313 CDI 4x4, 315 CDI, 315 CDI 4x4, 316, 316 CDI, 316 CDI 4x4, 316 LGT, 316 NGT, 318 CDI, 318 CDI 4x4, 319 CDI, 319 CDI 4x4, 324		E	'E	'H	RE5928

SPRINTER 3,5-t Box (906)

06/2006 →

Tie Rod End	309 CDI, 310 CDI, 311 CDI, 311 CDI 4x4, 313 CDI, 313 CDI 4x4, 315 CDI, 315 CDI 4x4, 316, 316 CDI, 316 CDI 4x4, 316 LGT, 316 NGT, 318 CDI, 318 CDI 4x4, 319 CDI, 319 CDI 4x4, 324		E	'E	'H	CTR5927
Tie Rod Axle Joint	309 CDI, 310 CDI, 311 CDI, 311 CDI 4x4, 313 CDI, 313 CDI 4x4, 315 CDI, 315 CDI 4x4, 316, 316 CDI, 316 CDI 4x4, 316 LGT, 316 NGT, 318 CDI, 318 CDI 4x4, 319 CDI, 319 CDI 4x4, 324		E	'E	'H	RE5928

SPRINTER 3,5-t Platform/Chassis (906)

06/2006 →

Tie Rod End	309 CDI, 310 CDI, 311 CDI, 311 CDI 4x4, 313 CDI, 313 CDI 4x4, 315 CDI, 315 CDI 4x4, 316, 316 CDI, 316 CDI 4x4, 316 LGT, 316 NGT, 318 CDI, 318 CDI 4x4, 319 CDI, 319 CDI 4x4, 324		E	'E	'H	CTR5927
Tie Rod Axle Joint	309 CDI, 310 CDI, 311 CDI, 311 CDI 4x4, 313 CDI, 313 CDI 4x4, 315 CDI, 315 CDI 4x4, 316, 316 CDI, 316 CDI 4x4, 316 LGT, 316 NGT, 318 CDI, 318 CDI 4x4, 319 CDI, 319 CDI 4x4, 324		E	'E	'H	RE5928

SPRINTER 4-t Bus (904)

02/1996 → 05/2006

Tie Rod End	408 CDI, 411 CDI, 413 CDI, 414, 416 CDI		E	'E	'H	CTR5542
-------------	---	--	---	----	----	---------

SPRINTER 4-t Box (904)

02/1996 → 05/2006

Tie Rod End	408 CDI, 408 D, 410 D, 410 D 4x4, 411 CDI, 411 CDI 4x4, 412 D, 412 D 4x4, 413 CDI, 413 CDI 4x4, 414, 414 4x4, 416 CDI, 416 CDI 4x4		E	'E	'H	CTR5542
-------------	--	--	---	----	----	---------

SPRINTER 4-t Platform/Chassis (904)

02/1996 → 05/2006



Tie Rod End	408 CDI, 408 D, 410 D, 410 D 4x4, 411 CDI, 411 CDI 4x4, 412 D, 412 D 4x4, 413 CDI, 413 CDI 4x4, 414, 414 4x4, 416 CDI, 416 CDI 4x4		E	'E	'H	CTR5542
-------------	--	--	---	----	----	---------

SPRINTER 4,6-t Box (906)

06/2006 →

Tie Rod End	411 CDI, 413 CDI, 415 CDI, 416 CDI, 418 CDI, 419 CDI, 42		E	'E	'H	CTR5927
Tie Rod Axle Joint	411 CDI, 413 CDI, 415 CDI, 416 CDI, 418 CDI, 419 CDI, 42		E	'E	'H	RE5928

MERCEDDES-BENZ

		
CTR5542	CTR5927	RE5928
Ref.Nr.: 2D0422811	Ref.Nr.: 90610481003	Ref.Nr.: 90610551003

Article Description			Fitting Position	Article No.
---------------------	---	---	------------------	-------------

SPRINTER 4,6-t Platform/Chassis (906)

06/2006 →

Tie Rod End	411 CDI, 413 CDI, 415 CDI, 416 CDI, 418 CDI, 419 CDI, 424		E	'E	'H	CTR5927
Tie Rod Axle Joint	411 CDI, 413 CDI, 415 CDI, 416 CDI, 418 CDI, 419 CDI, 424		E	'E	'H	RE5928

SPRINTER 5-t Box (906)

06/2006 →

Tie Rod End	509 CDI, 510 CDI, 511 CDI, 511 CDI 4x4, 513 CDI, 513 CDI 4x4, 515 CDI, 515 CDI 4x4, 516 CDI, 516 CDI 4x4, 518 CDI, 518 CDI 4x4, 519 CDI, 519 CDI 4x4, 524		E	'E	'H	CTR5927
Tie Rod Axle Joint	509 CDI, 510 CDI, 511 CDI, 511 CDI 4x4, 513 CDI, 513 CDI 4x4, 515 CDI, 515 CDI 4x4, 516 CDI, 516 CDI 4x4, 518 CDI, 518 CDI 4x4, 519 CDI, 519 CDI 4x4, 524		E	'E	'H	RE5928

SPRINTER 5-t Platform/Chassis (906)

06/2006 →

Tie Rod End	509 CDI, 510 CDI, 511 CDI, 511 CDI 4x4, 513 CDI, 513 CDI 4x4, 515 CDI, 515 CDI 4x4, 516, 516 CDI, 516 CDI 4x4, 516NGT, 518 CDI, 518 CDI 4x4, 519 CDI, 519 CDI 4x4, 524		E	'E	'H	CTR5927
Tie Rod Axle Joint	509 CDI, 510 CDI, 511 CDI, 511 CDI 4x4, 513 CDI, 513 CDI 4x4, 515 CDI, 515 CDI 4x4, 516, 516 CDI, 516 CDI 4x4, 516NGT, 518 CDI, 518 CDI 4x4, 519 CDI, 519 CDI 4x4, 524		E	'E	'H	RE5928

	
CTR5927	RE5928
Ref.Nr.: 90610481003	Ref.Nr.: 90610551003

Article Description			Fitting Position	Article No.
---------------------	---	---	------------------	-------------

MINI (R56)

03/2008 → 11/2013

Rod/Strut, stabiliser	John Cooper Works	Equipment Variant: C-CUP, CHALLENGE	E	E	H	CTR5380
-----------------------	-------------------	-------------------------------------	----------	----------	----------	----------------

	
CTR5380	
Ref.Nr.: 31351124380	

Article Description			Fitting Position	Article No.
---------------------	---	---	------------------	-------------

CHALLENGER I (K90)

11/1998 → 10/2003

Ball Joint	2.5 TD , 3.0 V6		E	'E	'H	CJ904
Ball Joint	2.5 TD , 3.0 V6		E	'E		CJ961L
Ball Joint	2.5 TD , 3.0 V6		E		'H	CJ961R
Tie Rod End	2.5 TD , 2.8 TDi, 3.0 V6		E	'E	'H	CTR5556
Tie Rod End	2.5 TD , 3.0 V6		E	'E	'H	CTR5557

COLT HIGH LINE RODEO 2X4

01/1998 → 12/2009

Ball Joint	2.0,2.4,2.5,2.8D,2.8TDI	Upper	E	'E	'H	CJ904
Ball Joint	2.0,2.4,2.5,2.8D,2.8TDI	Hi-Rider Lower	E	'E		CJ961L
Ball Joint	2.0,2.4,2.5,2.8D,2.8TDI	Hi-Rider Lower	E		'H	CJ961R
Tie Rod End	2.0,2.4,2.5,2.8D,2.8TDI	Hi Rider Inner	E	'E	'H	CTR5556
Tie Rod End	2.0,2.4,2.5,2.8D,2.8TDI	Hi-Rider Outer	E	'E	'H	CTR5557

COLT HIGH LINE RODEO 4X4

01/1998 → 12/2009

Ball Joint	2.0,2.4,2.5,2.8D,2.8TDI	Upper	E	'E	'H	CJ904
Ball Joint	2.0,2.4,2.5,2.8D,2.8TDI	Hi-Rider Lower	E	'E		CJ961L
Ball Joint	2.0,2.4,2.5,2.8D,2.8TDI	Hi-Rider Lower	E		'H	CJ961R
Tie Rod End	2.0,2.4,2.5,2.8D,2.8TDI	Hi Rider Inner	E	'E	'H	CTR5556
Tie Rod End	2.0,2.4,2.5,2.8D,2.8TDI	Hi-Rider Outer	E	'E	'H	CTR5557

PAJERO/SHOGUN (L04_G, L14_G)

11/1988 → 12/1991

Ball Joint	2.5 TD		E		'H	CJ961R
Tie Rod End	2.5 TD , 3.0 V6	01/1990 →	E	'E	'H	CTR5556
Tie Rod End	2.5 TD , 3.0 V6	01/1990 →	E	'E	'H	CTR5557

PAJERO/SHOGUN (L04_G, L14_G)

11/1988 → 12/1991

Ball Joint	2.5 TD		E	'E		CJ961L
------------	--------	--	---	----	--	--------

PAJERO/SHOGUN Mk II Open Off-Road Vehicle (L04_G)





01/1983 → 11/1990

Ball Joint	2.5 TD		E	'E		CJ961L
Ball Joint	2.5 TD		E		'H	CJ961R
Tie Rod End	2.5 TD , 2.6	01/1990 →	E	'E	'H	CTR5556
Tie Rod End	2.5 TD , 2.6	01/1990 →	E	'E	'H	CTR5557



PAJERO/SHOGUN Mk II (V3_W, V2_W, V4_W)

12/1990 → 10/1999

Ball Joint	2.5TD4x4, 2.8TD, 3.0V624V, 3.0V64x4, 3.5V624V		E	'E	'H	CJ904
Ball Joint	2.4, 2.5TD4x4, 2.8TD, 3.0V624V, 3.0V64x4, 3.5V624V	for OE: MB831037	E	'E		CJ961L
Ball Joint	2.4, 2.5TD4x4, 2.8TD, 3.0V624V, 3.0V64x4, 3.5V624V	for OE: MB831038	E		'H	CJ961R
Tie Rod End	2.4, 2.5TD4x4, 2.8TD, 3.0V624V, 3.0V64x4, 3.5V624V		E	'E	'H	CTR5556
Tie Rod End	2.4, 2.5TD4x4, 2.8TD, 3.0V624V, 3.0V64x4, 3.5V624V		E	'E	'H	CTR5557

				
CJ904	CJ961L	CJ961R	CTR5556	CTR5557
Ref.Nr.: MB860830	Ref.Nr.: MR296269	Ref.Nr.: MR296270	Ref.Nr.: MB831044	Ref.Nr.: MB831043

mitsubishi

Article Description			Fitting Position	Article No.
PAJERO/SHOGUN Mk II Open Off-Road Vehicle (V2_W, V4_W)			12/1990 → 04/2000	
Tie Rod End	1.8 GDI, 2.4 , 2.5 TD , 3.0 V6 , 3.0 V6 24V		E	'E 'H CTR5556
Tie Rod End	1.8 GDI, 2.4 , 2.5 TD , 3.0 V6 , 3.0 V6 24V		E	'E 'H CTR5557
PAJERO/SHOGUN Mk II Open Off-Road Vehicle (V2_W, V4_W)			12/1990 → 04/2000	
Ball Joint	2.5 TD , 3.0 V6 , 3.0 V6 24V		E	'E 'H CJ904
Ball Joint	1.8 GDI, 2.4 , 2.5 TD , 3.0 V6 , 3.0 V6 24V	for OE: MB831037	E	'E CJ961L
PAJERO/SHOGUN Mk II Open Off-Road Vehicle (V2_W, V4_W)			12/1990 → 04/2000	
Ball Joint	1.8 GDI, 2.4 , 2.5 TD , 3.0 V6 , 3.0 V6 24V	for OE: MB831038	E	'H CJ961R
PAJERO/SHOGUN Mk III Open Off-Road Vehicle (V6_W, V7_W)			04/2000 → 12/2006	
Ball Joint	2.5 TDi		E	'E 'H CJ904
Ball Joint	2.5 TDi		E	'E CJ961L
Ball Joint	2.5 TDi		E	'H CJ961R
TRITON 2X4/4X4			01/2007 →	
Ball Joint	2.4MPI,2.5DI-D,3.5	Upper	E	'E 'H CJ904
Ball Joint	2.4MPI,2.5DI-D,3.5	Lower Left	E	'E CJ961L
Ball Joint	2.4MPI,2.5DI-D,3.5	Lower Right	E	'H CJ961R

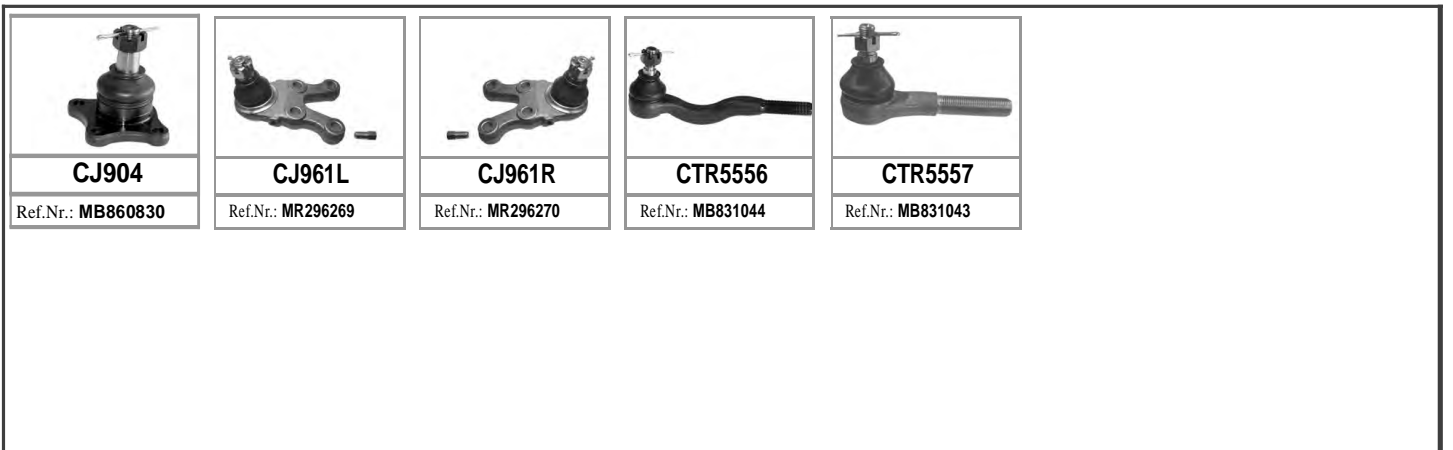

Article Description			Fitting Position	Article No.
---------------------	---	---	------------------	-------------

1 TONNER/HARDBODY 2X4

01/1988 → 12/1998

Ball Joint	1.6,1.8,2.0,2.5,2.7	2X4 Lower	E	'E 'H	CJ912
Tie Rod End	1.6,1.8,2.0,2.5,2.7	Outer	E	'E 'H	CTR5309
Tie Rod End	1.6,1.8,2.0,2.5,2.7	Inner	E	'E 'H	CTR5310

120Y,140Y SEDAN

01/1975 → 12/1980

Tie Rod End	1200,1400	Inner	E	'E	CTR1366L
Tie Rod End	1200,1400	Inner	E	'H	CTR1366R
Tie Rod End	1200,1400	Outer	E	'E	CTR1367L
Tie Rod End	1200,1400	Outer	E	'H	CTR1367R

300 ZX (Z31)

01/1984 → 10/1990

Rod/Strut, stabiliser	3.0, 3.0 Turbo		E	'E 'H	CTR5559
-----------------------	----------------	--	---	-------	---------

720

01/1980 → 12/1988

Tie Rod End	1.8 TRACKER	Outer	E	'E 'H	CTR5309
-------------	-------------	-------	---	-------	---------

1400 CHAMP PICKUP

01/1980 → 12/2008









Ball Joint	1200,1400		E	'E 'H	CJ787
Tie Rod End	1200,1400	Inner		'E	CTR1366L
Tie Rod End	1200,1400	Inner		'H	CTR1366R
Tie Rod End	1200,1400	Outer	E	'E	CTR1367L
Tie Rod End	1200,1400	Outer	E	'H	CTR1367R

						
CJ787	CJ912	CTR1367L	CTR1367R	CTR5309	CTR5310	CTR5559
Ref.Nr.: 40160B1001	Ref.Nr.: 4016001G00	Ref.Nr.: 48640H1001	Ref.Nr.: 48520H1001	Ref.Nr.: 4852131G25	Ref.Nr.: 4852101G25	Ref.Nr.: 54618D5000

NISSAN

Article Description			Fitting Position	Article No.
ALMERA Mk II (N16)				07/2000 →
Rod/Strut, stabiliser	1.5, 1.5 dCi, 1.8, 2.2 dCi, 2.2 Di	Material: Steel; with rubber mounting	E 'E 'H	CTR5682
ALMERA Mk II (N16)				01/2000 →
Rod/Strut, stabiliser	1.5, 1.5 dCi, 1.8, 2.2 dCi, 2.2 Di	Material: Steel; with rubber mounting	E 'E 'H	CTR5682
GRAND LIVINA				01/2008 →
Tie Rod Axle Joint	1.6 ACENTA, VISIA, X-GEAR		E 'E 'H	RE5990
GRAND LIVINA				01/2008 →
Track Control Arm	1.6 ACENTA, VISIA, X-GEAR		E ' 'H	CJ299R
GRAND LIVINA				01/2008 →
Track Control Arm	1.6 ACENTA, VISIA, X-GEAR		E 'E 'H	CJ299L
HARDBODY 2X4 QW/D22				01/1998 → 12/2001
Ball Joint	2.0,SL,2.4,SL,2.7,3.0,SL,3.2 SE	2X4 Upper	E 'E 'H	CJ877
Ball Joint	2.0,SL,2.4,SL,2.7,3.0,SL,3.2 SE	2X4 Lower	E 'E 'H	CJ912
Tie Rod End	2.0,SL,2.4,SL,2.7,3.0,SL,3.2 SE	Outer STD Body	E 'E 'H	CTR5600
Tie Rod End	2.0,SL,2.4,SL,2.7,3.0,SL,3.2 SE	2X4 Inner	E 'E 'H	CTR5601
HARDBODY 4X4 QW244/D22				01/1998 → 12/2010
Ball Joint	2.0,SL,2.4,SL,2.7,3.0,SL,3.2 SE	Upper	E 'E 'H	CJ877
Ball Joint	2.0,SL,2.4,SL,2.7,3.0,SL,3.2 SE	Lower	E 'E 'H	CJ912
Tie Rod End	2.0,SL,2.4,SL,2.7,3.0,SL,3.2 SE	Outer STD Body	E 'E 'H	CTR5600
Tie Rod End	2.0,SL,2.4,SL,2.7,3.0,SL,3.2 SE	Hi Rider 4X4 Inner	E 'E 'H	CTR5699
Tie Rod End	2.0,SL,2.4,SL,2.7,3.0,SL,3.2 SE	Hi Rider 4X4 Outer	E 'E 'H	CTR5700

NISSAN

						
CJ299L	CJ299R	CJ877	CJ912	CTR5601	CTR5682	CTR5699
Ref.Nr.: 8200744091	Ref.Nr.: 8200744092	Ref.Nr.:	Ref.Nr.: 4016001G00	Ref.Nr.: 485212S425	Ref.Nr.: 546184M400	Ref.Nr.: 485703S500
						
CTR5700	RE5990					
Ref.Nr.: 485200W025	Ref.Nr.: 485213U025					

Article Description			Fitting Position	Article No.
---------------------	---	---	------------------	-------------

HARDBODY D22 2X4

01/2008 →

Ball Joint	2.0 I SL 2,7D,3.0TD	Upper	E	'E	'H	CJ877
Ball Joint	2.0 I SL 2,7D,3.0TD	Lower	E	'E	'H	CJ912
Tie Rod End	2.0 I SL 2,7D,3.0TD	Outer STD Body	E	'E	'H	CTR5600
Tie Rod End	2.0 I SL 2,7D,3.0TD	Inner	E	'E	'H	CTR5601

HARDBODY D22 HI-RIDER/4X4

01/2008 →

Ball Joint	2.4I,2,7D,3.2 SL,3.3I	Lower	E	'E	'H	CJ912
Tie Rod End	2.4I,2,7D,3.2 SL,3.3I	Inner	E	'E	'H	CTR5699
Tie Rod End	2.4I,2,7D,3.2 SL,3.3I	Outer	E	'E	'H	CTR5700

HARDBODY D22 HI-RIDER/4X4

01/2008 →

Ball Joint	2.4I,2,7D,3.2 SL,3.3I	Upper	E	'E	'H	CJ877
------------	-----------------------	-------	---	----	----	-------

HARDBODY QW244/D22 2X4

01/2001 → 12/2008

Ball Joint	2.0 I SL 2,7D,3.0TD	Upper	E	'E	'H	CJ877
Tie Rod End	2.0 I SL 2,7D,3.0TD	Inner	E	'E	'H	CTR5601

HARDBODY QW244/D22 HI RIDER

01/2001 → 12/2008

Ball Joint	2.4I,2,7D,3.2 SL,3.3I	Upper	E	'E	'H	CJ877
Ball Joint	2.4I,2,7D,3.2 SL,3.3I	Lower	E	'E	'H	CJ912
Tie Rod End	2.4I,2,7D,3.2 SL,3.3I	Inner	E	'E	'H	CTR5699
Tie Rod End	2.4I,2,7D,3.2 SL,3.3I	Outer	E	'E	'H	CTR5700

				
CJ877	CJ912	CTR5601	CTR5699	CTR5700
Ref.Nr.:	Ref.Nr.: 4016001 G00	Ref.Nr.: 485212S425	Ref.Nr.: 485703S500	Ref.Nr.: 485200W025

Article Description			Fitting Position	Article No.
---------------------	---	---	------------------	-------------

HARDBODY/NP300 D25

01/2008 →

Ball Joint	2.4i,2.5TDI,S,SE	Upper	E	'E	'H	CJ877
Ball Joint	2.4i,2.5TDI,S,SE	Lower	E	'E	'H	CJ912
Tie Rod End	2.4i,2.5TDI,S,SE	Outer STD Body	E	'E	'H	CTR5600
Tie Rod End	2.4i,2.5TDI,S,SE	Inner	E	'E	'H	CTR5601
Tie Rod End	2.4i,2.5TDI,S,SE	Hi Rider 4X4 Inner	E	'E	'H	CTR5699
Tie Rod End	2.4i,2.5TDI,S,SE	Hi Rider 4X4 Outer	E	'E	'H	CTR5700

LIVINA

01/2008 →

Track Control Arm	1.6 ACENTA,VISIA,X-GEAR		E	'E		CJ299L
Track Control Arm	1.6 ACENTA,VISIA,X-GEAR		E		'H	CJ299R
Tie Rod Axle Joint	1.6 ACENTA,VISIA,X-GEAR		E	'E	'H	RE5990

MAXIMA III (J30)



10/1988 → 06/1994

Rod/Strut, stabiliser	3.0 i		E	'E	'H	CTR5559
-----------------------	-------	--	---	----	----	---------

MICRA

01/2005 → 12/2006

Control Arm-Trailing Arm Bush	1.4 COMFORT,ELEGANCE,SEACCENTA,VISIA1,5CDI		E	'E	'H	BS8147
Tie Rod End	1.4 COMFORT,ELEGANCE,SEACCENTA,VISIA1,5CDI		E	'E		CTR5726L
Tie Rod End	1.4 COMFORT,ELEGANCE,SEACCENTA,VISIA1,5CDI		E		'H	CTR5726R
Rod/Strut, stabiliser	1.4 COMFORT,ELEGANCE,SEACCENTA,VISIA1,5CDI		E	'E	'H	CTR5770

						
BS8147	CJ299L	CJ299R	CJ877	CJ912	CTR5559	CTR5601
Ref.Nr.: 54501BC41A	Ref.Nr.: 8200744091	Ref.Nr.: 8200744092	Ref.Nr.:	Ref.Nr.: 4016001G00	Ref.Nr.: 54618D5000	Ref.Nr.: 485212S425
						
CTR5699	CTR5700	CTR5726L	CTR5726R	CTR5770	RE5990	
Ref.Nr.: 485703S500	Ref.Nr.: 485200W025	Ref.Nr.: 7701476760	Ref.Nr.: 7701475843	Ref.Nr.: 8200127308	Ref.Nr.: 485213U025	

Article Description			Fitting Position	Article No.
---------------------	---	---	------------------	-------------

MICRA

01/2005 → 12/2006

Control Arm-/Trailing Arm Bush	1.4 COMFORT,ELEGANCE,SEACCENTA,VISIA1,5CDI		E	'E 'H	BS8218
--------------------------------	--	--	---	-------	--------

MICRA C+C

01/2005 → 12/2006

Control Arm-/Trailing Arm Bush	1.4 COMFORT,ELEGANCE,SEACCENTA,VISIA1,5CDI		E	'E 'H	BS8147
Control Arm-/Trailing Arm Bush	1.4 COMFORT,ELEGANCE,SEACCENTA,VISIA1,5CDI		E	'E 'H	BS8218
Tie Rod End	1.4 COMFORT,ELEGANCE,SEACCENTA,VISIA1,5CDI		E	'E	CTR5726L
Tie Rod End	1.4 COMFORT,ELEGANCE,SEACCENTA,VISIA1,5CDI		E	'H	CTR5726R
Rod/Strut, stabiliser	1.4 COMFORT,ELEGANCE,SEACCENTA,VISIA1,5CDI		E	'E 'H	CTR5770

NAVARA

01/2005 →

Rod/Strut, stabiliser	2.5DCI 4.0 V6		E	'E	CTR6150L
Rod/Strut, stabiliser	2.5DCI 4.0 V6		E	'H	CTR6150R

NP200

01/2008 →

Ball Joint	1.5DCI SE, 1.6 S,SE		E	'E 'H	CJ1145
Track Control Arm	1.5DCI SE, 1.6 S,SE		E	'E	CJ320L
Track Control Arm	1.5DCI SE, 1.6 S,SE		E	'H	CJ320R
Tie Rod End	1.5DCI SE, 1.6 S,SE		E	'E	CTR5985L
Tie Rod End	1.5DCI SE, 1.6 S,SE		E	'H	CTR5985R
Tie Rod Axle Joint	1.5DCI SE, 1.6 S,SE		E	'E 'H	RE5986

						
BS8147	BS8218	CJ1145	CJ320L	CJ320R	CTR5726L	CTR5726R
Ref.Nr.: 54501BC41A	Ref.Nr.: 54570AX600	Ref.Nr.: 8200679067	Ref.Nr.: 6001547520	Ref.Nr.: 6001547519	Ref.Nr.: 7701476760	Ref.Nr.: 7701475843
						
CTR5770	CTR5985L	CTR5985R	CTR6150L	RE5986		
Ref.Nr.: 8200127308	Ref.Nr.: 6001550442	Ref.Nr.: 6001547611	Ref.Nr.: 54668EA010	Ref.Nr.: 6001550441		

Article Description			Fitting Position	Article No.
---------------------	---	---	------------------	-------------

PATHFINDER

01/2005 →

Rod/Strut, stabiliser	2.5DCI 4.0 V6		E	'E		CTR6150L
Rod/Strut, stabiliser	2.5DCI 4.0 V6		E		'H	CTR6150R

PRIMERA

01/1998 → 12/2002

Rod/Strut, stabiliser	160SI,SE,200GSI,SI,STI,ELEGANCE,LUXURY		E	'E	'H	CTR5559
Tie Rod Axle Joint	160SI,SE,200GSI,SI,STI,ELEGANCE,LUXURY		E	'E	'H	RE053

SABRE

01/1994 → 12/2002

Rod/Strut, stabiliser	160SI,SE,200GSI,SI,STI		E	'E	'H	CTR5559
Tie Rod Axle Joint	160SI,SE,200GSI,SI,STI		E	'E	'H	RE053

SENTRA

01/1992 → 12/2002

Rod/Strut, stabiliser	160SI,SE,200GSI,SI,STI	P/S	E	'E	'H	CTR5559
Tie Rod Axle Joint	160SI,SE,200GSI,SI,STI	P/S	E	'E	'H	RE053

TIIDA HATCHBACK

01/2007 → 12/2011

Track Control Arm	1.6 ACENTA,VISIA,1.8 ACENTA		E	'E		CJ299L
Track Control Arm	1.6 ACENTA,VISIA,1.8 ACENTA		E		'H	CJ299R
Tie Rod Axle Joint	1.6 ACENTA,VISIA,1.8 ACENTA		E	'E	'H	RE5990

TIIDA SALOON

01/2007 → 12/2012

Track Control Arm	1.6 ACENTA,VISIA,1.8 ACENTA		E	'E		CJ299L
Track Control Arm	1.6 ACENTA,VISIA,1.8 ACENTA		E		'H	CJ299R

TIIDA SALOON

01/2007 → 12/2012

Tie Rod Axle Joint	1.6 ACENTA,VISIA,1.8 ACENTA		E	'E	'H	RE5990
--------------------	-----------------------------	--	---	----	----	--------

					
CJ299L	CJ299R	CTR5559	CTR6150L	RE053	RE5990
Ref.Nr.: 8200744091	Ref.Nr.: 8200744092	Ref.Nr.: 54618D5000	Ref.Nr.: 54668EA010	Ref.Nr.: 4852150Y00	Ref.Nr.: 485213U025

Article Description			Fitting Position	Article No.
---------------------	---	---	------------------	-------------

X-TRAIL (T30)

07/2001 → 01/2013

Rod/Strut, stabiliser	2.0, 2.0 4x4, 2.2 dCi, 2.2 dCi 4x4, 2.2 Di 4x4, 2.5 4x4		E		'E		CTR5675L
Rod/Strut, stabiliser	2.0, 2.0 4x4, 2.2 dCi, 2.2 dCi 4x4, 2.2 Di 4x4, 2.5 4x4		E			H	CTR5675R

	
<p>CTR5675L</p>	<p>CTR5675R</p>
<p>Ref.Nr.: 546688H300</p>	<p>Ref.Nr.: 546188H300</p>

Article Description			Fitting Position	Article No.
---------------------	---	---	------------------	-------------

ASCONA C (81_, 86_, 87_, 88_)

09/1981 → 08/1988

Ball Joint	1.3N, 1.3S, 1.6, 1.6D, 1.6i, 1.6i CAT, 1.6S, 1.8, 1.8E, 1.8 i, 2.0, 2.0i, 2.0i CAT, 2.0i GT	with add-on material	E	'E 'H	CJ951
------------	---	----------------------	---	-------	-------

ASCONA C Hatchback (84_, 89_)

09/1981 → 08/1988

Ball Joint	1.3N, 1.3S, 1.6, 1.6D, 1.6i, 1.6i CAT, 1.6S, 1.8, 1.8E, 1.8 i, 2.0i, 2.0i CAT, 2.0i GT	with add-on material	E	'E 'H	CJ951
------------	--	----------------------	---	-------	-------

ASTRA F (56_, 57_)

09/1991 → 09/1998

Control Arm-/Trailing Arm Bush	1.4i, 1.4i 16V, 1.4 Si, 1.6i, 1.6i 16V, 1.6 Si, 1.7 D, 1.7 TD, 1.7 TDS, 1.8 i, 1.8 i 16V, 2.0 i, 2.0 i 16V	ch.R2595226, R5111735, R6036588, R8145950, RB011798→	E	'E 'H	BS6383
Control Arm-/Trailing Arm Bush	1.4i, 1.4i 16V, 1.4 Si, 1.6i, 1.6i 16V, 1.6 Si, 1.7 D, 1.7 TD, 1.7 TDS, 1.8 i, 1.8 i 16V, 2.0 i, 2.0 i 16V	ch.→R2595225, R5111734, R6036587, R8145949, RB011797	E	'E 'H	BS6406
Track Control Arm	1.4 i, 1.4 Si, 1.6 i, 1.6 Si, 1.7 D	ch.→R2595225, R5111734, R8145949	E	'E	CJ1501L
Track Control Arm	1.4, 1.4 i 16V, 1.6, 1.6 i 16V, 1.8 i 16V		E	'E	CJ1501L
Track Control Arm	1.7 TD, 1.7 TDS, 1.8 i, 1.8 i 16V	ch.→R2588487, R5111734, R8145949	E	'E	CJ1501L
Track Control Arm	2.0 i	ch.→R2589925, R5111734, R8145949	E	'E	CJ1501L
Track Control Arm	2.0 i 16V	ch.→P2603822, P8146889	E	'E	CJ1501L
Track Control Arm	1.4 i, 1.4 Si, 1.6 i, 1.6 Si, 1.7 D	ch.→R2595225, R5111734, R8145949	E	'H	CJ1501R
Track Control Arm	1.4, 1.4 i 16V, 1.6, 1.6 i 16V, 1.8 i 16V		E	'H	CJ1501R
Track Control Arm	1.7 TD, 1.7 TDS, 1.8 i, 1.8 i 16V	ch.→R2588487, R5111734, R8145949	E	'H	CJ1501R
Track Control Arm	2.0 i	ch.→R2589925, R5111734, R8145949	E	'H	CJ1501R
Track Control Arm	2.0 i 16V	ch.→P2603822, P8146889	E	'H	CJ1501R
Ball Joint	1.4, 1.4i, 1.4i 16V, 1.4 Si, 1.6, 1.6i, 1.6i 16V, 1.6 Si, 1.7 D, 1.7 TD, 1.7 TDS, 1.8 i, 1.8 i 16V, 2.0 i, 2.0 i 16V	with add-on material	E	'E 'H	CJ951
Tie Rod End	1.4i, 1.4i 16V, 1.4 Si, 1.6i, 1.6i 16V, 1.6 Si, 1.7 D, 1.7 TD, 1.7 TDS, 1.8 i, 1.8 i 16V, 2.0 i, 2.0 i 16V	for OE: 324055	E	'E	CTR5427L
Tie Rod End	1.4i, 1.4i 16V, 1.4 Si, 1.6i, 1.6i 16V, 1.6 Si, 1.7 D, 1.7 TD, 1.7 TDS, 1.8 i, 1.8 i 16V, 2.0 i, 2.0 i 16V	for OE: 324056	E	'H	CTR5427R
Rod/Strut, stabiliser	1.4i, 1.4i 16V, 1.4 Si, 1.6i, 1.6i 16V, 1.6 Si, 1.7 D, 1.7 TD, 1.7 TDS, 1.8 i, 1.8 i 16V, 2.0 i, 2.0 i 16V	for OE: 350 263	E	'E 'H	CTR5643
Rod/Strut, stabiliser	1.4, 1.6	ch.R2595226, R5111735, R8145950, RB011798→; for OE: 350 263	E	'E 'H	CTR5643

ASTRA F Convertible (53_B)

03/1993 → 03/2001

Control Arm-/Trailing Arm Bush	1.4 i 16V, 1.4 Si, 1.6 i, 1.8 i 16V, 2.0 i	ch.R2595226, R5111735, R6036588, R8145950, RB011798→	E	'E 'H	BS6383
Control Arm-/Trailing Arm Bush	1.4 i 16V, 1.4 Si, 1.6 i, 1.8 i 16V, 2.0 i	ch.→R2595225, R5111734, R6036587, R8145949, RB011797	E	'E 'H	BS6406
Track Control Arm	1.4 i 16V, 1.6 i, 1.8 i 16V		E	'E	CJ1501L
Track Control Arm	1.4 Si, 1.6 i	ch.→R2595225, R5111734, R8145949	E	'E	CJ1501L
Track Control Arm	2.0 i	ch.→R2589925, R5111734, R8145949	E	'E	CJ1501L
Track Control Arm	1.4 i 16V, 1.6 i, 1.8 i 16V		E	'H	CJ1501R
Track Control Arm	1.4 Si, 1.6 i	ch.→R2595225, R5111734, R8145949	E	'H	CJ1501R
Track Control Arm	2.0 i	ch.→R2589925, R5111734, R8145949	E	'H	CJ1501R
Ball Joint	1.4 i 16V, 1.4 Si, 1.6 i, 1.8 i 16V, 2.0 i	with add-on material	E	'E 'H	CJ951
Tie Rod End	1.4 i 16V, 1.4 Si, 1.6 i, 1.8 i 16V, 2.0 i	for OE: 324055	E	'E	CTR5427L
Tie Rod End	1.4 i 16V, 1.4 Si, 1.6 i, 1.8 i 16V, 2.0 i	for OE: 324056	E	'H	CTR5427R
Rod/Strut, stabiliser	1.4 i 16V, 1.4 Si, 1.6 i, 1.8 i 16V, 2.0 i	for OE: 350 263	E	'E 'H	CTR5643

						
BS6383	BS6406	CJ1501L	CJ1501R	CJ951	CTR5427L	CTR5427R
Ref.Nr.: 90268463	Ref.Nr.: 90373778	Ref.Nr.: 0352077	Ref.Nr.: 0352192	Ref.Nr.: 1603163	Ref.Nr.: 90350447	Ref.Nr.: 0324054
						
CTR5643						
Ref.Nr.: 4400040						

Article Description			Fitting Position	Article No.
---------------------	---	---	------------------	-------------

ASTRA F Estate (51_, 52_)

09/1991 → 01/1998

Control Arm-/Trailing Arm Bush	1.4 i, 1.4 i 16V, 1.4 Si, 1.6 i, 1.6 i 16V, 1.6 Si, 1.7 D, 1.7 TD, 1.7 TDS, 1.8 i, 1.8 i 16V, 2.0 i, 2.0 i 16V	ch.R2595226, R5111735, R6036588, R8145950, RB011798→	E	'E 'H	BS6383
Control Arm-/Trailing Arm Bush	1.4 i, 1.4 i 16V, 1.4 Si, 1.6 i, 1.6 i 16V, 1.6 Si, 1.7 D, 1.7 TD, 1.7 TDS, 1.8 i, 1.8 i 16V, 2.0 i, 2.0 i 16V	ch.→R2595225, R5111734, R6036587, R8145949, RB011797	E	'E 'H	BS6406
Track Control Arm	1.4 i, 1.4 Si, 1.6 i, 1.6 Si	ch.→R2595225, R5111734, R8145949	E	'E	CJ1501L
Track Control Arm	1.4, 1.4 i 16V, 1.6, 1.6 i 16V, 1.8 i 16V		E	'E	CJ1501L
Track Control Arm	1.7 D, 1.7 TD, 1.7 TDS, 1.8 i, 1.8 i 16V	ch.→R2588487, R5111734, R8145949	E	'E	CJ1501L
Track Control Arm	2.0 i	ch.→R2589925, R5111734, R8145949	E	'E	CJ1501L
Track Control Arm	2.0 i 16V	ch.→P2603822, P8146889	E	'E	CJ1501L
Track Control Arm	1.4 i, 1.4 Si, 1.6 i, 1.6 Si	ch.→R2595225, R5111734, R8145949	E	'H	CJ1501R
Track Control Arm	1.4, 1.4 i 16V, 1.6, 1.6 i 16V, 1.8 i 16V		E	'H	CJ1501R
Track Control Arm	1.7 D, 1.7 TD, 1.7 TDS, 1.8 i, 1.8 i 16V	ch.→R2588487, R5111734, R8145949	E	'H	CJ1501R
Track Control Arm	2.0 i	ch.→R2589925, R5111734, R8145949	E	'H	CJ1501R
Track Control Arm	2.0 i 16V	ch.→P2603822, P8146889	E	'H	CJ1501R
Ball Joint	1.4, 1.4 i, 1.4 i 16V, 1.4 Si, 1.6, 1.6 i, 1.6 i 16V, 1.6 Si, 1.7 D, 1.7 TD, 1.7 TDS, 1.8 i, 1.8 i 16V, 2.0 i, 2.0 i 16V	with add-on material	E	'E 'H	CJ951
Tie Rod End	1.4 i, 1.4 i 16V, 1.4 Si, 1.6 i, 1.6 i 16V, 1.6 Si, 1.7 D, 1.7 TD, 1.7 TDS, 1.8 i, 1.8 i 16V, 2.0 i, 2.0 i 16V	for OE: 324055	E	'E	CTR5427L
Tie Rod End	1.4 i, 1.4 i 16V, 1.4 Si, 1.6 i, 1.6 i 16V, 1.6 Si, 1.7 D, 1.7 TD, 1.7 TDS, 1.8 i, 1.8 i 16V, 2.0 i, 2.0 i 16V	for OE: 324056	E	'H	CTR5427R
Rod/Strut, stabiliser	1.4	ch.R2595226, R5111735, R8145950, RB011798→; for OE: 350 263	E	'E 'H	CTR5643
Rod/Strut, stabiliser	1.4 i, 1.4 i 16V, 1.4 Si, 1.6, 1.6 i, 1.6 i 16V, 1.6 Si, 1.7 D, 1.7 TD, 1.7 TDS, 1.8 i, 1.8 i 16V, 2.0 i, 2.0 i 16V	for OE: 350 263	E	'E 'H	CTR5643

ASTRA F Hatchback (53_, 54_, 58_, 59_)

09/1991 → 01/1998

Control Arm-/Trailing Arm Bush	1.4 i, 1.4 i 16V, 1.4 Si, 1.6 i, 1.6 i 16V, 1.6 Si, 1.7 D, 1.7 TD, 1.7 TDS, 1.8 i, 1.8 i 16V, 2.0 GSI 16V, 2.0 i, 2.0 i 16V	ch.R2595226, R5111735, R6036588, R8145950, RB011798→	E	'E 'H	BS6383
Control Arm-/Trailing Arm Bush	1.4 i, 1.4 i 16V, 1.4 Si, 1.6 i, 1.6 i 16V, 1.6 Si, 1.7 D, 1.7 TD, 1.7 TDS, 1.8 i, 1.8 i 16V, 2.0 GSI 16V, 2.0 i, 2.0 i 16V	ch.→R2595225, R5111734, R6036587, R8145949, RB011797	E	'E 'H	BS6406
Track Control Arm	1.4 i, 1.4 Si, 1.6 i, 1.6 Si	ch.→R2595225, R5111734, R8145949	E	'E	CJ1501L
Track Control Arm	1.4, 1.4 i 16V, 1.6, 1.6 i 16V, 1.8 i 16V		E	'E	CJ1501L
Track Control Arm	1.7 D	ch.→R2591895, R5111734, R8145949	E	'E	CJ1501L
Track Control Arm	1.7 TD, 1.7 TDS, 1.8 i, 1.8 i 16V	ch.→R2588487, R5111734, R8145949	E	'E	CJ1501L
Track Control Arm	2.0 GSI 16V, 2.0 i 16V	ch.→P2603822, P8146889	E	'E	CJ1501L
Track Control Arm	2.0 i	ch.→R2589925, R5111734, R8145949	E	'E	CJ1501L
Track Control Arm	1.4 i, 1.4 Si, 1.6 i, 1.6 Si	ch.→R2595225, R5111734, R8145949	E	'H	CJ1501R
Track Control Arm	1.4, 1.4 i 16V, 1.6, 1.6 i 16V, 1.8 i 16V		E	'H	CJ1501R
Track Control Arm	1.7 D	ch.→R2591895, R5111734, R8145949	E	'H	CJ1501R
Track Control Arm	1.7 TD, 1.7 TDS, 1.8 i, 1.8 i 16V	ch.→R2588487, R5111734, R8145949	E	'H	CJ1501R
Track Control Arm	2.0 GSI 16V, 2.0 i 16V	ch.→P2603822, P8146889	E	'H	CJ1501R
Track Control Arm	2.0 i	ch.→R2589925, R5111734, R8145949	E	'H	CJ1501R
Ball Joint	1.4, 1.4 i, 1.4 i 16V, 1.4 Si, 1.6, 1.6 i, 1.6 i 16V, 1.6 Si, 1.7 D, 1.7 TD, 1.7 TDS, 1.8 i, 1.8 i 16V, 2.0 GSI 16V, 2.0 i, 2.0 i 16V	with add-on material	E	'E 'H	CJ951
Tie Rod End	1.4 i, 1.4 i 16V, 1.4 Si, 1.6 i, 1.6 i 16V, 1.6 Si, 1.7 D, 1.7 TD, 1.7 TDS, 1.8 i, 1.8 i 16V, 2.0 GSI 16V, 2.0 i, 2.0 i 16V	for OE: 324055	E	'E	CTR5427L
Tie Rod End	1.4 i, 1.4 i 16V, 1.4 Si, 1.6 i, 1.6 i 16V, 1.6 Si, 1.7 D, 1.7 TD, 1.7 TDS, 1.8 i, 1.8 i 16V, 2.0 GSI 16V, 2.0 i, 2.0 i 16V	for OE: 324056	E	'H	CTR5427R

						
BS6383	BS6406	CJ1501L	CJ1501R	CJ951	CTR5427L	CTR5427R
Ref.Nr.: 90268463	Ref.Nr.: 90373778	Ref.Nr.: 0352077	Ref.Nr.: 0352192	Ref.Nr.: 1603163	Ref.Nr.: 90350447	Ref.Nr.: 0324054
						
CTR5643						
Ref.Nr.: 4400040						

Article Description			Fitting Position	Article No.
---------------------	---	---	------------------	-------------

ASTRA F Hatchback (53_, 54_, 58_, 59_) 09/1991 → 01/1998

Rod/Strut, stabiliser	1.4 i, 1.4 i 16V, 1.4 Si, 1.6 i, 1.6 i 16V, 1.6 Si, 1.7 D, 1.7 TD, 1.7 TDS, 1.8 i, 1.8 i 16V, 2.0 GSI 16V, 2.0 i, 2.0 i 16V	for OE: 350 263	E	'E 'H	CTR5643
Rod/Strut, stabiliser	1.4, 1.6	ch.R2595226, R5111735, R8145950, RB011798→; for OE: 350 263	E	'E 'H	CTR5643

ASTRA F CLASSIC Estate 01/1998 → 01/2005

Control Arm-/Trailing Arm Bush	1.4 i, 1.6 i, 1.6 i 16V		E	'E 'H	BS6383
Control Arm-/Trailing Arm Bush	1.4 i, 1.6 i, 1.6 i 16V		E	'E 'H	BS6406
Track Control Arm	1.4 i, 1.6 i, 1.6 i 16V		E	'E	CJ1501L
Track Control Arm	1.4 i, 1.6 i, 1.6 i 16V		E	'H	CJ1501R
Ball Joint	1.4 Comfort, 1.4 i, 1.6 i, 1.6 i 16V, 1.8	with add-on material	E	'E 'H	CJ951
Rod/Strut, stabiliser	1.4 Comfort, 1.4 i, 1.6 i, 1.6 i 16V, 1.8	for OE: 350 263	E	'E 'H	CTR5643

ASTRA F CLASSIC Hatchback 01/1998 → 08/2002

Control Arm-/Trailing Arm Bush	1.4 i, 1.6 i, 1.6 i 16V		E	'E 'H	BS6383
Control Arm-/Trailing Arm Bush	1.4 i, 1.6 i, 1.6 i 16V		E	'E 'H	BS6406
Track Control Arm	1.4 i, 1.6 i, 1.6 i 16V		E	'E	CJ1501L
Track Control Arm	1.4 i, 1.6 i, 1.6 i 16V		E	'H	CJ1501R
Ball Joint	1.2 i, 1.4 i, 1.6 i, 1.6 i 16V, 1.7 TD, 1.8 i, 2.0 Di, 2.0 DTi, 2.0 i	with add-on material	E	'E 'H	CJ951
Rod/Strut, stabiliser	1.2 i, 1.4 i, 1.6 i, 1.6 i 16V, 1.7 TD, 1.8 i, 2.0 Di, 2.0 DTi, 2.0 i	for OE: 350 263	E	'E 'H	CTR5643

ASTRA F CLASSIC Saloon 01/1998 → 08/2002



Control Arm-/Trailing Arm Bush	1.4 i, 1.6 i, 1.6 i 16V		E	'E 'H	BS6383
Control Arm-/Trailing Arm Bush	1.4 i, 1.6 i, 1.6 i 16V		E	'E 'H	BS6406
Track Control Arm	1.4 i, 1.6 i, 1.6 i 16V		E	'E	CJ1501L
Track Control Arm	1.4 i, 1.6 i, 1.6 i 16V		E	'H	CJ1501R
Ball Joint	1.4 i, 1.6 i, 1.6 i 16V	with add-on material	E	'E 'H	CJ951
Rod/Strut, stabiliser	1.4 i, 1.6 i, 1.6 i 16V	for OE: 350 263	E	'E 'H	CTR5643

ASTRA F Van (55_) 10/1991 → 01/1999

Control Arm-/Trailing Arm Bush	1.4 i, 1.6 i, 1.7 D, 1.7 TD	ch.R2595226, R5111735, R6036588, R8145950, RB011798→	E	'E 'H	BS6383
Control Arm-/Trailing Arm Bush	1.4 i, 1.6 i, 1.7 D, 1.7 TD	ch.→R2595225, R5111734, R6036587, R8145949, RB011797	E	'E 'H	BS6406
Track Control Arm	1.4 i, 1.6 i, 1.7 D, 1.7 TD		E	'E	CJ1501L
Track Control Arm	1.4 i, 1.6 i, 1.7 D, 1.7 TD		E	'H	CJ1501R
Ball Joint	1.4 i, 1.6 i, 1.7 D, 1.7 TD	with add-on material	E	'E 'H	CJ951
Tie Rod End	1.4 i, 1.6 i, 1.7 D, 1.7 TD	for OE: 324055	E	'E	CTR5427L
Tie Rod End	1.4 i, 1.6 i, 1.7 D, 1.7 TD	for OE: 324056	E	'H	CTR5427R
Rod/Strut, stabiliser	1.4 i, 1.6 i, 1.7 D, 1.7 TD	for OE: 350 263	E	'E 'H	CTR5643

ASTRA G Convertible (F67) 03/2001 → 10/2005

Ball Joint	1.6, 1.6 16V, 1.8 16V, 2.0 16V Turbo, 2.0 OPC, 2.2 16V, 2.2 DTI	with add-on material	E	'E 'H	CJ1089
Rod/Strut, stabiliser	1.6, 1.6 16V, 1.8 16V, 2.0 16V Turbo, 2.0 OPC, 2.2 16V, 2.2 DTI	Alternative Repair Kit: G7-1517; Material: Plastic	E	'E 'H	CTR2462

						
BS6383	BS6406	CJ1089	CJ1501L	CJ1501R	CJ951	CTR2462
Ref.Nr.: 90268463	Ref.Nr.: 90373778	Ref.Nr.: 90542995	Ref.Nr.: 0352077	Ref.Nr.: 0352192	Ref.Nr.: 1603163	Ref.Nr.: 350614
						
CTR5427L	CTR5427R	CTR5643				
Ref.Nr.: 90350447	Ref.Nr.: 0324054	Ref.Nr.: 4400040				

Article Description			Fitting Position	Article No.
---------------------	---	---	------------------	-------------

ASTRA G Convertible (F67)

03/2001 → 10/2005

Tie Rod End	1.6, 1.6 16V, 1.8 16V, 2.0 16V Turbo, 2.0 OPC, 2.2 16V, 2.2 DTI		E	'E	'H	CTR5170
Top Strut Mounting	1.6, 1.6 16V, 1.8 16V, 2.0 16V Turbo, 2.0 OPC, 2.2 16V, 2.2 DTI	Soft Version; without ball bearing	E	'E	'H	MO6848

ASTRA G Estate (F35_)

02/1998 → 12/2009

Ball Joint	1.2 16V, 1.4, 1.4 16V, 1.6, 1.6 16V, 1.6 CNG, 1.7 CDTI, 1.7 DTI 16V, 1.7 TD, 1.8 16V, 2.0 16V, 2.0 DI, 2.0 DTI 16V, 2.0 OPC, 2.2 16V, 2.2 DTI	with add-on material	E	'E	'H	CJ1089
Rod/Strut, stabiliser	1.2 16V, 1.4, 1.4 16V, 1.6, 1.6 16V, 1.6 CNG, 1.7 CDTI, 1.7 DTI 16V, 1.7 TD, 1.8 16V, 2.0 16V, 2.0 DI, 2.0 DTI 16V, 2.0 OPC, 2.2 16V, 2.2 DTI	Alternative Repair Kit: G7-1517; Material: Plastic	E	'E	'H	CTR2462
Tie Rod End	1.2 16V, 1.4, 1.4 16V, 1.6, 1.6 16V, 1.6 CNG, 1.7 CDTI, 1.7 DTI 16V, 1.7 TD, 1.8 16V, 2.0 16V, 2.0 DI, 2.0 DTI 16V, 2.0 OPC, 2.2 16V, 2.2 DTI		E	'E	'H	CTR5170
Top Strut Mounting	1.2 16V, 1.4 16V, 1.6, 1.6 16V, 1.6 CNG, 1.7 CDTI, 1.7 DTI 16V, 1.7 TD, 1.8 16V, 2.0 16V, 2.0 DI, 2.0 DTI 16V, 2.0 OPC, 2.2 16V, 2.2 DTI	Soft Version; without ball bearing	E	'E	'H	MO6848
Tie Rod Axle Joint	1.2 16V, 1.4 16V, 1.6, 1.6 16V, 1.7 DTI 16V, 1.7 TD, 1.8 16V, 2.0 16V, 2.0 DI, 2.0 DTI 16V	for OE: 1603213	E	'E	'H	RE5547

ASTRA G Hatchback (F48_, F08_)

02/1998 → 12/2009

Ball Joint	1.0, 1.2 16V, 1.4, 1.4 16V, 1.6, 1.6 16V, 1.7 CDTI, 1.7 DTI 16V, 1.7 TD, 1.8, 1.8 16V, 2.0 16V, 2.0 16V OPC, 2.0 DI, 2.0 DTI 16V, 2.0 OPC, 2.2 16V, 2.2 DTI	with add-on material	E	'E	'H	CJ1089
Rod/Strut, stabiliser	1.0, 1.2 16V, 1.4, 1.4 16V, 1.6, 1.6 16V, 1.7 CDTI, 1.7 DTI 16V, 1.7 TD, 1.8, 1.8 16V, 2.0 16V, 2.0 16V OPC, 2.0 DI, 2.0 DTI 16V, 2.0 OPC, 2.2 16V, 2.2 DTI	Alternative Repair Kit: G7-1517; Material: Plastic	E	'E	'H	CTR2462
Tie Rod End	1.0, 1.2 16V, 1.4, 1.4 16V, 1.6, 1.6 16V, 1.7 CDTI, 1.7 DTI 16V, 1.7 TD, 1.8, 1.8 16V, 2.0 16V, 2.0 16V OPC, 2.0 DI, 2.0 DTI 16V, 2.0 OPC, 2.2 16V, 2.2 DTI		E	'E	'H	CTR5170
Top Strut Mounting	1.2 16V, 1.4 16V, 1.6, 1.6 16V, 1.7 CDTI, 1.7 DTI 16V, 1.7 TD, 1.8 16V, 2.0 16V, 2.0 16V OPC, 2.0 DI, 2.0 DTI 16V, 2.0 OPC, 2.2 16V, 2.2 DTI	Soft Version; without ball bearing	E	'E	'H	MO6848
Tie Rod Axle Joint	1.2 16V, 1.4 16V, 1.6, 1.6 16V, 1.7 DTI 16V, 1.7 TD, 1.8 16V, 2.0 16V, 2.0 16V OPC, 2.0 DI, 2.0 DTI 16V	for OE: 1603213	E	'E	'H	RE5547

ASTRA G Coupe (F07_)

03/2000 → 05/2005

Ball Joint	1.6 16V, 1.8 16V, 2.0 16V Turbo, 2.2 16V, 2.2 DTI	with add-on material	E	'E	'H	CJ1089
Rod/Strut, stabiliser	1.6 16V, 1.8 16V, 2.0 16V Turbo, 2.2 16V, 2.2 DTI	Alternative Repair Kit: G7-1517; Material: Plastic	E	'E	'H	CTR2462
Tie Rod End	1.6 16V, 1.8 16V, 2.0 16V Turbo, 2.2 16V, 2.2 DTI		E	'E	'H	CTR5170
Top Strut Mounting	1.6 16V, 1.8 16V, 2.0 16V Turbo, 2.2 16V, 2.2 DTI	Soft Version; without ball bearing	E	'E	'H	MO6848
Tie Rod Axle Joint	1.8 16V, 2.0 16V Turbo, 2.2 16V	for OE: 1603213	E	'E	'H	RE5547

ASTRA G Box (F70)

01/1999 → 04/2005

Ball Joint	1.6, 1.7 TD, 2.0 DI	with add-on material	E	'E	'H	CJ1089
Rod/Strut, stabiliser	1.6, 1.7 TD, 2.0 DI	Alternative Repair Kit: G7-1517; Material: Plastic	E	'E	'H	CTR2462
Tie Rod End	1.6, 1.7 TD, 2.0 DI		E	'E	'H	CTR5170
Top Strut Mounting	1.6, 1.7 TD, 2.0 DI	Soft Version; without ball bearing	E	'E	'H	MO6848
Tie Rod Axle Joint	1.6, 1.7 TD, 2.0 DI	for OE: 1603213	E	'E	'H	RE5547

				
CJ1089	CTR2462	CTR5170	MO6848	RE5547
Ref.Nr.: 90542995	Ref.Nr.: 350614	Ref.Nr.: 26059294	Ref.Nr.: 344523	Ref.Nr.: 1603213

Article Description			Fitting Position	Article No.
---------------------	---	---	------------------	-------------

ASTRA G Saloon (F69_)

09/1998 → 12/2009

Ball Joint	1.216V, 1.4, 1.4 16V, 1.6, 1.6 16V, 1.7 CDTI, 1.7 DTI 16V, 1.7 TD, 1.8 16V, 2.0 16V, 2.0 DI, 2.0 DTI 16V, 2.2 16V, 2.2	with add-on material	E	E	H	CJ1089
Rod/Strut, stabiliser	1.216V, 1.4, 1.4 16V, 1.6, 1.6 16V, 1.7 CDTI, 1.7 DTI 16V, 1.7 TD, 1.8 16V, 2.0 16V, 2.0 DI, 2.0 DTI 16V, 2.2 16V, 2.2	Alternative Repair Kit: G7-1517; Material: Plastic	E	E	H	CTR2462
Tie Rod End	1.216V, 1.4, 1.4 16V, 1.6, 1.6 16V, 1.7 CDTI, 1.7 DTI 16V, 1.7 TD, 1.8 16V, 2.0 16V, 2.0 DI, 2.0 DTI 16V, 2.2 16V, 2.2		E	E	H	CTR5170
Top Strut Mounting	1.216V, 1.4 16V, 1.6, 1.6 16V, 1.7 CDTI, 1.7 DTI 16V, 1.7 TD, 1.8 16V, 2.0 16V, 2.0 DI, 2.0 DTI 16V, 2.2 16V, 2.2 DTI	Soft Version; without ball bearing	E	E	H	MO6848
Tie Rod Axle Joint	1.2 16V, 1.4 16V, 1.6, 1.6 16V, 1.7 DTI 16V, 1.7 TD, 1.8 16V, 2.0 16V, 2.0 DI, 2.0 DTI 16V	for OE: 1603213	E	E	H	RE5547

ASTRA H (L48)

03/2004 → 10/2004

Ball Joint	1.2, 1.3 CDTI, 1.4, 1.4 LPG, 1.6, 1.6 Turbo, 1.7 CDTI, 1.8, 1.9 CDTI, 1.9 CDTI 16V, 2.0 Turbo	with add-on material	E	E	H	CJ1089
Rod/Strut, stabiliser	1.2, 1.3 CDTI, 1.4, 1.4 LPG, 1.6, 1.6 Turbo, 1.7 CDTI, 1.8, 1.9 CDTI, 1.9 CDTI 16V, 2.0 Turbo	Alternative Repair Kit: G7-1517; Material: Plastic; for vehicles without IDS suspension	E	E	H	CTR2462

ASTRA H Estate (L35)

08/2004 →

Ball Joint	1.3 CDTI, 1.4, 1.4 LPG, 1.6, 1.6 LPG, 1.6 Turbo, 1.7 CDTI, 1.8, 1.9 CDTI, 1.9 CDTI 16V, 2.0 Turbo	with add-on material	E	E	H	CJ1089
Rod/Strut, stabiliser	1.3 CDTI, 1.4, 1.4 LPG, 1.6, 1.6 LPG, 1.6 Turbo, 1.7 CDTI, 1.8, 1.9 CDTI, 1.9 CDTI 16V, 2.0 Turbo	Alternative Repair Kit: G7-1517; Material: Plastic; for vehicles without IDS suspension	E	E	H	CTR2462

ASTRA H Sport Hatch (L08)

03/2005 →

Ball Joint	1.2, 1.3 CDTI, 1.4, 1.6, 1.6 Turbo, 1.7 CDTI, 1.8, 1.9 CDTI, 1.9 CDTI 16V, 2.0 Turbo	with add-on material	E	E	H	CJ1089
Rod/Strut, stabiliser	1.2, 1.3 CDTI, 1.4, 1.6, 1.6 Turbo, 1.7 CDTI, 1.8, 1.9 CDTI, 1.9 CDTI 16V, 2.0 Turbo	Alternative Repair Kit: G7-1517; Material: Plastic; for vehicles without IDS suspension	E	E	H	CTR2462

ASTRA H Saloon (L69)

02/2007 →

Ball Joint	1.3 CDTi, 1.6, 1.7 CDTi, 1.8	with add-on material	E	E	H	CJ1089
Rod/Strut, stabiliser	1.3 CDTi, 1.6, 1.7 CDTi, 1.8	Alternative Repair Kit: G7-1517; Material: Plastic; for vehicles without IDS suspension	E	E	H	CTR2462

CALIBRA A (85_)

06/1990 → 07/1997

Control Arm-/Trailing Arm Bush	2.0 i 16V, 2.0 i 16V 4x4		E	E	H	BS6383
Control Arm-/Trailing Arm Bush	2.0 i, 2.0 i 4x4, 2.0 i Turbo 4x4, 2.5 i V6	ch.R9003127→	E	E	H	BS6383
Control Arm-/Trailing Arm Bush	2.0 i 16V, 2.0 i 16V 4x4		E	E	H	BS6406
Control Arm-/Trailing Arm Bush	2.0 i, 2.0 i 4x4, 2.0 i Turbo 4x4, 2.5 i V6	ch.→R9003126	E	E	H	BS6406
Track Control Arm	2.0 i 16V, 2.0 i 16V 4x4, 2.0 i Turbo 4x4, 2.5 i V6		E	E		CJ1501L
Track Control Arm	2.0 i, 2.0 i 4x4	ch.→R9003126	E	E		CJ1501L
Track Control Arm	2.0 i 16V, 2.0 i 16V 4x4, 2.0 i Turbo 4x4, 2.5 i V6		E		H	CJ1501R
Track Control Arm	2.0 i, 2.0 i 4x4	ch.→R9003126	E		H	CJ1501R
Ball Joint	2.0 i, 2.0 i 16V, 2.0 i 16V 4x4, 2.0 i 4x4, 2.0 i Turbo 4x4	ch.→S1999999, S9999999; with add-on material	E	E	H	CJ951
Tie Rod End	2.0 i, 2.0 i 16V, 2.0 i 16V 4x4, 2.0 i 4x4, 2.0 i Turbo 4x4, 2.5 i V	for OE: 324055	E	E		CTR5427L
Tie Rod End	2.0 i, 2.0 i 16V, 2.0 i 16V 4x4, 2.0 i 4x4, 2.0 i Turbo 4x4, 2.5 i V	for OE: 324056	E		H	CTR5427R
Rod/Strut, stabiliser	2.0 i, 2.0 i 16V, 2.0 i 16V 4x4, 2.0 i 4x4, 2.0 i Turbo 4x4, 2.5 i V	for OE: 350 263	E	E	H	CTR5643

						
BS6383	BS6406	CJ1089	CJ1501L	CJ1501R	CJ951	CTR2462
Ref.Nr.: 90268463	Ref.Nr.: 90373778	Ref.Nr.: 90542995	Ref.Nr.: 0352077	Ref.Nr.: 0352192	Ref.Nr.: 1603163	Ref.Nr.: 350614
						
CTR5170	CTR5427L	CTR5427R	CTR5643	MO6848	RE5547	
Ref.Nr.: 26059294	Ref.Nr.: 90350447	Ref.Nr.: 0324054	Ref.Nr.: 4400040	Ref.Nr.: 344523	Ref.Nr.: 1603213	

Article Description			Fitting Position	Article No.
---------------------	---	---	------------------	-------------

COMBO B

07/1994 → 10/2001

Ball Joint	1.2, 1.4, 1.4 16V, 1.7 D	ch.V3023598, V4166926, V6066280→	E	'E	'H	CJ869
Tie Rod End	1.2, 1.4, 1.7 D		E	'E	'H	CTR5500
Tie Rod End	1.2, 1.4, 1.4 16V, 1.7 D	ch.→V3023597, V4166925, V6066279	E	'E	'H	CTR5506
Tie Rod Axle Joint	1.2, 1.4, 1.7 D	for OE: 322158; for vehicles with power steering	E	'E	'H	RE5815

COMBO C

10/2001 →

Suspension Kit	1.3CDTI16V, 1.4 16V, 1.6, 1.6CNG 16V, 1.7CDTI16V, 1.7 DI 16V, 1.7 DTI16V	with fastening material; for vehicles without off-road suspension	E	'E	'H	BS6102
Control Arm-/Trailing Arm Bush	1.3CDTI16V, 1.4 16V, 1.6, 1.6CNG 16V, 1.7CDTI16V, 1.7 DI 16V, 1.7 DTI16V		E	'E	'H	BS6103
Ball Joint	1.3CDTI16V, 1.4 16V, 1.6, 1.6CNG 16V, 1.7CDTI16V, 1.7 DI 16V, 1.7 DTI16V	Number of mounting bores: 3; with fastening material	E	'E	'H	CJ654
Tie Rod End	1.3CDTI16V, 1.4 16V, 1.6, 1.6CNG 16V, 1.7CDTI16V, 1.7 DI 16V, 1.7 DTI16V		E	'E	'H	CTR5506
Rod/Strut, stabiliser	1.3CDTI16V, 1.4 16V, 1.6, 1.6CNG 16V, 1.7CDTI16V, 1.7 DI 16V, 1.7 DTI16V	Material: Metal	E	'E	'H	CTR5771
Tie Rod Axle Joint	1.3CDTI16V, 1.4 16V, 1.6, 1.6CNG 16V, 1.7CDTI16V, 1.7 DI 16V, 1.7 DTI16V	for vehicles with power steering	E	'E	'H	RE056
Tie Rod Axle Joint	1.3CDTI16V, 1.4 16V, 1.6, 1.6CNG 16V, 1.7CDTI16V, 1.7 DI 16V, 1.7 DTI16V	ch.→33999999, 34999999, 36999999	E	'E	'H	RE5499

CORSA B











01/1996 → 12/2002

Ball Joint	130I,160I LITE,CHILL,SEDAN	Lotus Suspension 1998-1999	E	'E	'H	CJ869
Tie Rod End	130I,160I LITE,CHILL,SEDAN	(Long) Lotus Suspension 1998-1999	E	'E	'H	CTR5500
Tie Rod End	130I,160I LITE,CHILL,SEDAN	(Short) Pre Lotus Suspension 1996-1998	E	'E	'H	CTR5506
Rod/Strut, stabiliser	130I,160I LITE,CHILL,SEDAN		E	'E	'H	CTR5771
Tie Rod Axle Joint	130I,160I LITE,CHILL,SEDAN	285 mm P/S	E	'E	'H	RE056
Rack End	130I,160I LITE,CHILL,SEDAN	310 mm M/S	E	'E	'H	RE1609
Tie Rod Axle Joint	130I,160I LITE,CHILL,SEDAN	305 mm M/S	E	'E	'H	RE5499
Tie Rod Axle Joint	130I,160I LITE,CHILL,SEDAN	280 mm M/S	E	'E	'H	RE5815

CORSA B PICKUP

01/1996 → 12/2002

Ball Joint	130I,160I LITE,CHILL,SEDAN	Lotus Suspension 1998-1999	E	'E	'H	CJ869
Tie Rod End	130I,160I LITE,CHILL,SEDAN	(Long) Lotus Suspension 1998-1999	E	'E	'H	CTR5500
Tie Rod End	130I,160I LITE,CHILL,SEDAN	(Short) Pre Lotus Suspension 1996-1998	E	'E	'H	CTR5506
Rod/Strut, stabiliser	130I,160I LITE,CHILL,SEDAN		E	'E	'H	CTR5771
Tie Rod Axle Joint	130I,160I LITE,CHILL,SEDAN	285 mm P/S	E	'E	'H	RE056
Rack End	130I,160I LITE,CHILL,SEDAN	310 mm M/S	E	'E	'H	RE1609
Tie Rod Axle Joint	130I,160I LITE,CHILL,SEDAN	305 mm M/S	E	'E	'H	RE5499
Tie Rod Axle Joint	130I,160I LITE,CHILL,SEDAN	280 mm M/S	E	'E	'H	RE5815

						
BS6102	BS6103	CJ654	CJ869	CTR5500	CTR5506	CTR5771
Ref.Nr.: 352309	Ref.Nr.: 24430103	Ref.Nr.: 9196394	Ref.Nr.: 1603302	Ref.Nr.: 324066	Ref.Nr.: 26087868	Ref.Nr.: 90496116
						
RE056	RE1609	RE5499	RE5815			
Ref.Nr.: 1603843	Ref.Nr.:	Ref.Nr.: 26087867	Ref.Nr.: 322158			

Article Description			Fitting Position	Article No.
---------------------	---	---	------------------	-------------

CORSA C

01/2000 → 12/2002

Suspension Kit	140I,160I,CLASIC,ACTIVE,GSI		E	E	H	BS6102
Control Arm-/Trailing Arm Bush	140I,160I,CLASIC,ACTIVE,GSI		E	E	H	BS6103
Ball Joint	140I,160I,CLASIC,ACTIVE,GSI		E	E	H	CJ869
Tie Rod End	140I,160I,CLASIC,ACTIVE,GSI	Long	E	E	H	CTR5500
Tie Rod End	140I,160I,CLASIC,ACTIVE,GSI	Short	E	E	H	CTR5506
Rod/Strut, stabiliser	140I,160I,CLASIC,ACTIVE,GSI		E	E	H	CTR5771
Top Strut Mounting	140I,160I,CLASIC,ACTIVE,GSI	Shock Mounting Front	E	E	H	MO6848
Tie Rod Axle Joint	140I,160I,CLASIC,ACTIVE,GSI	285 mm P/S	E	E	H	RE056
Rack End	140I,160I,CLASIC,ACTIVE,GSI	310 mm M/S	E	E	H	RE1609
Tie Rod Axle Joint	140I,160I,CLASIC,ACTIVE,GSI	305 mm M/S	E	E	H	RE5499
Tie Rod Axle Joint	140I,160I,CLASIC,ACTIVE,GSI	280 mm M/S	E	E	H	RE5815

CORSA C













01/2002 → 12/2008

Suspension Kit	140I,160I,1.7DTI,1.8I CLASSIC,ACTIVE,GSI,ELEGANCE,		E	E	H	BS6102
Control Arm-/Trailing Arm Bush	140I,160I,1.7DTI,1.8I CLASSIC,ACTIVE,GSI,ELEGANCE,		E	E	H	BS6103
Ball Joint	140I,160I,1.7DTI,1.8I CLASSIC,ACTIVE,GSI,ELEGANCE,		E	E	H	CJ654
Tie Rod End	140I,160I,1.7DTI,1.8I CLASSIC,ACTIVE,GSI,ELEGANCE,	Long	E	E	H	CTR5500
Rod/Strut, stabiliser	140I,160I,1.7DTI,1.8I CLASSIC,ACTIVE,GSI,ELEGANCE,		E	E	H	CTR5771
Top Strut Mounting	140I,160I,1.7DTI,1.8I CLASSIC,ACTIVE,GSI,ELEGANCE,	Shock Mounting Front	E	E	H	MO6848
Tie Rod Axle Joint	140I,160I,1.7DTI,1.8I CLASSIC,ACTIVE,GSI,ELEGANCE,	285 mm P/S	E	E	H	RE056
Rack End	140I,160I,1.7DTI,1.8I CLASSIC,ACTIVE,GSI,ELEGANCE,	310 mm M/S	E	E	H	RE1609
Tie Rod Axle Joint	140I,160I,1.7DTI,1.8I CLASSIC,ACTIVE,GSI,ELEGANCE,	305 mm M/S	E	E	H	RE5499
Tie Rod Axle Joint	140I,160I,1.7DTI,1.8I CLASSIC,ACTIVE,GSI,ELEGANCE,	280 mm M/S	E	E	H	RE5815

CORSA C UTILITY

01/2002 →

Suspension Kit	1.4I,1.7DTI,1.8I		E	E	H	BS6102
Control Arm-/Trailing Arm Bush	1.4I,1.7DTI,1.8I		E	E	H	BS6103
Ball Joint	1.4I,1.7DTI,1.8I		E	E	H	CJ654
Tie Rod End	1.4I,1.7DTI,1.8I	Long	E	E	H	CTR5500
Rod/Strut, stabiliser	1.4I,1.7DTI,1.8I		E	E	H	CTR5771
Top Strut Mounting	1.4I,1.7DTI,1.8I	Shock Mounting Front	E	E	H	MO6848
Tie Rod Axle Joint	1.4I,1.7DTI,1.8I	285 mm P/S	E	E	H	RE056
Rack End	1.4I,1.7DTI,1.8I	310 mm M/S	E	E	H	RE1609
Tie Rod Axle Joint	1.4I,1.7DTI,1.8I	305 mm M/S	E	E	H	RE5499
Tie Rod Axle Joint	1.4I,1.7DTI,1.8I	280 mm M/S	E	E	H	RE5815

						
BS6102	BS6103	CJ654	CJ869	CTR5500	CTR5506	CTR5771
Ref.Nr.: 352309	Ref.Nr.: 24430103	Ref.Nr.: 9196394	Ref.Nr.: 1603302	Ref.Nr.: 324066	Ref.Nr.: 26087868	Ref.Nr.: 90496116
						
MO6848	RE056	RE1609	RE5499	RE5815		
Ref.Nr.: 344523	Ref.Nr.: 1603843	Ref.Nr.:	Ref.Nr.: 26087867	Ref.Nr.: 322158		

Article Description			Fitting Position	Article No.
---------------------	---	---	------------------	-------------

KADET

01/1993 → 12/1999

Track Control Arm	140,160I,180I,200I,S,TS		E	'E		CJ1501L
Track Control Arm	140,160I,180I,200I,S,TS		E		'H	CJ1501R
Ball Joint	140,160I,180I,200I,S,TS		E	'E	'H	CJ951
Tie Rod End	140,160I,180I,200I,S,TS		E	'E		CTR5427L
Tie Rod End	140,160I,180I,200I,S,TS		E		'H	CTR5427R
Rod/Strut, stabiliser	140,160I,180I,200I,S,TS		E	'E	'H	CTR5643

MERIVA A

05/2003 → 05/2010

Suspension Kit	1.3CDTI, 1.4 16V Twinport, 1.4 16V Twinport LPG, 1.6, 1.6 16V, 1.7 CDTI, 1.7 DTI, 1.8	with fastening material	E	'E	'H	BS6102
Control Arm-Trailing Arm Bush	1.3CDTI, 1.4 16V Twinport, 1.4 16V Twinport LPG, 1.6, 1.6 16V, 1.6 Turbo, 1.7 CDTI, 1.7 DTI, 1.8		E	'E	'H	BS6103
Rod/Strut, stabiliser	1.3CDTI, 1.4 16V Twinport, 1.4 16V Twinport LPG, 1.6, 1.6 16V, 1.6 Turbo, 1.7 CDTI, 1.7 DTI, 1.8	Material: Metal	E	'E	'H	CTR5771
Top Strut Mounting	1.6, 1.6 16V, 1.7 CDTI, 1.7 DTI	Soft Version; without ball bearing	E	'E	'H	MO6848

MERIVA B

06/2010 →

Ball Joint	1.3 CDTI, 1.4, 1.7 CDTI	with add-on material	E	'E	'H	CJ1089
------------	-------------------------	----------------------	---	----	----	--------

ZAFIRA A (F75_)













04/1999 → 06/2005

Ball Joint	1.6, 1.6 16V, 1.6 CNG, 1.8, 1.8 16V, 2.0 DI 16V, 2.0 DTI 16V, 2.0 OPC, 2.2 16V, 2.2 DTI 16V	with add-on material	E	'E	'H	CJ1089
Rod/Strut, stabiliser	1.6, 1.6 16V, 1.6 CNG, 1.8, 1.8 16V, 2.0 DI 16V, 2.0 DTI 16V, 2.0 OPC, 2.2 16V, 2.2 DTI 16V	Alternative Repair Kit: G7-1517; Material: Plastic	E	'E	'H	CTR2462
Tie Rod End	1.6, 1.6 16V, 1.6 CNG, 1.8, 1.8 16V, 2.0 DI 16V, 2.0 DTI 16V, 2.0 OPC, 2.2 16V, 2.2 DTI 16V		E	'E	'H	CTR5170
Top Strut Mounting	1.6, 1.6 16V, 1.6 CNG, 1.8, 1.8 16V, 2.0 DI 16V, 2.0 DTI 16V, 2.0 OPC, 2.2 16V, 2.2 DTI 16V	Soft Version; without ball bearing	E	'E	'H	MO6848
Tie Rod Axle Joint	1.6 16V, 1.6 CNG, 1.8 16V, 2.0 DI 16V, 2.0 DTI 16V, 2.0 OPC, 2.2 16V, 2.2 DTI 16V		E	'E	'H	RE5547



ZAFIRA B (A05)

07/2005 →

Ball Joint	1.6, 1.6 CNG, 1.6 CNG Turbo, 1.7 CDTI, 1.8, 1.9 CDTI, 2.0, 2.2	with add-on material	E	'E	'H	CJ1089
Rod/Strut, stabiliser	1.6, 1.6 CNG, 1.6 CNG Turbo, 1.7 CDTI, 1.8, 1.9 CDTI, 2.0, 2.2	Alternative Repair Kit: G7-1517; Material: Plastic; for vehicles without IDS suspension	E	'E	'H	CTR2462

						
BS6102	BS6103	CJ1089	CJ1501L	CJ1501R	CJ951	CTR2462
Ref.Nr.: 352309	Ref.Nr.: 24430103	Ref.Nr.: 90542995	Ref.Nr.: 0352077	Ref.Nr.: 0352192	Ref.Nr.: 1603163	Ref.Nr.: 350614
						
CTR5170	CTR5427L	CTR5427R	CTR5643	CTR5771	MO6848	RE5547
Ref.Nr.: 26059294	Ref.Nr.: 90350447	Ref.Nr.: 0324054	Ref.Nr.: 4400040	Ref.Nr.: 90496116	Ref.Nr.: 344523	Ref.Nr.: 1603213

PEUGEOT

Article Description			Fitting Position	Article No.
206 CC (2D)			09/2000 →	
Tie Rod Axle Joint	1.6 16V, 1.6 HDi 110, 2.0 S16		E	'E 'H RE5651
206 Hatchback (2A/C)			08/1998 → 11/2001	
Tie Rod Axle Joint	1.1, 1.1 i, 1.4 16V, 1.4 HDi eco 70, 1.4 i, 1.6 16V, 1.6 HDi 110, 1.6 i, 1.9 D, 2.0 HDi 90, 2.0 RC, 2.0 S16		E	'E 'H RE5651
206 SW (2E/K)			07/2002 →	
Tie Rod Axle Joint	1.1, 1.4, 1.4 16V, 1.4 HDi, 1.6 16V, 1.6 HDi 110, 2.0 16V, 2.0 HDi		E	'E 'H RE5651
206 Saloon			03/2007 →	
Tie Rod Axle Joint	1.4, 1.6 16V		E	'E 'H RE5651
307 (3A/C)			08/2000 →	
Rod/Strut, stabiliser	1.4 16V, 1.4 HDi, 1.6 HDi, 1.6 HDi 110, 2.0 16V, 2.0 HDi 135	Material: Steel	E	'E 'H CTR6130
Rod/Strut, stabiliser	1.4, 1.6 16V, 2.0 16V, 2.0 HDi 110, 2.0 HDi 90	01/2001 →; Material: Steel	E	'E 'H CTR6130
307 Estate (3E)			03/2002 → 09/2003	
Rod/Strut, stabiliser	1.4, 1.4 16V, 1.4 HDi, 1.6 16V, 1.6 HDi, 1.6 HDi 110, 2.0, 2.0 16V, 2.0 HDi 110, 2.0 HDi 135, 2.0 HDi 90	Material: Steel	E	'E 'H CTR6130
307 CC (3B)			10/2003 →	
Rod/Strut, stabiliser	1.6 16V, 2.0 16V, 2.0 HDi 135	Material: Steel	E	'E 'H CTR6130
307 SW (3H)			03/2002 → 09/2003	
Rod/Strut, stabiliser	1.4, 1.4 16V, 1.6 16V, 1.6 HDi 110, 2.0 16V, 2.0 HDi 110, 2.0 HDi 135, 2.0 HDi 90	Material: Steel	E	'E 'H CTR6130
EXPERT (224)			07/2000 →	
Rod/Strut, stabiliser	2.0 HDi	01/2001 →; Material: Steel	E	'E 'H CTR6130



Article Description			Fitting Position	Article No.
---------------------	---	---	------------------	-------------

924

11/1975 → 08/1989

Track Control Arm	2.0, 2.0 Carrera GT, 2.0 Turbo	ch.F92CN402198, F93CN100306 →; with rubber mounting, without ball joint	E	'E	'H	CJ108
Track Control Arm	2.5 S	with rubber mounting, without ball joint	E	'E	'H	CJ108
Ball Joint	2.0	01/1978 →	E	'E	'H	CJ832
Ball Joint	2.0 Carrera GT, 2.0 Turbo, 2.5 S		E	'E	'H	CJ832

944

06/1981 → 07/1987

Track Control Arm	2.5	→ 01/1985; with rubber mounting, without ball joint	E	'E	'H	CJ108
Ball Joint	2.5	→ 01/1985	E	'E	'H	CJ832

	
<p>CJ108</p>	<p>CJ832</p>
<p>Ref.Nr.: 171407153D</p>	<p>Ref.Nr.: 171407365F</p>

RENAULT

Article Description			Fitting Position	Article No.
---------------------	---	---	------------------	-------------

CLIO Mk II (BB0/1/2_, CB0/1/2_)

09/1998 → 02/2010

Control Arm-/Trailing Arm Bush	1.2, 1.4, 1.4 16V, 1.6, 1.6 16V, 1.9 D, 1.9 dTi, 2.0 16V Sport		E	'E	'H	BS6002
Stabiliser Set	1.0, 1.2, 1.2 16V, 1.2 LPG, 1.4, 1.4 16V, 1.5 dCi, 1.6, 1.6 16V, 1.6 Flex, 1.6 Hi-Flex, 1.9 D, 1.9 dTi, 2.0 16V Sport, 3.0 V6 Sport	→ 09/2008	E			BS8131
Tie Rod End	1.0, 1.2, 1.2 16V, 1.2 LPG, 1.4, 1.4 16V, 1.5 dCi, 1.6, 1.6 16V, 1.6 Hi-Flex, 1.9 D, 1.9 dTi, 2.0 16V Sport, 3.0 V6 Sport	01/2000 →; Manufacturer Restriction: SMI, TRW	E	'E		CTR5726L
Tie Rod End	1.0, 1.2, 1.2 16V, 1.2 LPG, 1.4, 1.4 16V, 1.5 dCi, 1.6, 1.6 16V, 1.6 Hi-Flex, 1.9 D, 1.9 dTi, 2.0 16V Sport, 3.0 V6 Sport	01/2000 →; Manufacturer Restriction: SMI, TRW	E		'H	CTR5726R

CLIO Mk II Box (SB0/1/2_)

09/1998 → 10/2004

Stabiliser Set	1.1, 1.2, 1.5 dCi, 1.9 D, 1.9 DTi	→ 09/2008	E			BS8131
Tie Rod End	1.1, 1.2, 1.5 dCi, 1.9 D, 1.9 DTi	01/2000 →; Manufacturer Restriction: SMI, TRW	E	'E		CTR5726L
Tie Rod End	1.1, 1.2, 1.5 dCi, 1.9 D, 1.9 DTi	01/2000 →; Manufacturer Restriction: SMI, TRW	E		'H	CTR5726R

CLIO Mk III (BR0/1, CR0/1)

05/2005 → 08/2010

Stabiliser Set	1.6 Hi-Flex		E			BS8131
Control Arm-/Trailing Arm Bush	1.2, 1.2 16V, 1.2 16V Hi-Flex, 1.4 16V, 1.5 dCi, 1.6 16V, 1.6 16V GT, 2.0 16V, 2.0 16V Sport		E	'E	'H	BS8147
Control Arm-/Trailing Arm Bush	1.2 16V, 1.2 16V Hi-Flex, 1.4 16V, 1.5 dCi, 1.6 16V, 2.0 16V, 2.0 16V Sport		E	'E	'H	BS8218
Ball Joint	1.4 16V, 1.5 dCi, 1.6 16V	with lock ring	E	'E	'H	CJ1145
Track Control Arm	1.2, 1.2 16V, 1.2 16V Hi-Flex, 1.4 16V, 1.5 dCi, 1.6 16V, 1.6 16V GT, 2.0 16V	Material: Sheet Steel; with ball joint, with rubber mounting	E	'E		CJ299L
Track Control Arm	1.2, 1.2 16V, 1.2 16V Hi-Flex, 1.4 16V, 1.5 dCi, 1.6 16V, 1.6 16V GT, 2.0 16V	Material: Sheet Steel; with ball joint, with rubber mounting	E		'H	CJ299R
Tie Rod End	1.2, 1.2 16V, 1.2 16V Hi-Flex, 1.4 16V, 1.5 dCi, 1.6 16V, 1.6 16V GT, 2.0 16V	Manufacturer Restriction: SMI, TRW	E	'E		CTR5726L
Tie Rod End	1.2, 1.2 16V, 1.2 16V Hi-Flex, 1.4 16V, 1.5 dCi, 1.6 16V, 1.6 16V GT, 2.0 16V	Manufacturer Restriction: SMI, TRW	E		'H	CTR5726R
Rod/Strut, stabiliser	1.2 16V, 1.4 16V, 1.5 dCi, 1.6 16V, 2.0 16V Sport		E	'E	'H	CTR5770

CLIO Mk IV

11/2012 →

Control Arm-/Trailing Arm Bush	0.9TCe 90, 1.2 16V, 1.2TCe 120, 1.5 dCi 75, 1.5 dCi 90		E			BS6819
--------------------------------	--	--	---	--	--	--------

GRAND SCÉNIC II (JM0/1_)



04/2004 →

Control Arm-/Trailing Arm Bush	1.5 dCi, 1.6, 1.9 dCi, 2.0, 2.0 dCi		E			BS6819
Ball Joint	1.5 dCi, 1.6, 1.9 dCi, 2.0	with lock ring	E	'E	'H	CJ1145
Tie Rod Axle Joint	1.5 dCi, 1.6, 1.9 dCi, 2.0		E	'E	'H	RE5902

KANGOO (KC0/1_)

08/1997 → 06/2010

Control Arm-/Trailing Arm Bush	1.2, 1.4, 1.9 dTi, D 55 1.9, D 65 1.9		E	'E	'H	BS6002
Stabiliser Set	1.2, 1.2 16V, 1.4, 1.5 dCi, 1.6, 1.6 16V, 1.6 16V 4x4, 1.9 dCi 4x4, 1.9 dTi, 1.9 RXED, D55 1.9, D65 1.9, Elect'road		E			BS8131
Tie Rod End	1.2	→ 03/2001; Manufacturer Restriction: SMI, TRW; Type: KC01, KC0F; for vehicles with power steering	E	'E		CTR5726L
Tie Rod End	1.2	02/1999 →; Manufacturer Restriction: SMI, TRW; Type: KC0A; for vehicles without power steering	E	'E		CTR5726L
Tie Rod End	1.2	Manufacturer Restriction: SMI, TRW; Type: KC0K; for vehicles with power steering, for vehicles without power steering	E	'E		CTR5726L

						
BS6002	BS6819	BS8131	BS8147	BS8218	CJ1145	CJ299L
Ref.Nr.: 7700424399	Ref.Nr.: 8200041166	Ref.Nr.: 7700799404	Ref.Nr.: 54501BC41A	Ref.Nr.: 54570AX600	Ref.Nr.: 8200679067	Ref.Nr.: 8200744091
						
CJ299R	CTR5726L	CTR5726R	CTR5770	RE5902		
Ref.Nr.: 8200744092	Ref.Nr.: 7701476760	Ref.Nr.: 7701475843	Ref.Nr.: 8200127308	Ref.Nr.: 7701474448		

Article Description			Fitting Position	Article No.
---------------------	---	---	------------------	-------------

KANGOO (KC0/1_)

08/1997 → 06/2010

Tie Rod End	1.2 16V	Manufacturer Restriction: SMI, TRW; Type: KC05, KC06, KC0T, KC0W; for vehicles with power	E	E	CTR5726L
Tie Rod End	1.4	02/1999 →; Manufacturer Restriction: SMI, TRW; Type: KC0C, KC0H; for vehicles with power steering, for vehicles without power steering	E	E	CTR5726L
Tie Rod End	1.4	Manufacturer Restriction: SMI, TRW; Type: KC0B, KC0M; for vehicles with power steering, for vehicles without power steering	E	E	CTR5726L
Tie Rod End	1.5 dCi	Engine Code: K9K 700, K9K702; Manufacturer Restriction: SMI, TRW	E	E	CTR5726L
Tie Rod End	1.5 dCi, 1.6, 1.6 16V, 1.6 16V bivalent, 1.9 dCi 4x4, 1.9 dTi, 1.9 RXED, D 55 1.9	Manufacturer Restriction: SMI, TRW; for vehicles with power steering, for vehicles without power steering	E	E	CTR5726L
Tie Rod End	1.6 16V 4x4	Manufacturer Restriction: SMI, TRW; Type: KC0L, KC0P, KC0S; for vehicles with power steering, for vehicles without power steering	E	E	CTR5726L
Tie Rod End	D 65 1.9	02/1999 →; Manufacturer Restriction: SMI, TRW; Type: KC0E; for vehicles with power steering, for vehicles without power steering	E	E	CTR5726L
Tie Rod End	D 65 1.9	Manufacturer Restriction: SMI, TRW; Type: KC02, KC0J, KC0N; for vehicles with power steering, for vehicles without power steering	E	E	CTR5726L
Tie Rod End	Elect'road RE	Manufacturer Restriction: SMI, TRW	E	E	CTR5726L
Tie Rod End	1.2	→ 03/2001; Manufacturer Restriction: SMI, TRW; Type: KC01, KC0F; for vehicles with power steering	E	H	CTR5726R
Tie Rod End	1.2	02/1999 →; Manufacturer Restriction: SMI, TRW; Type: KC0A; for vehicles without power steering	E	H	CTR5726R
Tie Rod End	1.2	Manufacturer Restriction: SMI, TRW; Type: KC0F; for vehicles without power steering	E	H	CTR5726R
Tie Rod End	1.2	Manufacturer Restriction: SMI, TRW; Type: KC0K; for vehicles with power steering, for vehicles without power steering	E	H	CTR5726R
Tie Rod End	1.2 16V	Manufacturer Restriction: SMI, TRW; Type: KC05, KC06, KC0T, KC0W; for vehicles with power	E	H	CTR5726R
Tie Rod End	1.4	02/1999 →; Manufacturer Restriction: SMI, TRW; Type: KC0C, KC0H; for vehicles with power steering, for vehicles without power steering	E	H	CTR5726R
Tie Rod End	1.4	Manufacturer Restriction: SMI, TRW; Type: KC0B, KC0M; for vehicles with power steering, for vehicles without power steering	E	H	CTR5726R
Tie Rod End	1.5 dCi	Engine Code: K9K 700, K9K702; Manufacturer Restriction: SMI, TRW	E	H	CTR5726R
Tie Rod End	1.5 dCi, 1.6, 1.6 16V, 1.6 16V bivalent, 1.9 dCi 4x4, 1.9 dTi, 1.9 RXED, D 55 1.9	Manufacturer Restriction: SMI, TRW; for vehicles with power steering, for vehicles without power steering	E	H	CTR5726R
Tie Rod End	1.6 16V 4x4	Manufacturer Restriction: SMI, TRW; Type: KC0L, KC0P, KC0S; for vehicles with power steering, for vehicles without power steering	E	H	CTR5726R
Tie Rod End	D 65 1.9	02/1999 →; Manufacturer Restriction: SMI, TRW; Type: KC0E; for vehicles with power steering, for vehicles without power steering	E	H	CTR5726R
Tie Rod End	D 65 1.9	Manufacturer Restriction: SMI, TRW; Type: KC02, KC0J, KC0N; for vehicles with power steering, for vehicles without power steering	E	H	CTR5726R
Tie Rod End	Elect'road RE	Manufacturer Restriction: SMI, TRW	E	H	CTR5726R

	
CTR5726L	CTR5726R
Ref.Nr.: 7701476760	Ref.Nr.: 7701475843

RENAULT





Article Description			Fitting Position	Article No.
---------------------	---	---	------------------	-------------

KANGOO Express (FC0/1_)

08/1997 → 06/2003

Control Arm-/Trailing Arm Bush	1.2 , 1.4 , 1.9 dTi , D 55 1.9 , D 65 1.9		E	'E	H	BS6002
Stabiliser Set	1.2, 1.2 16V, 1.2 BiFuel, 1.4, 1.5 dCi, 1.6 16V, 1.6 16V 4x4 , 1.9 D, 1.9 dCi , 1.9 dCi 4x4 , 1.9 dTi , D 55 1.9 , D 65 1.9		E			BS8131
Tie Rod End	1.0, 1.6 16V, 1.6 16V bivalent, 1.9 D , 1.9 dCi 4x4	Manufacturer Restriction: SMI, TRW	E	'E		CTR5726L
Tie Rod End	1.2	02/1999 →; Manufacturer Restriction: SMI, TRW; Type: FC0A, FC0F; for vehicles with power steering, for vehicles without power steering	E	'E		CTR5726L
Tie Rod End	1.2 , 1.5 dCi	Manufacturer Restriction: SMI, TRW; Type: FC01; for vehicles with power steering, for vehicles without power steering	E	'E		CTR5726L
Tie Rod End	1.2 16V, 1.6 16V 4x4 , 1.9 dCi 4x4 , 1.9 dTi	Manufacturer Restriction: SMI, TRW; for vehicles with power steering, for vehicles without power steering	E	'E		CTR5726L
Tie Rod End	1.2 BiFuel	02/1999 →; Engine Code: D7F 710; Manufacturer Restriction: SMI, TRW	E	'E		CTR5726L
Tie Rod End	1.4	02/1999 →; Manufacturer Restriction: SMI, TRW; Type: FC0C, FC0H; for vehicles with power steering, for vehicles without power steering	E	'E		CTR5726L
Tie Rod End	1.4	Manufacturer Restriction: SMI, TRW; Type: FC0B, FC0M; for vehicles with power steering, for vehicles without power steering	E	'E		CTR5726L
Tie Rod End	1.5 dCi	Manufacturer Restriction: SMI, TRW; Type: FC0A, FC0F; for vehicles with power steering, for vehicles without power steering	E	'E		CTR5726L
Tie Rod End	1.9 dCi	Engine Code: F9Q 790; Manufacturer Restriction: SMI, TRW	E	'E		CTR5726L
Tie Rod End	D 55 1.9	→ 02/1999; Manufacturer Restriction: SMI, TRW; for vehicles with power steering, for vehicles without power steering	E	'E		CTR5726L
Tie Rod End	D 65 1.9	→ 02/1999; Manufacturer Restriction: SMI, TRW; Type: FC02, FC0E; for vehicles with power steering, for vehicles without power steering	E	'E		CTR5726L
Tie Rod End	D 65 1.9	Manufacturer Restriction: SMI, TRW; Type: FC0J, FC0N; for vehicles with power steering, for vehicles without power steering	E	'E		CTR5726L
Tie Rod End	1.0, 1.6 16V, 1.6 16V bivalent, 1.9 D , 1.9 dCi 4x4	Manufacturer Restriction: SMI, TRW	E		H	CTR5726R
Tie Rod End	1.2	02/1999 →; Manufacturer Restriction: SMI, TRW; Type: FC0A, FC0F; for vehicles with power steering, for vehicles without power steering	E		H	CTR5726R
Tie Rod End	1.2 , 1.5 dCi	Manufacturer Restriction: SMI, TRW; Type: FC01; for vehicles with power steering, for vehicles without power steering	E		H	CTR5726R
Tie Rod End	1.2 16V , 1.5 dCi , 1.6 16V 4x4 , 1.9 dCi 4x4 , 1.9 dTi	Manufacturer Restriction: SMI, TRW; for vehicles with power steering, for vehicles without power steering	E		H	CTR5726R
Tie Rod End	1.2 BiFuel	02/1999 →; Engine Code: D7F 710; Manufacturer Restriction: SMI, TRW	E		H	CTR5726R
Tie Rod End	1.4	02/1999 →; Manufacturer Restriction: SMI, TRW; Type: FC0C, FC0H; for vehicles with power steering, for vehicles without power steering	E		H	CTR5726R
Tie Rod End	1.4	Manufacturer Restriction: SMI, TRW; Type: FC0B, FC0M; for vehicles with power steering, for vehicles without power steering	E		H	CTR5726R
Tie Rod End	1.5 dCi	Manufacturer Restriction: SMI, TRW; Type: FC0A, FC0F; for vehicles with power steering, for vehicles without power steering	E		H	CTR5726R

RENAULT

			
BS6002	BS8131	CTR5726L	CTR5726R
Ref.Nr.: 7700424399	Ref.Nr.: 7700799404	Ref.Nr.: 7701476760	Ref.Nr.: 7701475843

Article Description			Fitting Position	Article No.
---------------------	---	---	------------------	-------------

KANGOO Express (FC0/1_)

08/1997 → 06/2003

Tie Rod End	1.9 dCi	Engine Code: F9Q 790; Manufacturer Restriction: SMI, TRW	E		H	CTR5726R
Tie Rod End	D 55 1.9	→ 02/1999; Manufacturer Restriction: SMI, TRW; for vehicles with power steering, for vehicles without power steering	E		H	CTR5726R
Tie Rod End	D 65 1.9	→ 02/1999; Manufacturer Restriction: SMI, TRW; Type: FC02, FC0E; for vehicles with power steering, for vehicles without power steering	E		H	CTR5726R
Tie Rod End	D 65 1.9	Manufacturer Restriction: SMI, TRW; Type: FC0J, FC0N; for vehicles with power steering, for vehicles without power steering	E		H	CTR5726R

KANGOO / GRAND KANGOO (KW0/1_)

02/2008 →

Control Arm-/Trailing Arm Bush	1.5 dCi , 1.5 dCi 110, 1.6, 1.6 16V , 1.6 16V Hi-Flex		E			BS6819
--------------------------------	---	--	---	--	--	--------

KANGOO BE BOP (KW0/1_)

02/2009 →

Control Arm-/Trailing Arm Bush	1.5 dCi , 1.5 dCi 75, 1.6		E			BS6819
--------------------------------	---------------------------	--	---	--	--	--------

KANGOO Express (FW0/1_)

02/2008 →

Control Arm-/Trailing Arm Bush	1.5 dCi , 1.5 dCi 110, 1.5 dCi 75, 1.5 dCi 85, 1.5 dCi 90, 1.6, 1.6 16V, 1.6 16V LPG, Z.E.		E			BS6819
--------------------------------	--	--	---	--	--	--------

LOGAN I (LS_)

09/2004 →

Tie Rod End	1.4, 1.5 dCi, 1.6		E		E	CTR5985L
Tie Rod End	1.4, 1.5 dCi, 1.6		E		H	CTR5985R
Tie Rod Axle Joint	1.4, 1.5 dCi, 1.6		E		E H	RE5986

MEGANE I (BA0/1_)

01/1996 → 08/2003

Tie Rod End	1.4 16V, 1.4 Eco, 1.6 16V, 1.6e, 1.6i, 1.6 LPG, 1.8 16V, 1.9 D Eco, 1.9 dCi, 1.9 dT, 1.9 dTi, 1.9 TDI, 2.0 i	→ 10/2002; Manufacturer Restriction: SMI, TRW	E		E	CTR5726L
Tie Rod End	1.4 e, 2.0 16V	03/1999 →; → 10/2002; Manufacturer Restriction: SMI, TRW	E		E	CTR5726L
Tie Rod End	1.9 DCi	Engine Code: F9Q 732; Manufacturer Restriction: SMI, TRW	E		E	CTR5726L
Tie Rod End	1.4 16V, 1.4 Eco, 1.6 16V, 1.6e, 1.6i, 1.6 LPG, 1.8 16V, 1.9 D Eco, 1.9 dCi, 1.9 dT, 1.9 dTi, 1.9 TDI, 2.0 i	→ 10/2002; Manufacturer Restriction: SMI, TRW	E		H	CTR5726R
Tie Rod End	1.4 e, 2.0 16V	03/1999 →; → 10/2002; Manufacturer Restriction: SMI, TRW	E		H	CTR5726R
Tie Rod End	1.9 DCi	Engine Code: F9Q 732; Manufacturer Restriction: SMI, TRW	E		H	CTR5726R

MEGANE I Cabriolet (EA0/1_)









10/1996 → 08/2003

Ball Joint	2.0 16V	with lock ring	E		E H	CJ1145
Tie Rod End	1.4 16V , 1.6 16V , 1.6 e , 2.0 16V, 2.0 16V IDE , 2.0 i	Manufacturer Restriction: SMI, TRW	E		E	CTR5726L
Tie Rod End	2.0 , 2.0 16V	03/1999 →; Manufacturer Restriction: SMI, TRW	E		E	CTR5726L
Tie Rod End	1.4 16V , 1.6 16V , 1.6 e , 2.0 16V, 2.0 16V IDE , 2.0 i	Manufacturer Restriction: SMI, TRW	E		H	CTR5726R
Tie Rod End	2.0 , 2.0 16V	03/1999 →; Manufacturer Restriction: SMI, TRW	E		H	CTR5726R
Tie Rod Axle Joint	2.0 16V		E		E H	RE5902

MEGANE I Classic (LA0/1_)

09/1996 → 08/2003

Ball Joint	1.6 16V	with lock ring	E		E H	CJ1145
------------	---------	----------------	---	--	-----	--------

						
BS6819	CJ1145	CTR5726L	CTR5726R	CTR5985L	CTR5985R	RE5902
Ref.Nr.: 8200041166	Ref.Nr.: 8200679067	Ref.Nr.: 7701476760	Ref.Nr.: 7701475843	Ref.Nr.: 6001550442	Ref.Nr.: 6001547611	Ref.Nr.: 7701474448
						
RE5986						
Ref.Nr.: 6001550441						

RENAULT

Article Description			Fitting Position	Article No.
---------------------	---	---	------------------	-------------

MEGANE I Classic (LA0/1_) 09/1996 → 08/2003

Tie Rod End	1.416V, 1.616V, 1.6e, 1.6i, 1.816V, 1.9D, 1.9dCi, 1.9dTi, 2.0i	03/1999 →; Manufacturer Restriction: SMI, TRW	E	E		CTR5726L
Tie Rod End	2.0 RT	Engine Code: F3R750, F3R751, F3R752, F3R797, F3R798; Manufacturer Restriction: SMI, TRW	E	E		CTR5726L
Tie Rod End	1.416V, 1.616V, 1.6e, 1.6i, 1.816V, 1.9D, 1.9dCi, 1.9dTi, 2.0i	03/1999 →; Manufacturer Restriction: SMI, TRW	E		H	CTR5726R
Tie Rod End	2.0 RT	Engine Code: F3R750, F3R751, F3R752, F3R797, F3R798; Manufacturer Restriction: SMI, TRW	E		H	CTR5726R

MEGANE II (BM0/1_, CM0/1_) 11/2002 → 12/2009

Control Arm-/Trailing Arm Bush	1.416V, 1.5dCi, 1.6, 1.616V, 1.6Flex-Fuel, 1.9dCi, 2.0, 2.016V Turbo, 2.0dCi, 2.0 Renault Sport		E			BS6819
Ball Joint	1.416V, 1.5dCi, 1.616V, 1.9dCi, 2.016V Turbo, 2.0dCi, 2.0 Renault Sport	with lock ring	E	E	H	CJ1145
Tie Rod Axle Joint	1.416V, 1.5dCi, 1.616V, 1.9dCi, 2.016V Turbo, 2.0dCi, 2.0 Renault Sport		E	E	H	RE5902

MEGANE II Coupé-Cabriolet (EM0/1_) 09/2003 → 12/2009

Control Arm-/Trailing Arm Bush	1.5dCi, 1.6, 1.616V, 1.9dCi, 2.0, 2.016V Turbo, 2.0dCi		E			BS6819
Ball Joint	1.5dCi, 1.6, 1.616V, 1.9dCi, 2.0, 2.016V Turbo, 2.0dCi	with lock ring	E	E	H	CJ1145
Tie Rod Axle Joint	1.5dCi, 1.6, 1.616V, 1.9dCi, 2.0, 2.016V Turbo, 2.0dCi		E	E	H	RE5902

MEGANE II SALOON (LM0/1_) 01/2003 → 12/2005

Control Arm-/Trailing Arm Bush			E	E	H	BS6819
Ball Joint			E	E	H	CJ1145
Tie Rod Axle Joint			E	E	H	RE5902

MEGANE II Sport Tourer (KM0/1_) 08/2003 → 08/2009

Control Arm-/Trailing Arm Bush	1.4, 1.5dCi, 1.6, 1.616V, 1.616V Hi-Flex, 1.9dCi, 2.0, 2.0dCi		E			BS6819
Ball Joint	1.4, 1.5dCi, 1.6, 1.616V, 1.9dCi, 2.0, 2.0dCi	with lock ring	E	E	H	CJ1145
Tie Rod Axle Joint	1.4, 1.5dCi, 1.6, 1.616V, 1.9dCi, 2.0, 2.0dCi		E	E	H	RE5902

MEGANE Scenic (JA0/1_) 10/1996 → 10/1999

Tie Rod End	1.4i, 1.616V, 1.6e, 1.6i, 1.9D, 1.9dT, 1.9dTi, 2.0i, 2.0 RXE 4x4	Manufacturer Restriction: SMI, TRW	E	E		CTR5726L
Tie Rod End	1.4i, 1.616V, 1.6e, 1.6i, 1.9D, 1.9dT, 1.9dTi, 2.0i, 2.0 RXE 4x4	Manufacturer Restriction: SMI, TRW	E		H	CTR5726R

MODUS / GRAND MODUS (F/JP0_) 09/2004 →

Control Arm-/Trailing Arm Bush	1.2, 1.216V, 1.216V Hi-Flex, 1.4, 1.5dCi, 1.6		E	E	H	BS8147
Control Arm-/Trailing Arm Bush	1.2, 1.216V, 1.216V Hi-Flex, 1.4, 1.5dCi, 1.6		E	E	H	BS8218
Ball Joint	1.2, 1.4, 1.6	with lock ring	E	E	H	CJ1145
Track Control Arm	1.2, 1.216V, 1.216V Hi-Flex, 1.4, 1.5dCi, 1.5dCi 90, 1.6	Material: Sheet Steel; with ball joint, with rubber mounting	E	E		CJ299L
Track Control Arm	1.2, 1.216V, 1.216V Hi-Flex, 1.4, 1.5dCi, 1.5dCi 90, 1.6	Material: Sheet Steel; with ball joint, with rubber mounting	E		H	CJ299R
Tie Rod End	1.2, 1.216V, 1.216V Hi-Flex, 1.4, 1.5dCi, 1.5dCi 75, 1.5dCi 90, 1.6	Manufacturer Restriction: SMI, TRW	E	E		CTR5726L
Tie Rod End	1.2, 1.216V, 1.216V Hi-Flex, 1.4, 1.5dCi, 1.5dCi 75, 1.5dCi 90, 1.6	Manufacturer Restriction: SMI, TRW	E		H	CTR5726R

						
BS6819	BS8147	BS8218	CJ1145	CJ299L	CJ299R	CTR5726L
Ref.Nr.: 8200041166	Ref.Nr.: 54501BC41A	Ref.Nr.: 54570AX600	Ref.Nr.: 8200679067	Ref.Nr.: 8200744091	Ref.Nr.: 8200744092	Ref.Nr.: 7701476760
						
CTR5726R	RE5902					
Ref.Nr.: 7701475843	Ref.Nr.: 7701474448					

Article Description			Fitting Position	Article No.
---------------------	---	---	------------------	-------------

MODUS / GRAND MODUS (F/JP0_)

09/2004 →

Rod/Strut, stabiliser	1.2, 1.4, 1.5 dCi, 1.6		E	'E 'H	CTR5770
-----------------------	------------------------	--	---	-------	---------

SANDERO/STEPWAY I

01/2007 →

Ball Joint	1.4, 1.6		E	'E 'H	CJ1145
Tie Rod End	1.4, 1.6		E	'E	CTR5985L
Tie Rod End	1.4, 1.6		E	'H	CTR5985R
Tie Rod Axle Joint	1.4, 1.6		E	'E 'H	RE5986

SCÉNIC I (JA0/1_)

09/1999 → 09/2003

Tie Rod End	1.4 16V, 1.6, 1.6 16V, 1.6 BiFuel, 1.8 16V, 1.8 4x4, 1.9 D, 1.9 dCi, 1.9 dCi RX4, 1.9 dTi, 2.0 16V, 2.0 16V RX4	Manufacturer Restriction: SMI, TRW	E	'E	CTR5726L
Tie Rod End	1.4 16V, 1.6, 1.6 16V, 1.6 BiFuel, 1.8 16V, 1.8 4x4, 1.9 D, 1.9 dCi, 1.9 dCi RX4, 1.9 dTi, 2.0 16V, 2.0 16V RX4	Manufacturer Restriction: SMI, TRW	E	'H	CTR5726R

SCÉNIC II (JM0/1_)

06/2003 →

Control Arm-/Trailing Arm Bush	1.4, 1.5 dCi, 1.6, 1.6 16V, 1.9 D, 1.9 dCi, 2.0, 2.0 16V Turbo, 2.0 dCi		E		BS6819
Ball Joint	1.4, 1.5 dCi, 1.6, 1.9 dCi, 2.0, 2.0 16V Turbo, 2.0 dCi	with lock ring	E	'E 'H	CJ1145
Tie Rod Axle Joint	1.4, 1.5 dCi, 1.6, 1.6 16V, 1.9 dCi, 2.0, 2.0 16V Turbo, 2.0 dCi		E	'E 'H	RE5902

TWINGO I (C06_)

05/1996 → 06/2007

Tie Rod End	1.2 LPG	Engine Code: D7F 702; Manufacturer Restriction: SMI, TRW	E	'E	CTR5726L
Tie Rod End	1.2, 1.2 16V	12/1999 →; Manufacturer Restriction: SMI, TRW	E	'E	CTR5726L
Tie Rod End	1.2 LPG	Engine Code: D7F 702; Manufacturer Restriction: SMI, TRW	E	'H	CTR5726R
Tie Rod End	1.2, 1.2 16V	12/1999 →; Manufacturer Restriction: SMI, TRW	E	'H	CTR5726R

TWINGO I Van (S06_)









05/1996 →

Tie Rod End	1.2	12/1999 →; Manufacturer Restriction: SMI, TRW	E	'E	CTR5726L
Tie Rod End	1.2	12/1999 →; Manufacturer Restriction: SMI, TRW	E	'H	CTR5726R

TWINGO II (CN0_)

03/2007 →

Tie Rod End	1.2, 1.2 16V, 1.2 TCe 100, 1.2 Turbo, 1.5 dCi, 1.5 dCi 75, 1.5 dCi 90, 1.6 RS	Manufacturer Restriction: SMI, TRW	E	'E	CTR5726L
Tie Rod End	1.2, 1.2 16V, 1.2 TCe 100, 1.2 Turbo, 1.5 dCi, 1.5 dCi 75, 1.5 dCi 90, 1.6 RS	Manufacturer Restriction: SMI, TRW	E	'H	CTR5726R

						
BS6819	CJ1145	CTR5726L	CTR5726R	CTR5770	CTR5985L	CTR5985R
Ref.Nr.: 8200041166	Ref.Nr.: 8200679067	Ref.Nr.: 7701476760	Ref.Nr.: 7701475843	Ref.Nr.: 8200127308	Ref.Nr.: 6001550442	Ref.Nr.: 6001547611
						
RE5902	RE5986					
Ref.Nr.: 7701474448	Ref.Nr.: 6001550441					

Article Description			Fitting Position	Article No.
---------------------	---	---	------------------	-------------

900 Mk II

07/1993 → 02/1998

Tie Rod End	2.0 -16 Turbo, 2.0 i, 2.3 -16, 2.5 -24 V6		E	'E		CTR5427L
Tie Rod End	2.0 -16 Turbo, 2.0 i, 2.3 -16, 2.5 -24 V6		E		'H	CTR5427R
Rod/Strut, stabiliser	2.0 -16 Turbo, 2.0 i, 2.3 -16, 2.5 -24 V6	for OE: 350 263	E	'E	'H	CTR5643

900 Mk II Convertible

12/1993 → 02/1998

Tie Rod End	2.0 -16 Turbo, 2.0 i, 2.3 -16, 2.5 -24 V6		E	'E		CTR5427L
Tie Rod End	2.0 -16 Turbo, 2.0 i, 2.3 -16, 2.5 -24 V6		E		'H	CTR5427R
Rod/Strut, stabiliser	2.0 -16 Turbo, 2.0 i, 2.3 -16, 2.5 -24 V6	for OE: 350 263	E	'E	'H	CTR5643

900 Mk II Coupe

12/1993 → 02/1998

Tie Rod End	2.0 -16 Turbo, 2.0 i, 2.3 -16, 2.5 -24 V6		E	'E		CTR5427L
Tie Rod End	2.0 -16 Turbo, 2.0 i, 2.3 -16, 2.5 -24 V6		E		'H	CTR5427R
Rod/Strut, stabiliser	2.0 -16 Turbo, 2.0 i, 2.3 -16, 2.5 -24 V6	for OE: 350 263	E	'E	'H	CTR5643

9-3 (YS3D)

02/1998 → 09/2002

Tie Rod End	2.0i, 2.0SE Turbo, 2.0 Turbo, 2.2 TiD, 2.3, 2.3i, 2.3 Turbo		E	'E		CTR5427L
Tie Rod End	2.0 i, 2.0 SE Turbo, 2.0 Turbo, 2.2 TiD, 2.3 i, 2.3 Turbo		E		'H	CTR5427R
Rod/Strut, stabiliser	2.0i, 2.0SE Turbo, 2.0 Turbo, 2.2 TiD, 2.3, 2.3i, 2.3 Turbo	for OE: 350 263	E	'E	'H	CTR5643

9-3 Cabriolet (YS3D)

02/1998 → 08/2003

Tie Rod End	2.0 i, 2.0 SE Turbo, 2.0 Turbo, 2.3, 2.3 i, 2.3 Turbo		E	'E		CTR5427L
Tie Rod End	2.0 i, 2.0 SE Turbo, 2.0 Turbo, 2.3 i, 2.3 Turbo		E		'H	CTR5427R
Rod/Strut, stabiliser	2.0 i, 2.0 SE Turbo, 2.0 Turbo, 2.3, 2.3 i, 2.3 Turbo	for OE: 350 263	E	'E	'H	CTR5643

9-5 (YS3E)

09/1997 → 12/2009

Ball Joint	2.0 Turbo SE, 2.3 Turbo	with add-on material	E	'E	'H	CJ1089
Ball Joint	2.0, 2.0 t, 2.2 TiD, 2.3 t, 2.3 Turbo, 3.0 TiD, 3.0 V6t	→ 06/2002; with add-on material	E	'E	'H	CJ1089
Rod/Strut, stabiliser	1.9 TiD, 2.0, 2.0 t, 2.0 t BioPower, 2.0 Turbo SE, 2.2 TiD, 2.3, 2.3 t, 2.3 t BioPower, 2.3 Turbo, 3.0 TiD, 3.0 V6t	Material: Metal	E	'E	'H	CTR5771

9-5 Estate (YS3E)

10/1998 → 12/2009

Ball Joint	2.0 t, 2.2 TiD, 2.3 t, 2.3 Turbo, 3.0 TiD, 3.0 V6t	→ 06/2002; with add-on material	E	'E	'H	CJ1089
Ball Joint	2.0, 2.3 Turbo	with add-on material	E	'E	'H	CJ1089
Rod/Strut, stabiliser	1.9 TiD, 2.0, 2.0 t, 2.0 t Biopower, 2.2 TiD, 2.3, 2.3 t, 2.3 t BioPower, 2.3 Turbo, 3.0 TiD, 3.0 V6t	Material: Metal	E	'E	'H	CTR5771

				
CJ1089	CTR5427L	CTR5427R	CTR5643	CTR5771
Ref.Nr.: 90542995	Ref.Nr.: 90350447	Ref.Nr.: 0324054	Ref.Nr.: 4400040	Ref.Nr.: 90496116

Article Description			Fitting Position	Article No.
---------------------	---	---	------------------	-------------

FORESTER (SG)

09/2002 → 08/2005

Rod/Strut, stabiliser	2.0, 2.0 S Turbo, 2.0 X, 2.5, 2.5 All-wheel Drive, 2.5 RX Nato AWD, 2.5 XT	for vehicles with stabiliser	Z 'E 'H	CTR0300
-----------------------	--	------------------------------	---------	---------

IMPREZA Hatchback

12/2002 → 09/2005

Rod/Strut, stabiliser	2.0 All-wheel Drive	07/2003 →; Equipment Variant: STI; not for equipment variant: STI PRODRIVE; for vehicles with stabiliser; Manual Transmission, 6-speed; for vehicles with manual transmission	Z 'E 'H	CTR0300
-----------------------	---------------------	---	---------	---------



IMPREZA Saloon (GD)

11/2001 →

Rod/Strut, stabiliser	2.0 WRX STi	07/2003 →; Equipment Variant: STI; not for equipment variant: STI PRODRIVE; for vehicles with stabiliser; Manual Transmission, 6-speed; for vehicles with manual transmission	Z 'E 'H	CTR0300
Rod/Strut, stabiliser	2.5 WRX STi	Equipment Variant: STI, STI-S; not for equipment variant: STI PRODRIVE; for vehicles with stabiliser; Manual Transmission, 6-speed; for vehicles with manual transmission	Z 'E 'H	CTR0300



SUZUKI

Article Description			Fitting Position	Article No.
ALTO (SS80)				06/1982 → 08/1984
Track Control Arm	0.8		E 'E 'H	CJ1084
ALTO Mk II (EC)				01/1986 → 12/1988
Track Control Arm	0.8		E 'E 'H	CJ1084
ALTO Mk III (EF)				09/1994 → 09/1998
Track Control Arm	1.0		E 'E 'H	CJ1084

SUZUKI



CJ1084

Ref.Nr.: 4520069D00

Article Description			Fitting Position	Article No.
---------------------	---	---	------------------	-------------

AURIS (NRE15_, ZZE15_, ADE15_, ZRE15_, NDE15_)

10/2006 → 09/2012

Rod/Strut, stabiliser	1.4 D-4D, 1.4 VVTi, 1.6 VVTi, 2.0 D-4D, 2.2 D		E	'E 'H	CTR6160
Tie Rod Axle Joint	1.33 Dual-VVTi, 1.4D-4D, 1.4VVTi, 1.5, 1.54WD, 1.6, 1.6 VVTi, 1.8, 1.84WD, 1.8 Hybrid, 1.8 VVTi, 2.0D-4D, 2.2D, 2.4 VVTi, 2.4 VVTi 4x4, 3.5 VVTi 4x4		E	'E 'H	RE5957

AVANZA

01/2006 →

Stabilizer Link	1.3 S,SX 1.5 SX, TX			'E 'H	CTR6211
-----------------	---------------------	--	--	-------	---------

AVENSIS

01/2006 → 12/2008

Track Control Arm	2.0 2.2 2.4		E	'E	CJ266L
Track Control Arm	2.0 2.2 2.4		E	'H	CJ266R
Rod/Strut, stabiliser	2.0 2.2 2.4		E	'E 'H	CTR5916
Tie Rod Axle Joint	2.0 2.2 2.4		E	'E 'H	RE5975

CAMRY

01/1992 → 12/2001

Control Arm-/Trailing Arm Bush	200i SI 220SEI, SI 300SEI		E	'E 'H	BS8424
Tie Rod End	200i SI 220SEI, SI 300SEI		E	'E 'H	CTR5429L

CAMRY

01/2001 → 12/2006

Control Arm-/Trailing Arm Bush	220 GL, GX 2.4 GLI, XLI 3.0 GLX		E	'E 'H	BS8424
Tie Rod End	220 GL, GX 2.4 GLI, XLI 3.0 GLX		E	'E 'H	CTR5429L

CONDOR



01/1998 → 12/2006

Ball Joint	1.8, 2.0I, 2.4I, 3.0		E	'E 'H	CJ281
Tie Rod Axle Joint	1.8, 2.0I, 2.4I, 3.0		E	'E 'H	RE030

CONQUEST

01/1985 → 12/1988

Ball Joint	EE80 1.3 GL, L AE 1.6 GL, RS, RSI		E	'E 'H	CJ935
Tie Rod End	EE80 1.3 GL, L AE 1.6 GL, RS, RSI		E	'E 'H	CTR5343A
Tie Rod Axle Joint	EE80 1.3 GL, L AE 1.6 GL, RS, RSI		E	'E 'H	RE030

						
BS8424	CJ266L	CJ266R	CJ281	CJ935	CTR5343A	CTR5429L
Ref.Nr.: 4865507010	Ref.Nr.: 4806902070	Ref.Nr.: 4806812260	Ref.Nr.: 4333029175	Ref.Nr.: 4333029140	Ref.Nr.: 4504619175	Ref.Nr.: 4504609020
						
CTR5916	CTR6160	CTR6211	RE030	RE5957	RE5975	
Ref.Nr.: 4882047010	Ref.Nr.: 4882042030	Ref.Nr.: 48820B0010	Ref.Nr.: 4550319125	Ref.Nr.: 4550002300	Ref.Nr.: 4550349105	

TOYOTA

Article Description			Fitting Position	Article No.
---------------------	---	---	------------------	-------------

CONQUEST/TAZZ

01/1988 → 12/2006

Ball Joint	EE90 130 SPORT,TAZZ,ZIPP,XE,GS,S,GS,AE92160 RSE, I RS,RSI AE93 180I RSI	1988-1996	E	'E		CJ914
Ball Joint	EE90 130 SPORT,TAZZ,ZIPP,XE,GS,S,GS,AE92160 RSE, I RS,RSI AE93 180I RSI	1988-1996	E		'H	CJ915
Ball Joint	EE90 130 SPORT,TAZZ,ZIPP,XE,GS,S,GS,AE92160 RSE, I RS,RSI AE93 180I RSI	1996-2006	E	'E	'H	CJ949
Tie Rod End	EE90 130 SPORT,TAZZ,ZIPP,XE,GS,S,GS,AE92160 RSE, I RS,RSI AE93 180I RSI		E	'E	'H	CTR5343A
Tie Rod Axle Joint	EE90 130 SPORT,TAZZ,ZIPP,XE,GS,S,GS,AE92160 RSE, I RS,RSI AE93 180I RSI	M/S	E	'E	'H	RE030
Rack End	EE90 130 SPORT,TAZZ,ZIPP,XE,GS,S,GS,AE92160 RSE, I RS,RSI AE93 180I RSI	P/S	E	'E	'H	RE5463

COROLLA

01/1984 → 12/1988

Ball Joint	EE80 1.3 GL,L AE80 GL,AE82 1.6 AVANTE GLE,AVANTE GLI,GLGLE,GLI,SPRINTERGLS,GLX,GLX TWINCAM		E	'E	'H	CJ935
Tie Rod End	EE80 1.3 GL,L AE80 GL,AE82 1.6 AVANTE GLE,AVANTE GLI,GLGLE,GLI,SPRINTERGLS,GLX,GLX TWINCAM		E	'E	'H	CTR5343A
Tie Rod Axle Joint	EE80 1.3 GL,L AE80 GL,AE82 1.6 AVANTE GLE,AVANTE GLI,GLGLE,GLI,SPRINTERGLS,GLX,GLX TWINCAM	M/S	E	'E	'H	RE030

COROLLA

01/1996 → 12/2002

Ball Joint	EE110 130,GLE,AE111 160I GL,GLE,SPRINTER,RSI,RXI,AE112 180I GLE,GSE		E	'E	'H	CJ949	
Tie Rod End	EE110 130,GLE,AE111 160I GL,GLE,SPRINTER,RSI,RXI,AE112 180I GLE,GSE		E	'E	'H	CTR5343A	
Rod/Strut, stabiliser	EE110 130,GLE,AE111 160I GL,GLE,SPRINTER,RSI,RXI,AE112 180I GLE,GSE			Z	'E	'H	CTR5534
Rack End	EE110 130,GLE,AE111 160I GL,GLE,SPRINTER,RSI,RXI,AE112 180I GLE,GSE	P/S	E	'E	'H	RE5463	

COROLLA

01/1988 → 12/1996

Ball Joint	EE90 1.3 GL,GLE,SPRINTER,AE92 160 I GL,GLE,SPRINTER,GLI,GLSAE93180I GSE,GSX,GL,GLE,SPRINTER		E	'E		CJ914	
Ball Joint	EE90 1.3 GL,GLE,SPRINTER,AE92 160 I GL,GLE,SPRINTER,GLI,GLSAE93180I GSE,GSX,GL,GLE,SPRINTER		E		'H	CJ915	
Tie Rod End	EE90 1.3 GL,GLE,SPRINTER,AE92 160 I GL,GLE,SPRINTER,GLI,GLSAE93180I GSE,GSX,GL,GLE,SPRINTER		E	'E	'H	CTR5343A	
Rod/Strut, stabiliser	EE90 1.3 GL,GLE,SPRINTER,AE92 160 I GL,GLE,SPRINTER,GLI,GLSAE93180I GSE,GSX,GL,GLE,SPRINTER			Z	'E	'H	CTR5534
Tie Rod Axle Joint	EE90 1.3 GL,GLE,SPRINTER,AE92 160 I GL,GLE,SPRINTER,GLI,GLSAE93180I GSE,GSX,GL,GLE,SPRINTER	M/S	E	'E	'H	RE030	
Rack End	EE90 1.3 GL,GLE,SPRINTER,AE92 160 I GL,GLE,SPRINTER,GLI,GLSAE93180I GSE,GSX,GL,GLE,SPRINTER	P/S	E	'E	'H	RE5463	

TOYOTA

						
CJ914	CJ915	CJ935	CJ949	CTR5343A	CTR5534	RE030
Ref.Nr.: 4334019015	Ref.Nr.: 4333019066	Ref.Nr.: 4333029140	Ref.Nr.: 4333009640	Ref.Nr.: 4504619175	Ref.Nr.: 4883020010	Ref.Nr.: 4550319125
						
RE5463						
Ref.Nr.: 4550319215						

Article Description			Fitting Position	Article No.
---------------------	---	---	------------------	-------------

COROLLA

01/2002 → 12/2008

Track Control Arm	F11 140I,GLE,GLS,SPRINTER,KS1 160I,GLE,GLS,GLX,GF2 180I GLE,GLS,GSX		E	'E		CJ266L
Track Control Arm	F11 140I,GLE,GLS,SPRINTER,KS1 160I,GLE,GLS,GLX,GF2 180I GLE,GLS,GSX		E		'H	CJ266R
Ball Joint	F11 140I,GLE,GLS,SPRINTER,KS1 160I,GLE,GLS,GLX,GF2 180I GLE,GLS,GSX		E	'E	'H	CJ949
Tie Rod End	F11 140I,GLE,GLS,SPRINTER,KS1 160I,GLE,GLS,GLX,GF2 180I GLE,GLS,GSX		E	'E		CTR5470L
Tie Rod End	F11 140I,GLE,GLS,SPRINTER,KS1 160I,GLE,GLS,GLX,GF2 180I GLE,GLS,GSX		E		'H	CTR5470R
Rod/Strut, stabiliser	F11 140I,GLE,GLS,SPRINTER,KS1 160I,GLE,GLS,GLX,GF2 180I GLE,GLS,GSX		E	'E	'H	CTR5916
Tie Rod Axle Joint	F11 140I,GLE,GLS,SPRINTER,KS1 160I,GLE,GLS,GLX,GF2 180I GLE,GLS,GSX		E	'E	'H	RE2406

COROLLA

01/2008 →

Rod/Strut, stabiliser	1.3 1.6 ADVANCED,IMPACT,PROFESSIONAL 2.0 D4D EXCLUSIVE ADVANCED		E	'E	'H	CTR5916
Rod/Strut, stabiliser	1.3 1.6 ADVANCED,IMPACT,PROFESSIONAL 2.0 D4D EXCLUSIVE ADVANCED		E	'E	'H	CTR6160
Tie Rod Axle Joint	1.3 1.6 ADVANCED,IMPACT,PROFESSIONAL 2.0 D4D EXCLUSIVE ADVANCED	Check Sample	E	'E	'H	RE5957
Tie Rod Axle Joint	1.3 1.6 ADVANCED,IMPACT,PROFESSIONAL 2.0 D4D EXCLUSIVE ADVANCED	Check Sample	E	'E	'H	RE5975

COROLLA Verso (ZDE12_, CDE12_)









09/2001 → 05/2004

Track Control Arm	1.4 D4d, 1.4 VVT-i, 1.6 VVT-i, 1.8 VVT-i, 1.8 VVTi All-wheel Drive, 2.0 D4d, 2.0 D-4D	Material: Sheet Steel; Number of mounting bores: 3; with rubber mounting, without ball joint	E	'E		CJ266L
Track Control Arm	1.4 D4d, 1.4 VVT-i, 1.6 VVT-i, 1.8 VVT-i, 1.8 VVTi All-wheel Drive, 2.0 D4d, 2.0 D-4D	Material: Sheet Steel; Number of mounting bores: 3; with rubber mounting, without ball joint	E		'H	CJ266R
Ball Joint	1.4 D4d, 1.4 VVT-i, 1.6 VVT-i, 1.8 VVT-i, 1.8 VVTi All-wheel Drive, 2.0 D4d, 2.0 D-4D		E	'E	'H	CJ949
Tie Rod End	1.8 VVT-i, 2.0 D-4D		E	'E		CTR5470L
Tie Rod End	1.8 VVT-i, 2.0 D-4D		E		'H	CTR5470R
Rod/Strut, stabiliser	1.4 VVT-i, 1.6 VVT-i, 1.8 VVT-i, 2.0 D-4D	Country Version Japan	E	'E	'H	CTR5916
Tie Rod Axle Joint	1.4 VVT-i, 1.8 VVT-i, 2.0 D-4D		E	'E	'H	RE2406
Tie Rod Axle Joint	1.6 VVT-i	Type: ZZE121R	E	'E	'H	RE2406

COROLLA Verso (ZER_, ZZE12_, R1_)

03/2004 → 03/2009

Track Control Arm	1.4 D-4D, 1.5, 1.6, 1.8, 2.0 D-4D	Material: Sheet Steel; Number of mounting bores: 3; with rubber mounting, without ball joint	E	'E		CJ266L
Track Control Arm	1.4 D-4D, 1.5, 1.6, 1.8, 2.0 D-4D	Material: Sheet Steel; Number of mounting bores: 3; with rubber mounting, without ball joint	E		'H	CJ266R
Ball Joint	1.4 D-4D, 1.5, 1.6, 1.8, 2.0 D-4D		E	'E	'H	CJ949
Rod/Strut, stabiliser	1.6, 1.8, 2.0 D-4D, 2.2 D-4D		E	'E	'H	CTR5916

						
CJ266L	CJ266R	CJ949	CTR5470R	CTR5916	CTR6160	RE2406
Ref.Nr.: 4806902070	Ref.Nr.: 4806812260	Ref.Nr.: 4333009640	Ref.Nr.: 4504649115	Ref.Nr.: 4882047010	Ref.Nr.: 4882042030	Ref.Nr.: 4550312130
						
RE5957	RE5975					
Ref.Nr.: 4550002300	Ref.Nr.: 4550349105					

TOYOTA

Article Description			Fitting Position	Article No.
---------------------	---	---	------------------	-------------

FORTUNER

01/2006 → 12/2015

Ball Joint	3.0 D4D 4.0 V6	Lower	E	'E 'H	CJ1187
Ball Joint	3.0 D4D 4.0 V6	Upper	E	'E 'H	CJ1188
Rod/Strut, stabiliser	3.0 D4D 4.0 V6		E	'E	CTR6014L
Rod/Strut, stabiliser	3.0 D4D 4.0 V6		E	'H	CTR6014R

HI ACE

01/1983 → 12/1992

Ball Joint	YH50/60P/VAN2Y 1.8YH51/613Y 2.0SUPER 10 YH53/63 4 2.2 SUPERT GLX SUPER 14 / 16	Lower Alternative	E	'E 'H	CJ281
Ball Joint	YH50/60P/VAN2Y 1.8YH51/613Y 2.0SUPER 10 YH53/63 4 2.2 SUPERT GLX SUPER 14 / 16	Lower	E	'E 'H	CJ931
Ball Joint	YH50/60P/VAN2Y 1.8YH51/613Y 2.0SUPER 10 YH53/63 4 2.2 SUPERT GLX SUPER 14 / 16	Upper	E	'E 'H	CJ932
Tie Rod End	YH50/60P/VAN2Y 1.8YH51/613Y 2.0SUPER 10 YH53/63 4 2.2 SUPERT GLX SUPER 14 / 16	Outer M17	E	'E 'H	CTR5300
Tie Rod End	YH50/60P/VAN2Y 1.8YH51/613Y 2.0SUPER 10 YH53/63 4 2.2 SUPERT GLX SUPER 14 / 16	Inner M17	E	'E 'H	CTR5317

HI ACE

01/1992 → 12/2008















Ball Joint	YH53/634Y 2.2SUPER 10, SIYAYA, SUPER 14SUPER 16	Lower Alternative	E	'E 'H	CJ281
Ball Joint	YH53/634Y 2.2SUPER 10, SIYAYA, SUPER 14SUPER 16	Lower	E	'E 'H	CJ931
Ball Joint	YH53/634Y 2.2SUPER 10, SIYAYA, SUPER 14SUPER 16	Upper 1993-1995	E	'E 'H	CJ984
Tie Rod End	YH53/634Y 2.2SUPER 10, SIYAYA, SUPER 14SUPER 16	17 mm	E	'E 'H	CTR5005
Tie Rod End	YH53/634Y 2.2SUPER 10, SIYAYA, SUPER 14SUPER 16	15 mm	E	'E 'H	CTR5005A
Tie Rod Axle Joint	YH53/634Y 2.2SUPER 10, SIYAYA, SUPER 14SUPER 16	17 mm	E	'E 'H	RE049
Tie Rod Axle Joint	YH53/634Y 2.2SUPER 10, SIYAYA, SUPER 14SUPER 16	15 mm	E	'E 'H	RE188

HI LUX

01/1974 → 12/1984

Tie Rod End	12R 1.6 18R 2.0 SR5 2.2	Inner M17	E	'E 'H	CTR5300
Tie Rod End	12R 1.6 18R 2.0 SR5 2.2	Outer M17	E	'E 'H	CTR5301

TOYOTA

						
CJ1187	CJ281	CJ931	CJ932	CJ984	CTR5005	CTR5005A
Ref.Nr.: 4333009490	Ref.Nr.: 4333029175	Ref.Nr.: 4333029125	Ref.Nr.: 4335029045	Ref.Nr.: 4335029065	Ref.Nr.: 4504669055	Ref.Nr.: 4504629325
						
CTR5300	CTR5301	CTR5317	CTR6014L	CTR6014R	RE049	RE188
Ref.Nr.: 4504639175	Ref.Nr.: 4540629115	Ref.Nr.: 4540629175	Ref.Nr.:	Ref.Nr.:	Ref.Nr.: 4550329255	Ref.Nr.: 4550329565

Article Description			Fitting Position	Article No.
---------------------	---	---	------------------	-------------

HI LUX

01/1984 → 12/1998

Ball Joint	1Y 1.6 2Y 1.8 3Y 2.0 4Y 2.2 SR SRX RAIDER 2.4 22R 2L RAIDER 3L 2.8 P/UP	Upper	E	'E	'H	CJ933
Ball Joint	1Y 1.6 2Y 1.8 3Y 2.0 4Y 2.2 SR SRX RAIDER 2.4 22R 2L RAIDER 3L 2.8 P/UP	Lower	E	'E	'H	CJ934
Tie Rod End	1Y 1.6 2Y 1.8 3Y 2.0 4Y 2.2 SR SRX RAIDER 2.4 22R 2L RAIDER 3L 2.8 P/UP	Inner M17	E	'E	'H	CTR5300
Tie Rod End	1Y 1.6 2Y 1.8 3Y 2.0 4Y 2.2 SR SRX RAIDER 2.4 22R 2L RAIDER 3L 2.8 P/UP	Outer M17	E	'E	'H	CTR5301

HI LUX

01/1998 → 12/2005

Ball Joint	3RZ-FE 2.7 RAIDER LEGEND 35 5L 3.0D KZ-TE RAISED BODY	Upper	E	'E	'H	CJ981
Tie Rod End	2Y 1.8 RAIDER 1RZ 2.0 DLX,S,SR, 2L 2.4 DLX STANDARD BODY	Inner M17	E	'E	'H	CTR5300
Tie Rod End	3RZ-FE 2.7 RAIDER LEGEND 35 5L 3.0D KZ-TE RAISED BODY	Inner M17	E	'E	'H	CTR5300
Tie Rod End	2Y 1.8 RAIDER 1RZ 2.0 DLX,S,SR, 2L 2.4 DLX STANDARD BODY	Outer M17	E	'E	'H	CTR5301

HI LUX

01/2005 →

Ball Joint	1TRFE 2.0 2KD-FTV 2.5TD1D4D 1KD-FTV 3.0D4D 1GR-FE 4.0 V6	Lower	E	'E	'H	CJ1187
Ball Joint	1TRFE 2.0 2KD-FTV 2.5TD1D4D 1KD-FTV 3.0D4D 1GR-FE 4.0 V6	Upper	E	'E	'H	CJ1188
Rod/Strut, stabiliser	1TRFE 2.0 2KD-FTV 2.5TD1D4D 1KD-FTV 3.0D4D 1GR-FE 4.0 V6 HI RIDER		E	'E		CTR6014L
Rod/Strut, stabiliser	1TRFE 2.0 2KD-FTV 2.5TD1D4D 1KD-FTV 3.0D4D 1GR-FE 4.0 V6 HI RIDER		E		'H	CTR6014R
Stabilizer Link	1TRFE 2.0 2KD-FTV 2.5TD1D4D 1KD-FTV 3.0D4D 1GR-FE 4.0 V6 STANDERD BODY			'E	'H	CTR6115

LAND CRUISER (LJ12_, KZJ12_, TRJ12_, KDJ12_, GRJ12_)

09/2002 → 07/2009

Rod/Strut, stabiliser	2.7 , 3.0 D, 3.0 D-4D , 3.4, 4.0		E	'E		CTR6014L
Rod/Strut, stabiliser	2.7 , 3.0 D, 3.0 D-4D , 3.4, 4.0		E		'H	CTR6014R

LAND CRUISER 150 (KDJ15_, GRJ15_)

01/2010 →

Rod/Strut, stabiliser	2.7 4WD, 3.0D-4D, 4.0V6 Dual VVTi, 4.0V6 VVTi, 4.0V6 VVT-i		E	'E		CTR6014L
Rod/Strut, stabiliser	2.7 4WD, 3.0D-4D, 4.0V6 Dual VVTi, 4.0V6 VVTi, 4.0V6 VVT-i		E		'H	CTR6014R

MR2

01/2001 → 12/2004

Tie Rod Axle Joint	1.8I		E	'E	'H	RE2406
--------------------	------	--	---	----	----	--------

PREVIA (MCR3_, ACR3_, CLR3_)

03/2001 → 01/2006

Tie Rod Axle Joint	2.0 D-4D	03/2003 →	E	'E	'H	RE5975
--------------------	----------	-----------	---	----	----	--------

PRIUS Saloon (NHW11_)

05/2000 → 01/2004

Ball Joint	1.5		E	'E	'H	CJ949
Tie Rod End	1.5		E	'E		CTR5470L
Tie Rod End	1.5		E		'H	CTR5470R
Rod/Strut, stabiliser	1.5	Country Version Japan	E	'E	'H	CTR5916

						
CJ1187	CJ933	CJ934	CJ949	CJ981	CTR5300	CTR5301
Ref.Nr.: 4333009490	Ref.Nr.: 4335039035	Ref.Nr.: 4333039165	Ref.Nr.: 4333009640	Ref.Nr.: 4335039045	Ref.Nr.: 4504639175	Ref.Nr.: 4540629115
						
CTR5470R	CTR5916	CTR6014L	CTR6014R	CTR6115	RE2406	RE5975
Ref.Nr.: 4504649115	Ref.Nr.: 4882047010	Ref.Nr.:	Ref.Nr.:	Ref.Nr.: 488200K010	Ref.Nr.: 4550312130	Ref.Nr.: 4550349105

TOYOTA

Article Description			Fitting Position	Article No.
---------------------	---	---	------------------	-------------

PRIUS Hatchback (NHW20_)

08/2003 → 03/2009

Rod/Strut, stabiliser	1.5		E	'E 'H	CTR5916
-----------------------	-----	--	---	-------	---------

QUANTUM

01/2005 →

Track Control Arm	2.5D BUS P/VAN 2.7i	Upper LHS	E	'E	CJ1168L
Track Control Arm	2.5D BUS P/VAN 2.7i	Upper RHS	E	'H	CJ1168R
Ball Joint	2.5D BUS P/VAN 2.7i	Lower	E	'E 'H	CJ1169
Track Control Arm	2.5D BUS P/VAN 2.7i	Lower LHS	E	'E	CJ1170L
Track Control Arm	2.5D BUS P/VAN 2.7i	Lower RHS	E	'H	CJ1170R
Tie Rod End	2.5D BUS P/VAN 2.7i		E	'E 'H	CTR5812
Tie Rod Axle Joint	2.5D BUS P/VAN 2.7i	15 mm	E	'E 'H	RE188

RAV4 I

01/1994 → 12/2002

Tie Rod End	1.8 SXA10 SUV 2.0 SXA11 SUV		E	'E 'H	CTR5343A
Rack End	1.8 SXA10 SUV 2.0 SXA11 SUV		E	'E 'H	RE5463

RAV4 II

01/2003 → 12/2006

Ball Joint	180,200 SUV		E	'E 'H	CJ949
------------	-------------	--	---	-------	-------

RUNX

01/2003 → 12/2008

Track Control Arm	140I R,RT,160I RS,RT,RX,180I RSI,2.0 RSI		E	'E	CJ266L
Track Control Arm	140I R,RT,160I RS,RT,RX,180I RSI,2.0 RSI		E	'H	CJ266R
Ball Joint	140I R,RT,160I RS,RT,RX,180I RSI,2.0 RSI		E	'E 'H	CJ949
Tie Rod End	140I R,RT,160I RS,RT,RX,180I RSI,2.0 RSI		E	'E	CTR5470L
Tie Rod End	140I R,RT,160I RS,RT,RX,180I RSI,2.0 RSI		E	'H	CTR5470R
Rod/Strut, stabiliser	140I R,RT,160I RS,RT,RX,180I RSI,2.0 RSI		E	'E 'H	CTR5916
Tie Rod Axle Joint	140I R,RT,160I RS,RT,RX,180I RSI,2.0 RSI		E	'E 'H	RE2406

YARIS

01/2005 →

Tie Rod End	1.0 T 1.3 T3		E	'E	CTR5470L
Tie Rod End	1.0 T 1.3 T3		E	'H	CTR5470R
Tie Rod Axle Joint	1.0 T 1.3 T3		E	'E 'H	RE2406

TOYOTA

						
CJ266L	CJ266R	CJ949	CTR5343A	CTR5470R	CTR5812	CTR5916
Ref.Nr.: 4806902070	Ref.Nr.: 4806812260	Ref.Nr.: 4333009640	Ref.Nr.: 4504619175	Ref.Nr.: 4504649115	Ref.Nr.: 4504629456	Ref.Nr.: 4882047010
						
RE188	RE2406	RE5463				
Ref.Nr.: 4550329565	Ref.Nr.: 4550312130	Ref.Nr.: 4550319215				

Article Description			Fitting Position	Article No.
---------------------	---	---	------------------	-------------

C30 10/2006 → 12/2012

Tie Rod End	1.6, 1.6 D, 1.8, 2.0, 2.0 D, 2.4 i, D5, T5		E	'E		CTR5921L
Tie Rod End	1.6, 1.6 D, 1.8, 2.0, 2.0 D, 2.4 i, D5, T5		E		'H	CTR5921R

C70 II Convertible 03/2006 → 06/2013

Tie Rod End	2.4, 2.4 i, D5, T5		E	'E		CTR5921L
Tie Rod End	2.4, 2.4 i, D5, T5		E		'H	CTR5921R
Rod/Strut, stabiliser	2.4, 2.4 i, D5, T5			Z	'E 'H	CTR6191

S40 I (VS) 07/1995 → 12/2003

Rod/Strut, stabiliser	1.6, 1.8, 1.8 i, 1.9 DI, 2.0, 2.0 T, 2.0 T4	01/2001 →	E	'E	'H	CTR6015
Rod/Strut, stabiliser	1.8 i, 2.0 T		E	'E	'H	CTR6015

S40 II (MS) 01/2004 → 12/2012

Ball Joint	1.6, 1.6 D, 1.8, 2.0 D, 2.4, T5, T5 AWD	ch.197553→; Vehicle Production Country The Netherlands	E	'E	'H	CJ1259
Ball Joint	1.6, 1.6 D, 1.8, 2.0 D, 2.4, T5, T5 AWD	ch.209291→; Vehicle Production Country Belgium	E	'E	'H	CJ1259
Tie Rod End	1.6, 1.6 D, 1.8, 2.0 D, 2.4, T5, T5 AWD		E	'E		CTR5921L
Tie Rod End	1.6, 1.6 D, 1.8, 2.0 D, 2.4, T5, T5 AWD		E		'H	CTR5921R
Rod/Strut, stabiliser	1.6, 1.6 D, 1.8, 2.0 D, 2.4, T5, T5 AWD		E			CTR5923
Rod/Strut, stabiliser	1.6 D, 1.8, 2.0, 2.0 D, 2.4, 2.4 D5, T5, T5 AWD			Z	'E 'H	CTR6191

S60 I 07/2000 → 04/2010

Rod/Strut, stabiliser	2.0T, 2.3T5, 2.4, 2.4 Bifuel, 2.4D, 2.4D5, 2.4T, 2.4TAWD, 2.4 T5, 2.5 T, 2.5 T AWD, R 2.5 T AWD, T5		E	'E	'H	CTR5774
-----------------------	---	--	---	----	----	---------

S80 I (TS, XY) 05/1998 → 07/2006

Rod/Strut, stabiliser	2.0, 2.0T, 2.4, 2.4 Bifuel, 2.4D, 2.4D5, 2.4T, 2.5T AWD, 2.5 TDI, 2.8 T6, 2.9, 3.0, 3.0 T6		E	'E	'H	CTR5774
-----------------------	--	--	---	----	----	---------

V40 Estate (VW) 07/1995 → 06/2004

Rod/Strut, stabiliser	1.6, 1.8, 1.8 i, 1.9 DI, 2.0, 2.0 T, 2.0 T4	01/2001 →	E	'E	'H	CTR6015
Rod/Strut, stabiliser	1.8 i, 2.0 T		E	'E	'H	CTR6015

V50 (MW) 04/2004 → 12/2012

Ball Joint	1.6, 1.6 D, 1.8, 2.0 D, 2.4, T5, T5 AWD	ch.214683→	E	'E	'H	CJ1259
Tie Rod End	1.6, 1.6 D, 1.8, 2.0 D, 2.4, T5, T5 AWD		E	'E		CTR5921L
Tie Rod End	1.6, 1.6 D, 1.8, 2.0 D, 2.4, T5, T5 AWD		E		'H	CTR5921R
Rod/Strut, stabiliser	1.6, 1.6 D, 1.8, 2.0 D, 2.4, T5, T5 AWD		E			CTR5923
Rod/Strut, stabiliser	1.6 D, 1.8, 2.0, 2.0 D, 2.4, 2.4 D5, T5, T5 AWD			Z	'E 'H	CTR6191

V70 (LV) 03/1999 → 03/2000



Rod/Strut, stabiliser	2.5 AWD		E	'E	'H	CTR5774
-----------------------	---------	--	---	----	----	---------

V70 Mk II (SW) 03/2000 → 08/2007

Rod/Strut, stabiliser	2.0T, 2.3T5, 2.4, 2.4 Bifuel, 2.4D, 2.4D5, 2.4D5 AWD, 2.4 T, 2.4TAWD, 2.4T5, 2.5 R Sport, 2.5T, 2.5T AWD, 2.5 TDI, R 2.5 T AWD		E	'E	'H	CTR5774
-----------------------	--	--	---	----	----	---------

					
CJ1259	CTR5774	CTR5921R	CTR5923	CTR6015	CTR6191
Ref.Nr.: 1679388	Ref.Nr.: 8634736	Ref.Nr.: 1317446	Ref.Nr.: 3M513B438AB	Ref.Nr.: 30884179	Ref.Nr.: 1310333

VOLVO

Article Description			Fitting Position	Article No.
XC70 CROSS COUNTRY			03/2000 → 08/2007	
Rod/Strut, stabiliser	2.4 D5 AWD, 2.4 D5 XC AWD, 2.4 T XC AWD, 2.5 T XC AWD		E	'E 'H CTR5774
XC90 I			10/2002 → 12/2010	
Rod/Strut, stabiliser	2.5 T, D5, T6, V8		E	'E 'H CTR5774

VOLVO

<p>CTR5774</p>
<p>Ref.Nr.: 8634736</p>

Article Description			Fitting Position	Article No.
---------------------	---	---	------------------	-------------

AMAROK (2H_, S1B)

09/2010 →

Control Arm-/Trailing Arm Bush	2.0BiTDI, 2.0BiTDI 4motion, 2.0 TDI, 2.0 TDI 4motion, 2.0 TS	Rubber-metal Bearing	E	E	H	BS8272
--------------------------------	--	----------------------	---	---	---	--------

NEW BEETLE Convertible (1Y7)

09/2002 → 10/2010

Repair Kit, ball joint	1.4, 1.6, 1.8 T, 1.9 TDI, 2.0		E	E		CJ986
Repair Kit, ball joint	1.4, 1.6, 1.8 T, 1.9 TDI, 2.0		E		H	CJ987
Tie Rod End	1.4, 1.6, 1.8 T, 1.9 TDI, 2.0, 2.5		E	E		CTR5706L
Tie Rod End	1.4, 1.6, 1.8 T, 1.9 TDI, 2.0, 2.5		E		H	CTR5706R
Top Strut Mounting	1.4, 1.6, 1.8 T, 1.9 TDI, 2.0, 2.5	without ball bearing	E	E	H	MO6180
Tie Rod Axle Joint	1.4, 1.6, 1.8 T, 1.9 TDI, 2.0, 2.5		E	E	H	RE8143

NEW BEETLE (9C1, 1C1)

01/1998 → 09/2010

Control Arm-/Trailing Arm Bush	1.4, 1.6, 1.8 T, 1.9 TDI, 2.0, 2.3 V5, RSI 3.2 4motion		E	E	H	BS6417
Control Arm-/Trailing Arm Bush	1.4, 1.6, 1.8 T, 1.9 TDI, 2.0, 2.3 V5, RSI 3.2 4motion		E	E	H	BS6911
Repair Kit, ball joint	1.4, 1.6, 1.8 T, 1.9 TDI, 2.0, 2.3 V5		E	E		CJ986
Repair Kit, ball joint	1.4, 1.6, 1.8 T, 1.9 TDI, 2.0, 2.3 V5		E		H	CJ987
Tie Rod End	1.4, 1.6, 1.8 T, 1.9 TDI, 2.0, 2.3 V5, 2.5	ch.1J-W-047125→	E	E		CTR5706L
Tie Rod End	1.4, 1.6, 1.8 T, 1.9 TDI, 2.0, 2.3 V5, 2.5	ch.1J-W-047125→	E		H	CTR5706R
Top Strut Mounting	1.4, 1.6, 1.8 T, 1.9 TDI, 2.0, 2.3 V5, 2.5, RSI 3.2 4motion	without ball bearing	E	E	H	MO6180
Tie Rod Axle Joint	1.4, 1.6, 1.8 T, 1.9 TDI, 2.3 V5, 2.5		E	E	H	RE8143
Tie Rod Axle Joint	1.9 TDI, 2.0	ch.1J-W-047125→	E	E	H	RE8143

BEETLE (5C1)

04/2011 →

Control Arm-/Trailing Arm Bush	1.2 TSI, 1.4 TSI, 1.6 TDI, 2.0 TDI, 2.0 TSI	Rubber-metal Bearing	E	E	H	BS6899
Rod/Strut, stabiliser	1.2 TSI, 1.4 TSI, 1.6 TDI, 2.0 TDI, 2.0 TSI	Material: Steel	E	E	H	CTR5849

CADDY Mk I / Mk II

01/1982 → 12/2003

Track Control Arm	1.3.1.4. 1.5.1.6.1.8		E	E	H	CJ108
Ball Joint	1.3.1.4. 1.5.1.6.1.8	17 mm	E	E	H	CJ832
Tie Rod End	1.3.1.4. 1.5.1.6.1.8		E	E	H	CTR5140

						
BS6417	BS6899	BS6911	BS8272	CJ108	CJ832	CJ986
Ref.Nr.: 1J0407181	Ref.Nr.: 1K0407182	Ref.Nr.: 191407182	Ref.Nr.: 2H0407183A	Ref.Nr.: 171407153D	Ref.Nr.: 171407365F	Ref.Nr.: 1J0407365A
						
CJ987	CTR5140	CTR5706L	CTR5706R	CTR5849	MO6180	RE8143
Ref.Nr.: 1J0407366H	Ref.Nr.: 32111116463	Ref.Nr.: 1J0422811B	Ref.Nr.: 1J0422812B	Ref.Nr.: 1K0411315G	Ref.Nr.: 1J0412331B	Ref.Nr.: 1J0422807B

Article Description			Fitting Position	Article No.
---------------------	---	---	------------------	-------------

CADDY Mk I / Mk II

01/1982 → 12/2003

Tie Rod Axle Joint	1.3.1.4. 1.5.1.6.1.8		E	'E 'H	RE033
--------------------	----------------------	--	---	-------	-------

CADDY Mk III Box (2KA, 2KH, 2CA, 2CH)

03/2004 → 08/2010

Control Arm-/Trailing Arm Bush	1.4, 1.4 16V, 1.6, 1.9 TDI, 2.0 EcoFuel, 2.0 SDI, 2.0 TDI	Material: Aluminium	E	'E	BS6883
Control Arm-/Trailing Arm Bush	1.4, 1.4 16V, 1.6, 1.9 TDI, 2.0 EcoFuel, 2.0 SDI, 2.0 TDI	Material: Aluminium	E	'H	BS6884
Control Arm-/Trailing Arm Bush	1.2TSI, 1.4, 1.4 16V, 1.6, 1.6BiFuel, 1.6TDI, 1.9TDI, 1.9 TDI 4motion, 2.0EcoFuel, 2.0SDI, 2.0TDI, 2.0TDI 16V, 2.0 TDI 16V 4motion, 2.0 TDI 4motion	Rubber-metal Bearing	E	'E 'H	BS6899
Rod/Strut, stabiliser	1.2TSI, 1.4, 1.4 16V, 1.6, 1.6BiFuel, 1.6TDI, 1.9TDI, 1.9 TDI 4motion, 2.0EcoFuel, 2.0SDI, 2.0TDI, 2.0TDI 16V, 2.0 TDI 16V 4motion, 2.0 TDI 4motion	Material: Steel	E	'E 'H	CTR5849
Tie Rod Axle Joint	1.2TSI, 1.4, 1.4 16V, 1.6, 1.6BiFuel, 1.6TDI, 1.9TDI, 1.9 TDI 4motion, 2.0SDI, 2.0TDI, 2.0EcoFuel, 2.0TDI, 2.0TDI 16V, 2.0 TDI 16V 4motion, 2.0 TDI 4motion		E	'E 'H	RE5841

CADDY Mk III Estate (2KB, 2KJ, 2CB, 2CJ)

03/2004 → 08/2010

Control Arm-/Trailing Arm Bush	1.4, 1.4 16V, 1.6, 1.9 TDI, 1.9 TDI 4motion, 2.0EcoFuel, 2.0 SDI, 2.0 TDI	Material: Aluminium	E	'E	BS6883
Control Arm-/Trailing Arm Bush	1.4, 1.4 16V, 1.6, 1.9 TDI, 1.9 TDI 4motion, 2.0EcoFuel, 2.0 SDI, 2.0 TDI	Material: Aluminium	E	'H	BS6884
Control Arm-/Trailing Arm Bush	1.2TSI, 1.4, 1.4 16V, 1.6, 1.6BiFuel, 1.6TDI, 1.9TDI, 1.9 TDI 4motion, 2.0EcoFuel, 2.0SDI, 2.0TDI, 2.0TDI 16V, 2.0 TDI 16V 4motion, 2.0 TDI 4motion	Rubber-metal Bearing	E	'E 'H	BS6899
Rod/Strut, stabiliser	1.2TSI, 1.4, 1.4 16V, 1.6, 1.6BiFuel, 1.6TDI, 1.9TDI, 1.9 TDI 4motion, 2.0EcoFuel, 2.0SDI, 2.0TDI, 2.0TDI 16V, 2.0 TDI 16V 4motion, 2.0 TDI 4motion	Material: Steel	E	'E 'H	CTR5849
Tie Rod Axle Joint	1.2TSI, 1.4, 1.4 16V, 1.6, 1.6BiFuel, 1.6TDI, 1.9TDI, 1.9 TDI 4motion, 2.0SDI, 2.0TDI, 2.0EcoFuel, 2.0TDI, 2.0TDI 16V, 2.0 TDI 4motion, 2.0 TDI 16V 4motion	for steering gear manufacturer: ZF; for vehicles with electric power steering	E	'E 'H	RE5841

CC (358)















11/2011 →

Control Arm-/Trailing Arm Bush	1.4 TSI, 1.8 TSI, 2.0 TDI, 2.0 TDI 4motion, 2.0 TSI, 3.6 FSI 4motion	Rubber-metal Bearing	E	'E 'H	BS6899
Rod/Strut, stabiliser	1.8 TSI, 2.0 TDI, 2.0 TSI, 3.6 FSI 4motion	Material: Steel	E	'E 'H	CTR5849
Tie Rod Axle Joint	1.8 TSI, 2.0 TDI, 2.0 TSI, 3.6 FSI 4motion	for vehicles with electric power steering	E	'E 'H	RE5841

CORRADO (53I)

09/1988 → 12/1995

Control Arm-/Trailing Arm Bush	1.8 16V, 1.8 G60, 2.0 i, 2.0 i 16V, 2.9 VR6		E	'E 'H	BS6911
Ball Joint	2.9 VR6		E	'E 'H	CJ1031
Ball Joint	1.8 16V, 1.8 G60, 2.0 i, 2.0 i 16V, 2.9 VR6	with fastening material; with accessories	E	'E 'H	CJ864
Tie Rod End	1.8 16V, 1.8 G60, 2.0 i, 2.0 i 16V, 2.9 VR6		E	'E	CTR5191L
Tie Rod End	1.8 16V, 1.8 G60, 2.0 i, 2.0 i 16V, 2.9 VR6		E	'H	CTR5191R
Repair Kit, link	1.8 16V, 1.8 G60, 2.0 i, 2.0 i 16V, 2.9 VR6	with guide sleeve	E	'E 'H	MO5414
Tie Rod Axle Joint	1.8 16V, 1.8 G60, 2.0 i, 2.0 i 16V, 2.9 VR6	for vehicles without power steering	E	'E 'H	RE5192
Tie Rod Axle Joint	1.8 16V, 1.8 G60, 2.0 i, 2.0 i 16V	for vehicles with power steering	E	'E 'H	RE5473

						
BS6883	BS6884	BS6899	BS6911	CJ1031	CJ864	CTR5191L
Ref.Nr.: 1K0199231J	Ref.Nr.: 1K0199232J	Ref.Nr.: 1K0407182	Ref.Nr.: 191407182	Ref.Nr.: 1H0407365	Ref.Nr.: 357407365	Ref.Nr.: 3A0422811
						
CTR5191R	CTR5849	MO5414	RE033	RE5192	RE5473	RE5841
Ref.Nr.: 191419812	Ref.Nr.: 1K0411315G	Ref.Nr.: 191407181D	Ref.Nr.: 171419821	Ref.Nr.: 191419804PAR	Ref.Nr.: 191422804APA	Ref.Nr.: 1K0423810A

Article Description			Fitting Position	Article No.
---------------------	--	--	------------------	-------------

CRAFTER 30-35 Bus (2E_)

04/2006 → 07/2011

Tie Rod End	2.0 TDI, 2.0 TDI 4motion, 2.5 TDI		E	'E	'H	CTR5927
Tie Rod Axle Joint	2.0 TDI, 2.0 TDI 4motion, 2.5 TDI		E	'E	'H	RE5928

CRAFTER 30-50 Box (2E_)

04/2006 → 07/2011

Tie Rod End	2.0 TDI, 2.0 TDI 4motion, 2.5 TDI		E	'E	'H	CTR5927
Tie Rod Axle Joint	2.0 TDI, 2.0 TDI 4motion, 2.5 TDI		E	'E	'H	RE5928

CRAFTER 30-50 Platform/Chassis (2F_)

04/2006 → 07/2011

Tie Rod End	2.0 TDI, 2.0 TDI 4motion, 2.5 TDI		E	'E	'H	CTR5927
Tie Rod Axle Joint	2.0 TDI, 2.0 TDI 4motion, 2.5 TDI		E	'E	'H	RE5928

EOS (1F7, 1F8)

03/2006 → 08/2015

Control Arm-/Trailing Arm Bush	1.4 TSI, 1.6 FSI, 2.0 FSI, 2.0 TDI, 2.0 TFSI, 2.0 TSI, 3.2 V6, 3.6 V6	Material: Aluminium	E	'E		BS6883
Control Arm-/Trailing Arm Bush	1.4 TSI, 1.6 FSI, 2.0 FSI, 2.0 TDI, 2.0 TFSI, 2.0 TSI, 3.2 V6, 3.6 V6	Material: Aluminium	E		'H	BS6884
Control Arm-/Trailing Arm Bush	1.4 TSI, 1.6 FSI, 2.0 FSI, 2.0 TDI, 2.0 TDI 16V, 2.0 TFSI, 2.0 TSI, 3.2 V6, 3.6 V6	Rubber-metal Bearing	E	'E	'H	BS6899
Rod/Strut, stabiliser	1.4 TSI, 1.6 FSI, 2.0 FSI, 2.0 TDI, 2.0 TDI 16V, 2.0 TFSI, 2.0 TSI, 3.2 V6, 3.6 V6	Material: Steel	E	'E	'H	CTR5849
Tie Rod Axle Joint	1.4 TSI, 1.6 FSI, 2.0 FSI, 2.0 TDI, 2.0 TDI 16V, 2.0 TFSI, 3.2 V6, 3.6 V6		E	'E	'H	RE5841

FOX

01/1987 → 12/1995

Track Control Arm	1.3.1.4. 1.5.1.6.1.8		E	'E	'H	CJ108
Ball Joint	1.3.1.4. 1.5.1.6.1.8	17 mm	E	'E	'H	CJ832
Tie Rod End	1.3.1.4. 1.5.1.6.1.8		E	'E	'H	CTR5140
Tie Rod Axle Joint	1.3.1.4. 1.5.1.6.1.8		E	'E	'H	RE033

GOLF 1/CITI/VELOCITY

01/1979 → 12/2010

Track Control Arm	1.3.1.4. 1.5.1.6.1.8		E	'E	'H	CJ108
Ball Joint	1.3.1.4. 1.5.1.6.1.8	17 mm	E	'E	'H	CJ832
Tie Rod End	1.3.1.4. 1.5.1.6.1.8		E	'E	'H	CTR5140
Tie Rod Axle Joint	1.3.1.4. 1.5.1.6.1.8		E	'E	'H	RE033

GOLF Convertible (155)

01/1979 → 04/1993

Track Control Arm	1.5, 1.6, 1.8	with rubber mounting, without ball joint	E	'E	'H	CJ108
Ball Joint	1.5, 1.6, 1.8		E	'E	'H	CJ832
Tie Rod End	1.5, 1.6, 1.8		E	'E	'H	CTR5140
Tie Rod Axle Joint	1.5, 1.6, 1.8		E	'E	'H	RE033

BS6883	BS6884	BS6899	CJ108	CJ832	CTR5140	CTR5849
Ref.Nr.: 1K0199231J	Ref.Nr.: 1K0199232J	Ref.Nr.: 1K0407182	Ref.Nr.: 171407153D	Ref.Nr.: 171407365F	Ref.Nr.: 32111116463	Ref.Nr.: 1K0411315G
CTR5927	RE033	RE5841	RE5928			
Ref.Nr.: 90610481003	Ref.Nr.: 171419821	Ref.Nr.: 1K0423810A	Ref.Nr.: 90610551003			

Article Description			Fitting Position	Article No.
---------------------	---	---	------------------	-------------

GOLF Mk II (19E, 1G1)













08/1983 → 12/1992

Control Arm-/Trailing Arm Bush	1.0, 1.3, 1.3CAT, 1.6, 1.6D, 1.6TD, 1.8, 1.8GTI, 1.8GTI 16V, 1.8 GTI CAT, 1.8 GTI G60, 1.8 GTI G60 Syncro, 1.8 i CAT, 1.8 i Syncro CAT, 1.8 Syncro		E	E	H	BS6911
Ball Joint	1.0, 1.3, 1.3CAT, 1.6, 1.6D, 1.6TD, 1.8, 1.8GTI, 1.8GTI 16V, 1.8 GTI CAT, 1.8 GTI G60, 1.8 GTI G60 Syncro, 1.8 i CAT, 1.8 i Syncro CAT, 1.8 Syncro	with fastening material; with accessories, 19 mm	E	E	H	CJ864
Ball Joint	1.0, 1.3, 1.3CAT, 1.6, 1.6D, 1.6TD, 1.8, 1.8GTI, 1.8GTI 16V, 1.8 GTI CAT, 1.8 Syncro	with accessories, 17 mm	E	E	H	CJ957
Tie Rod End	1.0, 1.3, 1.3CAT, 1.6, 1.6D, 1.6TD, 1.8, 1.8GTI, 1.8GTI 16V, 1.8 GTI CAT, 1.8 GTI G60, 1.8 GTI G60 Syncro, 1.8 i CAT, 1.8 i Syncro CAT, 1.8 Syncro		E	E		CTR5191L
Tie Rod End	1.0, 1.3, 1.3CAT, 1.6, 1.6D, 1.6TD, 1.8, 1.8GTI, 1.8GTI 16V, 1.8 GTI CAT, 1.8 GTI G60, 1.8 GTI G60 Syncro, 1.8 i CAT, 1.8 i Syncro CAT, 1.8 Syncro		E		H	CTR5191R
Repair Kit, link	1.0, 1.3, 1.3CAT, 1.6, 1.6D, 1.6TD, 1.8, 1.8GTI, 1.8GTI 16V, 1.8 GTI CAT, 1.8 GTI G60, 1.8 GTI G60 Syncro, 1.8 i CAT, 1.8 i Syncro CAT, 1.8 Syncro	with guide sleeve	E	E	H	MO5414
Tie Rod Axle Joint	1.0, 1.3, 1.3CAT, 1.6, 1.6D, 1.6TD, 1.8, 1.8GTI, 1.8GTI 16V, 1.8 GTI CAT, 1.8 GTI G60, 1.8 GTI G60 Syncro, 1.8 i CAT, 1.8 i Syncro CAT, 1.8 Syncro	for vehicles without power steering	E	E	H	RE5192
Tie Rod Axle Joint	1.0, 1.3, 1.3CAT, 1.6, 1.6D, 1.6TD, 1.8, 1.8GTI, 1.8GTI 16V, 1.8 GTI CAT, 1.8 GTI G60, 1.8 i CAT, 1.8 i Syncro CAT, 1.8 Syncro	for vehicles with power steering	E	E	H	RE5473

GOLF Mk III

01/1992 → 12/1999

Control Arm-/Trailing Arm Bush	1.6 CSL, 1.8 CLX, CSX, 2.0 CLI 2.8 2.9 VR6	Control Arm Bush Rear ID13/OD60/L41	E	E	H	BS6417
Ball Joint	2.0 2.8 VR6 2.9 VR6	16,5 mm	E	E	H	CJ1031
Track Control Arm	1.6 CSL, 1.8 CLX, CSX, 2.0 CLI	Exc VR6	E	E	H	CJ111L
Ball Joint	1.6 CSL, 1.8 CLX, CSX, 2.0 CLI	19 mm Exc VR6	E	E	H	CJ864
Tie Rod End	1.6 CSL, 1.8 CLX, CSX, 2.0 CLI 2.8 2.9 VR6		E	E		CTR5191L
Tie Rod End	1.6 CSL, 1.8 CLX, CSX, 2.0 CLI 2.8 2.9 VR6		E		H	CTR5191R
Repair Kit, link	1.6 CSL, 1.8 CLX, CSX, 2.0 CLI 2.8 2.9 VR6	Control Arm Bush Rear ID17/OD60/L41	E	E	H	MO5414
Top Strut Mounting	1.6 CSL, 1.8 CLX, CSX, 2.0 CLI 2.8 2.9 VR6	Shock Mounting Front	E	E	H	MO6180
Rack End	1.6 CSL, 1.8 CLX, CSX, 2.0 CLI 2.8 2.9 VR6	P/S	E	E	H	RE5438

						
BS6417	BS6911	CJ1031	CJ111L	CJ864	CJ957	CTR5191L
Ref.Nr.: 1J0407181	Ref.Nr.: 191407182	Ref.Nr.: 1H0407365	Ref.Nr.: 1H0407151	Ref.Nr.: 357407365	Ref.Nr.: 191407365	Ref.Nr.: 3A0422811
						
CTR5191R	MO5414	MO6180	RE5192	RE5438	RE5473	
Ref.Nr.: 191419812	Ref.Nr.: 191407181D	Ref.Nr.: 1J0412331B	Ref.Nr.: 191419804PAR	Ref.Nr.:	Ref.Nr.: 191422804APA	

Article Description			Fitting Position	Article No.
---------------------	--	--	------------------	-------------

GOLF Mk IV

01/1999 → 12/2004

Control Arm-/Trailing Arm Bush	1.6I,1.8 GTI,1.9TDI,STD,COMFORTLINE,HIGHLINE	Control Arm Bush Rear ID13/OD60/L41	E	'E	'H	BS6417
Repair Kit, ball joint	1.6I,1.8 GTI,1.9TDI,STD,COMFORTLINE,HIGHLINE		E	'E		CJ986
Repair Kit, ball joint	1.6I,1.8 GTI,1.9TDI,STD,COMFORTLINE,HIGHLINE		E		'H	CJ987
Tie Rod End	1.6I,1.8 GTI,1.9TDI,STD,COMFORTLINE,HIGHLINE		E	'E		CTR5706L
Tie Rod End	1.6I,1.8 GTI,1.9TDI,STD,COMFORTLINE,HIGHLINE		E		'H	CTR5706R
Repair Kit, link	1.6I,1.8 GTI,1.9TDI,STD,COMFORTLINE,HIGHLINE	Control Arm Bush Rear ID17/OD60/L41	E	'E	'H	MO5414
Top Strut Mounting	1.6I,1.8 GTI,1.9TDI,STD,COMFORTLINE,HIGHLINE	Shock Mounting Front	E	'E	'H	MO6180
Tie Rod Axle Joint	1.6I,1.8 GTI,1.9TDI,STD,COMFORTLINE,HIGHLINE		E	'E	'H	RE8143

GOLF Mk V (1K1, 1K5)

10/2003 → 02/2009

Control Arm-/Trailing Arm Bush	1.4 16V, 1.4 FSI, 1.4 TSI, 1.6, 1.6 FSI, 1.9 TDI, 1.9 TDI 4motion, 2.0, 2.0 FSI, 2.0 FSI 4motion, 2.0 GTI, 2.0 SDI, 2.0 TDI, 2.0 TDI 16V, 2.0 TDI 16V 4motion, 2.0 TDI 4motion, 3.2, 3.2 R32 4motion	Material: Aluminium	E	'E		BS6883
Control Arm-/Trailing Arm Bush	1.4 16V, 1.4 FSI, 1.4 TSI, 1.6, 1.6 FSI, 1.9 TDI, 1.9 TDI 4motion, 2.0, 2.0 FSI, 2.0 FSI 4motion, 2.0 GTI, 2.0 SDI, 2.0 TDI, 2.0 TDI 16V, 2.0 TDI 16V 4motion, 2.0 TDI 4motion, 3.2, 3.2 R32 4motion	Material: Aluminium	E		'H	BS6884
Control Arm-/Trailing Arm Bush	1.4 16V, 1.4 FSI, 1.4 TSI, 1.6, 1.6 FSI, 1.6 MultiFuel, 1.8, 1.8 GTI, 1.8 Hybrid, 1.9 SDI, 1.9 TDI, 1.9 TDI 4motion, 2.0, 2.0 FSI, 2.0 FSI 4motion, 2.0 GTI, 2.0 SDI, 2.0 TDI, 2.0 TDI 16V, 2.0 TDI 16V 4motion, 2.0 TDI 4motion, 3.2, 3.2 R32 4motion	Rubber-metal Bearing	E	'E	'H	BS6899
Rod/Strut, stabiliser	1.4 16V, 1.4 FSI, 1.4 TSI, 1.6, 1.6 FSI, 1.6 MultiFuel, 1.8 GTI, 1.9 TDI, 2.0, 2.0 FSI, 2.0 GTI, 2.0 SDI, 2.0 TDI, 2.0 TDI 16V, 2.0 TDI 16V 4motion, 2.0 TDI 4motion, 3.2, 3.2 R32 4motion	Material: Steel	E	'E	'H	CTR5849
Rod/Strut, stabiliser	1.9 TDI 4motion	Engine Code: BKC; Material: Steel	E	'E	'H	CTR5849
Rod/Strut, stabiliser	2.0 FSI 4motion	Engine Code: BLY; Material: Steel	E	'E	'H	CTR5849
Rod/Strut, stabiliser	2.0 GTI	Engine Code: AXX, BWA; Material: Steel	E	'E	'H	CTR5849
Rod/Strut, stabiliser	3.2 R32 4motion	Engine Code: BUB; Material: Steel	E	'E	'H	CTR5849
Tie Rod Axle Joint	1.4 16V, 1.4 FSI, 1.4 TSI, 1.6, 1.6 FSI, 1.6 MultiFuel, 1.8, 1.8 GTI, 1.8 Hybrid, 1.9 SDI, 1.9 TDI, 1.9 TDI 4motion, 2.0, 2.0 FSI, 2.0 FSI 4motion, 2.0 GTI, 2.0 SDI, 2.0 TDI, 2.0 TDI 16V, 2.0 TDI 16V 4motion, 2.0 TDI 4motion, 3.2, 3.2 R32 4motion		E	'E	'H	RE5841

GOLF Mk VI (5K1, AJ5)

10/2008 → 11/2013

Control Arm-/Trailing Arm Bush	1.2 TSI, 1.4, 1.4 TSI, 1.6, 1.6 BiFuel, 1.6 TDI, 2.0 GTi, 2.0 R 4motion, 2.0 TDI, 2.0 TDI 4motion	Material: Aluminium	E	'E		BS6883
Control Arm-/Trailing Arm Bush	1.2 TSI, 1.4, 1.4 TSI, 1.6, 1.6 BiFuel, 1.6 TDI, 2.0 GTi, 2.0 R 4motion, 2.0 TDI, 2.0 TDI 4motion	Material: Aluminium	E		'H	BS6884
Control Arm-/Trailing Arm Bush	1.2 TSI, 1.4, 1.4 TSI, 1.6, 1.6 BiFuel, 1.6 MultiFuel, 1.6 TDI, 1.8 TSI, 2.0 GTi, 2.0 R 4motion, 2.0 TDI, 2.0 TDI 4motion	Rubber-metal Bearing	E	'E	'H	BS6899
Rod/Strut, stabiliser	1.2 TSI, 1.4, 1.4 TSI, 1.6, 1.6 BiFuel, 1.6 MultiFuel, 1.6 TDI, 1.8 TSI, 2.0 GTi, 2.0 R 4motion, 2.0 TDI, 2.0 TDI 4motion	Material: Steel	E	'E	'H	CTR5849
Tie Rod Axle Joint	1.2 TSI, 1.4, 1.4 TSI, 1.6, 1.6 BiFuel, 1.6 MultiFuel, 1.6 TDI, 1.8 TSI, 2.0 GTi, 2.0 R 4motion, 2.0 TDI, 2.0 TDI 4motion	for vehicles with electric power steering	E	'E	'H	RE5841

BS6417	BS6883	BS6884	BS6899	CJ986	CJ987	CTR5706L
Ref.Nr.: 1J0407181	Ref.Nr.: 1K0199231J	Ref.Nr.: 1K0199232J	Ref.Nr.: 1K0407182	Ref.Nr.: 1J0407365A	Ref.Nr.: 1J0407366H	Ref.Nr.: 1J0422811B
CTR5706R	CTR5849	MO5414	MO6180	RE5841	RE8143	
Ref.Nr.: 1J0422812B	Ref.Nr.: 1K0411315G	Ref.Nr.: 191407181D	Ref.Nr.: 1J0412331B	Ref.Nr.: 1K0423810A	Ref.Nr.: 1J0422807B	

Article Description			Fitting Position	Article No.
---------------------	---	---	------------------	-------------

JETTA Mk I













01/1980 → 12/1985

Track Control Arm	1.3.1.4. 1.5.1.6.1.8		E	'E	'H	CJ108
Ball Joint	1.3.1.4. 1.5.1.6.1.8	17 mm	E	'E	'H	CJ832
Tie Rod End	1.3.1.4. 1.5.1.6.1.8		E	'E	'H	CTR5140
Tie Rod Axle Joint	1.3.1.4. 1.5.1.6.1.8		E	'E	'H	RE033

JETTA Mk II (19E, 1G2, 165)

01/1984 → 07/1992

Control Arm-/Trailing Arm Bush	1.3, 1.3 CAT, 1.6, 1.6D, 1.6TD, 1.8, 1.8 16V, 1.8CAT, 1.8 Syncro		E	'E	'H	BS6911
Ball Joint	1.3, 1.3 CAT, 1.6, 1.6D, 1.6TD, 1.8, 1.8 16V, 1.8CAT, 1.8 Syncro	with fastening material; with accessories, 19 mm	E	'E	'H	CJ864
Ball Joint	1.3, 1.3 CAT, 1.6, 1.6 D, 1.6 TD, 1.8, 1.8 16V, 1.8 CAT	→ 12/1987; with accessories, 17 mm	E	'E	'H	CJ957
Tie Rod End	1.3, 1.3 CAT, 1.6, 1.6D, 1.6TD, 1.8, 1.8 16V, 1.8CAT, 1.8 Syncro		E	'E		CTR5191L
Tie Rod End	1.3, 1.3 CAT, 1.6, 1.6D, 1.6TD, 1.8, 1.8 16V, 1.8CAT, 1.8 Syncro		E		'H	CTR5191R
Repair Kit, link	1.3, 1.3 CAT, 1.6, 1.6D, 1.6TD, 1.8, 1.8 16V, 1.8CAT, 1.8 Syncro	with guide sleeve	E	'E	'H	MO5414
Tie Rod Axle Joint	1.3, 1.3 CAT, 1.6, 1.6D, 1.6TD, 1.8, 1.8 16V, 1.8CAT, 1.8 Syncro	for vehicles without power steering	E	'E	'H	RE5192
Tie Rod Axle Joint	1.3, 1.3 CAT, 1.6, 1.6D, 1.6TD, 1.8, 1.8 16V, 1.8CAT, 1.8 Syncro	for vehicles with power steering	E	'E	'H	RE5473

						
BS6911	CJ108	CJ832	CJ864	CJ957	CTR5140	CTR5191L
Ref.Nr.: 191407182	Ref.Nr.: 171407153D	Ref.Nr.: 171407365F	Ref.Nr.: 357407365	Ref.Nr.: 191407365	Ref.Nr.: 32111116463	Ref.Nr.: 3A0422811
						
CTR5191R	MO5414	RE033	RE5192	RE5473		
Ref.Nr.: 191419812	Ref.Nr.: 191407181D	Ref.Nr.: 171419821	Ref.Nr.: 191419804PAR	Ref.Nr.: 191422804APA		

Article Description			Fitting Position	Article No.
---------------------	---	---	------------------	-------------

JETTA Mk III















01/1992 → 12/1999

Control Arm-/Trailing Arm Bush	1.6 CSL,1.8 CLX,CSX,2.0 CLI 2.8 2.9 VR6	Control Arm Bush Rear ID13/OD60/L41	E	'E	'H	BS6417
Ball Joint	2.0 2.8 VR6 2.9 VR6	16,5 mm	E	'E	'H	CJ1031
Track Control Arm	1.6 CSL,1.8 CLX,CSX,2.0 CLI	Exc VR6	E	'E	'H	CJ111L
Ball Joint	1.6 CSL,1.8 CLX,CSX,2.0 CLI	19 mm Exc VR6	E	'E	'H	CJ864
Tie Rod End	1.6 CSL,1.8 CLX,CSX,2.0 CLI 2.8 2.9 VR6		E	'E		CTR5191L
Tie Rod End	1.6 CSL,1.8 CLX,CSX,2.0 CLI 2.8 2.9 VR6		E		'H	CTR5191R
Repair Kit, link	1.6 CSL,1.8 CLX,CSX,2.0 CLI 2.8 2.9 VR6	Control Arm Bush Rear ID17/OD60/L41	E	'E	'H	MO5414
Top Strut Mounting	1.6 CSL,1.8 CLX,CSX,2.0 CLI 2.8 2.9 VR6	Shock Mounting Front	E	'E	'H	MO6180
Rack End	1.6 CSL,1.8 CLX,CSX,2.0 CLI 2.8 2.9 VR6	P/S	E	'E	'H	RE5438

JETTA Mk IV

01/1999 → 12/2004

Control Arm-/Trailing Arm Bush	1.6I,1.8 GTI,1.9TDI,STD,COMFORTLINE,HIGHLINE		E	'E	'H	BS6417
Repair Kit, ball joint	1.6I,1.8 GTI,1.9TDI,STD,COMFORTLINE,HIGHLINE		E	'E		CJ986
Repair Kit, ball joint	1.6I,1.8 GTI,1.9TDI,STD,COMFORTLINE,HIGHLINE		E		'H	CJ987
Tie Rod End	1.6I,1.8 GTI,1.9TDI,STD,COMFORTLINE,HIGHLINE		E	'E		CTR5706L
Tie Rod End	1.6I,1.8 GTI,1.9TDI,STD,COMFORTLINE,HIGHLINE		E		'H	CTR5706R
Tie Rod Axle Joint	1.6I,1.8 GTI,1.9TDI,STD,COMFORTLINE,HIGHLINE		E	'E	'H	RE8143

						
BS6417	CJ1031	CJ111L	CJ864	CJ986	CJ987	CTR5191L
Ref.Nr.: 1J0407181	Ref.Nr.: 1H0407365	Ref.Nr.: 1H0407151	Ref.Nr.: 357407365	Ref.Nr.: 1J0407365A	Ref.Nr.: 1J0407366H	Ref.Nr.: 3A0422811
						
CTR5191R	CTR5706L	CTR5706R	MO5414	MO6180	RE5438	RE8143
Ref.Nr.: 191419812	Ref.Nr.: 1J0422811B	Ref.Nr.: 1J0422812B	Ref.Nr.: 191407181D	Ref.Nr.: 1J0412331B	Ref.Nr.:	Ref.Nr.: 1J0422807B

Article Description			Fitting Position	Article No.
---------------------	---	---	------------------	-------------

JETTA Mk V (1K1, 1K5)

10/2003 → 02/2009

Control Arm-/Trailing Arm Bush	1.4 16V, 1.4 FSI, 1.4 TSI, 1.6, 1.6 FSI, 1.9 TDI, 1.9 TDI 4motion, 2.0, 2.0 FSI, 2.0 FSI 4motion, 2.0 GTI, 2.0 SDI, 2.0 TDI, 2.0 TDI 16V, 2.0 TDI 16V 4motion, 2.0 TDI 4motion, 3.2, 3.2 R32 4motion	Material: Aluminium	E	E		BS6883
Control Arm-/Trailing Arm Bush	1.4 16V, 1.4 FSI, 1.4 TSI, 1.6, 1.6 FSI, 1.9 TDI, 1.9 TDI 4motion, 2.0, 2.0 FSI, 2.0 FSI 4motion, 2.0 GTI, 2.0 SDI, 2.0 TDI, 2.0 TDI 16V, 2.0 TDI 16V 4motion, 2.0 TDI 4motion, 3.2, 3.2 R32 4motion	Material: Aluminium	E		H	BS6884
Control Arm-/Trailing Arm Bush	1.4 16V, 1.4 FSI, 1.4 TSI, 1.6, 1.6 FSI, 1.6 MultiFuel, 1.8, 1.8 GTI, 1.8 Hybrid, 1.9 SDI, 1.9 TDI, 1.9 TDI 4motion, 2.0, 2.0 FSI, 2.0 FSI 4motion, 2.0 GTI, 2.0 SDI, 2.0 TDI, 2.0 TDI 16V, 2.0 TDI 16V 4motion, 2.0 TDI 4motion, 3.2, 3.2 R32 4motion	Rubber-metal Bearing	E	E	H	BS6899
Rod/Strut, stabiliser	1.4 16V, 1.4 FSI, 1.4 TSI, 1.6, 1.6 FSI, 1.6 MultiFuel, 1.8 GTI, 1.9 TDI, 2.0, 2.0 FSI, 2.0 GTI, 2.0 SDI, 2.0 TDI, 2.0 TDI 16V, 2.0 TDI 16V 4motion, 2.0 TDI 4motion, 3.2, 3.2 R32 4motion	Material: Steel	E	E	H	CTR5849
Rod/Strut, stabiliser	1.9 TDI 4motion	Engine Code: BKC; Material: Steel	E	E	H	CTR5849
Rod/Strut, stabiliser	2.0 FSI 4motion	Engine Code: BLY; Material: Steel	E	E	H	CTR5849
Rod/Strut, stabiliser	2.0 GTI	Engine Code: AXX, BWA; Material: Steel	E	E	H	CTR5849
Rod/Strut, stabiliser	3.2 R32 4motion	Engine Code: BUB; Material: Steel	E	E	H	CTR5849
Tie Rod Axle Joint	1.4 16V, 1.4 FSI, 1.4 TSI, 1.6, 1.6 FSI, 1.6 MultiFuel, 1.8, 1.8 GTI, 1.8 Hybrid, 1.9 SDI, 1.9 TDI, 1.9 TDI 4motion, 2.0, 2.0 FSI, 2.0 FSI 4motion, 2.0 GTI, 2.0 SDI, 2.0 TDI, 2.0 TDI 16V, 2.0 TDI 16V 4motion, 2.0 TDI 4motion, 3.2, 3.2 R32 4motion		E	E	H	RE5841

JETTA Mk VI (5K1, AJ5)

10/2008 → 11/2013

Control Arm-/Trailing Arm Bush	1.2 TSI, 1.4, 1.4 TSI, 1.6, 1.6 BiFuel, 1.6 TDI, 2.0 GTI, 2.0 R 4motion, 2.0 TDI, 2.0 TDI 4motion	Material: Aluminium	E	E		BS6883
Control Arm-/Trailing Arm Bush	1.2 TSI, 1.4, 1.4 TSI, 1.6, 1.6 BiFuel, 1.6 TDI, 2.0 GTI, 2.0 R 4motion, 2.0 TDI, 2.0 TDI 4motion	Material: Aluminium	E		H	BS6884
Control Arm-/Trailing Arm Bush	1.2 TSI, 1.4, 1.4 TSI, 1.6, 1.6 BiFuel, 1.6 MultiFuel, 1.6 TDI, 1.8 TSI, 2.0 GTI, 2.0 R 4motion, 2.0 TDI, 2.0 TDI 4motion	Rubber-metal Bearing	E	E	H	BS6899
Rod/Strut, stabiliser	1.2 TSI, 1.4, 1.4 TSI, 1.6, 1.6 BiFuel, 1.6 MultiFuel, 1.6 TDI, 1.8 TSI, 2.0 GTI, 2.0 R 4motion, 2.0 TDI, 2.0 TDI 4motion	Material: Steel	E	E	H	CTR5849
Tie Rod Axle Joint	1.2 TSI, 1.4, 1.4 TSI, 1.6, 1.6 BiFuel, 1.6 MultiFuel, 1.6 TDI, 1.8 TSI, 2.0 GTI, 2.0 R 4motion, 2.0 TDI, 2.0 TDI 4motion	for vehicles with electric power steering	E	E	H	RE5841

LT Mk II Bus (2DB, 2DE, 2DK)

05/1996 → 07/2006

Tie Rod End	2.3, 2.5 SDI, 2.5 TDI, 2.8 TDi		E	E	H	CTR5542
-------------	--------------------------------	--	---	---	---	---------

LT Mk II Box (2DA, 2DD, 2DH)

05/1996 → 07/2006

Tie Rod End	2.3, 2.5 SDI, 2.5 TDI, 2.8 TDI		E	E	H	CTR5542
-------------	--------------------------------	--	---	---	---	---------

LT Mk II Platform/Chassis (2DC, 2DF, 2DG, 2DL, 2DM)











06/1996 → 07/2006

Tie Rod End	2.3, 2.5 SDI, 2.5 TDI, 2.8 TDI		E	E	H	CTR5542
-------------	--------------------------------	--	---	---	---	---------

PASSAT (3A2, 35I)

02/1988 → 08/1996

Control Arm-/Trailing Arm Bush	1.6, 1.6TD, 1.8, 1.8 16V, 1.8 G60 Syncro, 1.9D, 1.9TD, 1.9 TDI, 2.0, 2.0 16V, 2.0 Syncro, 2.8 VR6		E	E	H	BS6911
Ball Joint	1.9 TDI, 2.0 16V		E	E	H	CJ1031
Ball Joint	2.8 VR6	ch.31-N-255990→; 01/1992 →	E	E	H	CJ1031
Ball Joint	1.6, 1.6TD, 1.8, 1.8 16V, 1.9D, 1.9TD, 1.9 TDI, 2.0, 2.0 16V	with fastening material; with accessories	E	E	H	CJ864
Tie Rod End	1.6, 1.6TD, 1.8, 1.8 16V, 1.8 G60 Syncro, 1.9D, 1.9TD, 1.9 TDI, 2.0, 2.0 16V, 2.0 Syncro, 2.8 VR6	ch.3A-R-0099265→	E	E		CTR5191L

						
BS6883	BS6884	BS6899	BS6911	CJ1031	CJ864	CTR5191L
Ref.Nr.: 1K0199231J	Ref.Nr.: 1K0199232J	Ref.Nr.: 1K0407182	Ref.Nr.: 191407182	Ref.Nr.: 1H0407365	Ref.Nr.: 357407365	Ref.Nr.: 3A0422811
						
CTR5542	CTR5849	RE5841				
Ref.Nr.: 2D0422811	Ref.Nr.: 1K0411315G	Ref.Nr.: 1K0423810A				

Article Description			Fitting Position	Article No.
---------------------	--	--	------------------	-------------

PASSAT (3A2, 35I)

02/1988 → 08/1996

Tie Rod End	1.6, 1.6TD, 1.8, 1.8 16V, 1.8G60Syncro, 1.9D, 1.9TD, 1.9 TDI, 2.0, 2.0 16V, 2.0 Syncro, 2.8 VR6	ch.3A-R-0099265→	E		H	CTR5191R
Repair Kit, link	1.6, 1.6TD, 1.8, 1.8 16V, 1.8G60Syncro, 1.9D, 1.9TD, 1.9 TDI, 2.0, 2.0 16V, 2.0 Syncro, 2.8 VR6	with guide sleeve	E	E	H	MO5414

PASSAT Variant (3A5, 35I)

02/1988 → 05/1997

Control Arm-/Trailing Arm Bush	1.6, 1.6TD, 1.8, 1.8 16V, 1.8G60Syncro, 1.9D, 1.9TD, 1.9 TDI, 2.0, 2.0 16V, 2.0 Syncro, 2.8 VR6, 2.9 VR6 Syncro		E	E	H	BS6911
Ball Joint	1.9 TDI, 2.0 16V, 2.9 VR6 Syncro		E	E	H	CJ1031
Ball Joint	2.8 VR6	ch.31-N-255990→; 01/1992 →	E	E	H	CJ1031
Ball Joint	1.6, 1.6TD, 1.8, 1.8 16V, 1.9D, 1.9TD, 1.9 TDI, 2.0, 2.0 16V, 2.0 Syncro	with fastening material; with accessories	E	E	H	CJ864
Ball Joint	1.8 G60 Syncro	01/1990 →; with fastening material; with accessories	E	E	H	CJ864
Tie Rod End	1.6, 1.6TD, 1.8, 1.8 16V, 1.8G60Syncro, 1.9D, 1.9TD, 1.9 TDI, 2.0, 2.0 16V, 2.0 Syncro, 2.8 VR6, 2.9 VR6 Syncro	ch.3A-R-0099265→	E	E		CTR5191L
Tie Rod End	1.6, 1.6TD, 1.8, 1.8 16V, 1.8G60Syncro, 1.9D, 1.9TD, 1.9 TDI, 2.0, 2.0 16V, 2.0 Syncro, 2.8 VR6, 2.9 VR6 Syncro	ch.3A-R-0099265→	E		H	CTR5191R
Repair Kit, link	1.6, 1.6TD, 1.8, 1.8 16V, 1.8G60Syncro, 1.9D, 1.9TD, 1.9 TDI, 2.0, 2.0 16V, 2.0 Syncro, 2.8 VR6, 2.9 VR6 Syncro	with guide sleeve	E	E	H	MO5414

PASSAT (3B2)

08/1996 → 12/2001

Control Arm-/Trailing Arm Bush	1.6, 1.8, 1.8 Syncro/4motion, 1.8 T, 1.9 TDI, 1.9 TDI 4motion, 1.9 TDI Syncro/4motion, 2.0, 2.0 4motion, 2.3 VR5, 2.3 VR5 Syncro/4motion, 2.5 TDI, 2.5 TDI Syncro/4motion, 2.8 V6, 2.8 V6 Syncro/4motion		E	E	H	BS6911
Control Arm-/Trailing Arm Bush	1.6, 1.8, 1.8 Syncro/4motion, 1.8 T, 1.9 TDI, 1.9 TDI Syncro/4motion, 2.3 VR5, 2.3 VR5 Syncro/4motion, 2.5 TDI, 2.8 V6, 2.8 V6 Syncro/4motion	Rubber-metal Bearing; 01/1997 →	E	E	H	BS7069
Control Arm-/Trailing Arm Bush	1.6, 1.8, 1.8 Syncro/4motion, 1.8 T, 1.9 TDI, 1.9 TDI Syncro/4motion, 2.3 VR5, 2.3 VR5 Syncro/4motion, 2.5 TDI, 2.8 V6, 2.8 V6 Syncro/4motion	01/1997 →	E	E	H	BS7072
Control Arm-/Trailing Arm Bush	1.9 TDI 4motion	ch.→3B-VP-102593	E	E	H	BS7072
Control Arm-/Trailing Arm Bush	2.5 TDI Syncro/4motion	for OE: 8D0407505B	E	E	H	BS7072
Track Control Arm	1.6, 1.8, 1.8 Syncro/4motion, 1.8 T, 1.9 TDI, 1.9 TDI 4motion, 1.9 TDI Syncro/4motion, 2.3 VR5, 2.3 VR5 Syncro/4motion, 2.5 TDI, 2.5 TDI Syncro/4motion, 2.8 V6, 2.8 V6 Syncro/4motion		E		H	CJ1033
Track Control Arm	1.6, 1.8, 1.8 Syncro/4motion, 1.8 T, 1.9 TDI, 1.9 TDI 4motion, 1.9 TDI Syncro/4motion, 2.3 VR5, 2.3 VR5 Syncro/4motion, 2.5 TDI, 2.5 TDI Syncro/4motion, 2.8 V6, 2.8 V6 Syncro/4motion		E	E		CJ1034
Track Control Arm	1.6, 1.8, 1.8 Syncro/4motion, 1.8 T, 1.9 TDI, 1.9 TDI 4motion, 1.9 TDI Syncro/4motion, 2.3 VR5, 2.3 VR5 Syncro/4motion, 2.5 TDI, 2.5 TDI Syncro/4motion, 2.8 V6, 2.8 V6 Syncro/4motion		E		H	CJ1035
Track Control Arm	1.6, 1.8, 1.8 Syncro/4motion, 1.8 T, 1.9 TDI, 1.9 TDI 4motion, 1.9 TDI Syncro/4motion, 2.3 VR5, 2.3 VR5 Syncro/4motion, 2.5 TDI, 2.5 TDI Syncro/4motion, 2.8 V6, 2.8 V6 Syncro/4motion		E	E		CJ287
Track Control Arm	1.6, 1.8, 1.8 Syncro/4motion, 1.8 T, 1.8 T Syncro, 1.9 TDI, 1.9 TDI 4motion, 1.9 TDI Syncro/4motion, 2.0, 2.0 4motion, 2.3 VR5, 2.3 VR5 Syncro/4motion, 2.5 TDI, 2.5 TDI Syncro/4motion, 2.8 Syncro, 2.8 V6, 2.8 V6 Syncro/4motion		E	E		CJ292

BS6911	BS7069	BS7072	CJ1031	CJ1033	CJ1034	CJ1035
Ref.Nr.: 191407182	Ref.Nr.: 4D0407183P	Ref.Nr.: 4D0407515	Ref.Nr.: 1H0407365	Ref.Nr.: 8D0407506H	Ref.Nr.: 4D0407509K	Ref.Nr.: 4D0407510B
CJ287	CJ292	CJ864	CTR5191L	CTR5191R	MO5414	
Ref.Nr.: 8D0407505B	Ref.Nr.: 4D0407693E	Ref.Nr.: 357407365	Ref.Nr.: 3A0422811	Ref.Nr.: 191419812	Ref.Nr.: 191407181D	

Article Description			Fitting Position	Article No.
---------------------	---	---	------------------	-------------

PASSAT (3B2)

08/1996 → 12/2001

Track Control Arm	1.6, 1.8, 1.8 Syncro/4motion, 1.8 T, 1.8 T Syncro, 1.9 TDI, 1.9 TDI 4motion, 1.9 TDI Syncro/4motion, 2.0, 2.0 4motion, 2.3 VR5, 2.3 VR5 Syncro/4motion, 2.5 TDI, 2.5 TDI Syncro/4motion, 2.8 Syncro, 2.8 V6, 2.8 V6 Syncro/4motion		E		H	CJ293
Tie Rod End	1.6, 1.8, 1.8 Syncro/4motion, 1.8 T, 1.8 T Syncro, 1.9 TDI, 1.9 TDI 4motion, 1.9 TDI Syncro/4motion, 2.0, 2.0 4motion, 2.3 VR5, 2.3 VR5 Syncro/4motion, 2.5 TDI, 2.5 TDI Syncro/4motion, 2.8 Syncro, 2.8 V6, 2.8 V6 Syncro/4motion	with screw	E	E	H	CTR5491

PASSAT Estate (3B5)











05/1997 → 12/2001

Control Arm-/Trailing Arm Bush	1.6, 1.8, 1.8 Syncro/4motion, 1.8 T, 1.9 TDI, 1.9 TDI 4motion, 1.9 TDI Syncro/4motion, 2.0, 2.0 4motion, 2.3 VR5, 2.3 VR5 Syncro/4motion, 2.5 TDI, 2.5 TDI Syncro/4motion, 2.8 V6, 2.8 V6 Syncro/4motion		E	E	H	BS6911
Control Arm-/Trailing Arm Bush	1.6, 1.8, 1.8 Syncro/4motion, 1.8 T, 1.9 TDI, 1.9 TDI Syncro/4motion, 2.3 VR5, 2.3 VR5 Syncro/4motion, 2.5 TDI, 2.8 V6, 2.8 V6 Syncro/4motion	Rubber-metal Bearing	E	E	H	BS7069
Control Arm-/Trailing Arm Bush	1.6, 1.8, 1.8 Syncro/4motion, 1.8 T, 1.9 TDI, 1.9 TDI Syncro/4motion, 2.3 VR5, 2.3 VR5 Syncro/4motion, 2.5 TDI, 2.8 V6, 2.8 V6 Syncro/4motion		E	E	H	BS7072
Control Arm-/Trailing Arm Bush	1.9 TDI 4motion, 2.5 TDI Syncro/4motion	for OE: 8D0407505B	E	E	H	BS7072
Track Control Arm	1.6, 1.8, 1.8 Syncro/4motion, 1.8 T, 1.9 TDI, 1.9 TDI 4motion, 1.9 TDI Syncro/4motion, 2.3 VR5, 2.3 VR5 Syncro/4motion, 2.5 TDI, 2.5 TDI Syncro/4motion, 2.8 V6, 2.8 V6 Syncro/4motion		E		H	CJ1033
Track Control Arm	1.6, 1.8, 1.8 Syncro/4motion, 1.8 T, 1.9 TDI, 1.9 TDI 4motion, 1.9 TDI Syncro/4motion, 2.3 VR5, 2.3 VR5 Syncro/4motion, 2.5 TDI, 2.5 TDI Syncro/4motion, 2.8 V6, 2.8 V6 Syncro/4motion		E	E		CJ1034
Track Control Arm	1.6, 1.8, 1.8 Syncro/4motion, 1.8 T, 1.9 TDI, 1.9 TDI 4motion, 1.9 TDI Syncro/4motion, 2.3 VR5, 2.3 VR5 Syncro/4motion, 2.5 TDI, 2.5 TDI Syncro/4motion, 2.8 V6, 2.8 V6 Syncro/4motion		E		H	CJ1035
Track Control Arm	1.6, 1.8, 1.8 Syncro/4motion, 1.8 T, 1.9 TDI, 1.9 TDI 4motion, 1.9 TDI Syncro/4motion, 2.3 VR5, 2.3 VR5 Syncro/4motion, 2.5 TDI, 2.5 TDI Syncro/4motion, 2.8 V6, 2.8 V6 Syncro/4motion		E	E		CJ287
Track Control Arm	1.6, 1.8, 1.8 Syncro/4motion, 1.8 T, 1.9 TDI, 1.9 TDI 4motion, 1.9 TDI Syncro/4motion, 2.0, 2.0 4motion, 2.3 VR5, 2.3 VR5 Syncro/4motion, 2.5 TDI, 2.5 TDI Syncro/4motion, 2.8 Syncro, 2.8 V6, 2.8 V6 Syncro/4motion		E	E		CJ292
Track Control Arm	1.6, 1.8, 1.8 Syncro/4motion, 1.8 T, 1.9 TDI, 1.9 TDI 4motion, 1.9 TDI Syncro/4motion, 2.0, 2.0 4motion, 2.3 VR5, 2.3 VR5 Syncro/4motion, 2.5 TDI, 2.5 TDI Syncro/4motion, 2.8 Syncro, 2.8 V6, 2.8 V6 Syncro/4motion		E		H	CJ293
Tie Rod End	1.6, 1.8, 1.8 Syncro/4motion, 1.8 T, 1.9 TDI, 1.9 TDI 4motion, 1.9 TDI Syncro/4motion, 2.0, 2.0 4motion, 2.3 VR5, 2.3 VR5 Syncro/4motion, 2.5 TDI, 2.5 TDI Syncro/4motion, 2.8 Syncro, 2.8 V6, 2.8 V6 Syncro/4motion	with screw	E	E	H	CTR5491

PASSAT (3B3)

11/2000 → 05/2005

Control Arm-/Trailing Arm Bush	1.6, 1.9 TDI, 2.0, 2.3 V5	for OE: 8D0407505B	E	E	H	BS7072
Track Control Arm	1.6, 1.9 TDI, 2.0, 2.3 V5		E		H	CJ1033
Track Control Arm	1.6, 1.8 T 20V, 1.9 TDI, 1.9 TDI 4motion, 2.0, 2.0 4motion, 2.3 V5, 2.3 V5 4motion, 2.5 TDI, 2.5 TDI 4motion, 2.8 4motion		E	E		CJ1034
Track Control Arm	1.6, 1.8 T 20V, 1.9 TDI, 1.9 TDI 4motion, 2.0, 2.0 4motion, 2.3 V5, 2.3 V5 4motion, 2.5 TDI, 2.5 TDI 4motion, 2.8 4motion		E		H	CJ1035

						
BS6911	BS7069	BS7072	CJ1033	CJ1034	CJ1035	CJ287
Ref.Nr.: 191407182	Ref.Nr.: 4D0407183P	Ref.Nr.: 4D0407515	Ref.Nr.: 8D0407506H	Ref.Nr.: 4D0407509K	Ref.Nr.: 4D0407510B	Ref.Nr.: 8D0407505B
						
CJ292	CJ293	CTR5491				
Ref.Nr.: 4D0407693E	Ref.Nr.: 4D0407694K	Ref.Nr.: 4B0419811B				

Article Description			Fitting Position	Article No.
---------------------	--	--	------------------	-------------

PASSAT (3B3)

11/2000 → 05/2005

Track Control Arm	1.6, 1.9 TDI, 2.0, 2.3 V5		E	'E		CJ287
Track Control Arm	1.6, 1.8, 1.8 T, 1.8 T 20V, 1.8 T 4motion, 1.9 TDI, 1.9 TDI 4motion, 2.0, 2.0 4motion, 2.0 TDI, 2.3 V5, 2.3 V5 4motion, 2.5 TDI, 2.5 TDI 4motion, 2.8 4motion, 4.0 W8 4motion		E	'E		CJ292
Track Control Arm	1.6, 1.8, 1.8 T, 1.8 T 20V, 1.8 T 4motion, 1.9 TDI, 1.9 TDI 4motion, 2.0, 2.0 4motion, 2.0 TDI, 2.3 V5, 2.3 V5 4motion, 2.5 TDI, 2.5 TDI 4motion, 2.8 4motion, 4.0 W8 4motion		E		'H	CJ293
Tie Rod End	1.6, 1.8, 1.8 T, 1.8 T 20V, 1.8 T 4motion, 1.9 TDI, 1.9 TDI 4motion, 2.0, 2.0 4motion, 2.0 TDI, 2.3 V5, 2.3 V5 4motion, 2.5 TDI, 2.5 TDI 4motion, 2.8 4motion, 4.0 W8 4motion	with screw	E	'E	'H	CTR5491

PASSAT Variant (3B6)

11/2000 → 08/2005

Control Arm-/Trailing Arm Bush	1.6, 1.9 TDI, 2.0, 2.3 VR5	for OE: 8D0407505B	E	'E	'H	BS7072
Track Control Arm	1.6, 1.9 TDI, 2.0, 2.3 VR5		E		'H	CJ1033
Track Control Arm	1.6, 1.8 T 20V, 1.9 TDI, 1.9 TDI 4motion, 2.0, 2.0 4motion, 2.3 VR5, 2.3 VR5 4motion, 2.5 TDI, 2.5 TDI 4motion, 2.8 4motion		E	'E		CJ1034
Track Control Arm	1.6, 1.8 T 20V, 1.9 TDI, 1.9 TDI 4motion, 2.0, 2.0 4motion, 2.3 VR5, 2.3 VR5 4motion, 2.5 TDI, 2.5 TDI 4motion, 2.8 4motion		E		'H	CJ1035
Track Control Arm	1.6, 1.9 TDI, 2.0, 2.3 VR5	for OE: 8D0407505B	E	'E		CJ287
Track Control Arm	1.6, 1.8 4motion, 1.8 T, 1.8 T 20V, 1.9 TDI, 1.9 TDI 4motion, 2.0, 2.0 4motion, 2.0 TDI, 2.3 VR5, 2.3 VR5 4motion, 2.5 TDI, 2.5 TDI 4motion, 2.8 4motion, 4.0 W8 4motion		E	'E		CJ292
Track Control Arm	1.6, 1.8 4motion, 1.8 T, 1.8 T 20V, 1.9 TDI, 1.9 TDI 4motion, 2.0, 2.0 4motion, 2.0 TDI, 2.3 VR5, 2.3 VR5 4motion, 2.5 TDI, 2.5 TDI 4motion, 2.8 4motion, 4.0 W8 4motion		E		'H	CJ293
Tie Rod End	1.6, 1.8 4motion, 1.8 T, 1.8 T 20V, 1.9 TDI, 1.9 TDI 4motion, 2.0, 2.0 4motion, 2.0 TDI, 2.3 VR5, 2.3 VR5 4motion, 2.5 TDI, 2.5 TDI 4motion, 2.8 4motion, 4.0 W8 4motion	with screw	E	'E	'H	CTR5491

PASSAT (3C2)

03/2005 → 11/2010

Control Arm-/Trailing Arm Bush	1.4 TSI, 1.4 TSI EcoFuel, 1.6, 1.6 FSI, 1.6 TDI, 1.8 TSI, 1.9 TDI, 2.0 BlueTDI, 2.0 FSI, 2.0 FSI 4motion, 2.0 TDI, 2.0 TDI 16V, 2.0 TDI 16V 4motion, 2.0 TDI 4motion, 3.2 FSI 4motion, 3.6 R36 4motion	Rubber-metal Bearing	E	'E	'H	BS6899
Rod/Strut, stabiliser	1.4 TSI, 1.4 TSI EcoFuel, 1.6, 1.6 FSI, 1.6 TDI, 1.8 TSI, 2.0 BlueTDI, 2.0 FSI, 2.0 TDI, 2.0 TDI 4motion, 3.2 FSI 4motion, 3.6 R36 4motion	Material: Steel	E	'E	'H	CTR5849
Rod/Strut, stabiliser	1.9 TDI	Engine Code: BKC; Material: Steel	E	'E	'H	CTR5849
Rod/Strut, stabiliser	2.0 FSI	Engine Code: AXG; Material: Steel	E	'E	'H	CTR5849
Rod/Strut, stabiliser	2.0 FSI	Engine Code: BLR, BLY; Material: Steel	E	'E	'H	CTR5849
Rod/Strut, stabiliser	2.0 FSI 4motion	Engine Code: BVX; Material: Steel	E	'E	'H	CTR5849
Rod/Strut, stabiliser	2.0 TDI 16V, 2.0 TDI 16V 4motion	Engine Code: BKP; Material: Steel	E	'E	'H	CTR5849
Tie Rod Axle Joint	1.4 TSI, 1.4 TSI EcoFuel, 1.6, 1.6 FSI, 1.6 TDI, 1.8 TSI, 1.9 TDI, 2.0 BlueTDI, 2.0 FSI, 2.0 FSI 4motion, 2.0 TDI, 2.0 TDI 16V, 2.0 TDI 16V 4motion, 2.0 TDI 4motion, 3.2 FSI 4motion, 3.6 R36 4motion		E	'E	'H	RE5841

PASSAT Variant (3C5)

08/2005 → 10/2011

Control Arm-/Trailing Arm Bush	1.4 TSI, 1.4 TSI EcoFuel, 1.6, 1.6 FSI, 1.6 TDI, 1.8 TSI, 1.9 TDI, 2.0 BlueTDI, 2.0 FSI, 2.0 FSI 4motion, 2.0 TDI, 2.0 TDI 16V, 2.0 TDI 16V 4motion, 2.0 TDI 4motion, 3.2 FSI 4motion, 3.6 R36 4motion	Rubber-metal Bearing	E	'E	'H	BS6899
--------------------------------	--	----------------------	---	----	----	--------

BS6899	BS7072	CJ1033	CJ1034	CJ1035	CJ287	CJ292
Ref.Nr.: 1K0407182	Ref.Nr.: 4D0407515	Ref.Nr.: 8D0407506H	Ref.Nr.: 4D0407509K	Ref.Nr.: 4D0407510B	Ref.Nr.: 8D0407505B	Ref.Nr.: 4D0407693E
CJ293	CTR5491	CTR5849	RE5841			
Ref.Nr.: 4D0407694K	Ref.Nr.: 4B0419811B	Ref.Nr.: 1K0411315G	Ref.Nr.: 1K0423810A			

Article Description			Fitting Position	Article No.
---------------------	---	---	------------------	-------------

PASSAT Variant (3C5)

08/2005 → 10/2011

Rod/Strut, stabiliser	1.4 TSI, 1.4 TSI EcoFuel, 1.6, 1.6 FSI, 1.6 TDI, 1.8 TSI, 2.0 Blue TDI, 2.0 FSI, 2.0 TDI, 2.0 TDI 16V 4motion, 2.0 TDI 4motion, 3.2 FSI 4motion, 3.6 R36 4motion	Material: Steel	E	E	H	CTR5849
Rod/Strut, stabiliser	1.9 TDI	Engine Code: BKC, BLS; Material: Steel	E	E	H	CTR5849
Rod/Strut, stabiliser	2.0 FSI	Engine Code: AXG; Material: Steel	E	E	H	CTR5849
Rod/Strut, stabiliser	2.0 FSI	Engine Code: BLR, BLY; Material: Steel	E	E	H	CTR5849
Rod/Strut, stabiliser	2.0 FSI 4motion	Engine Code: BVX; Material: Steel	E	E	H	CTR5849
Rod/Strut, stabiliser	2.0 TDI	Engine Code: BMA; Material: Steel	E	E	H	CTR5849
Rod/Strut, stabiliser	2.0 TDI	Engine Code: BVE; Material: Steel	E	E	H	CTR5849
Rod/Strut, stabiliser	2.0 TDI 16V	Engine Code: BKP; Material: Steel	E	E	H	CTR5849
Tie Rod Axle Joint	1.4 TSI, 1.4 TSI EcoFuel, 1.6, 1.6 FSI, 1.6 TDI, 1.8 TSI, 1.9 TDI, 2.0 Blue TDI, 2.0 FSI, 2.0 FSI 4motion, 2.0 TDI, 2.0 TDI 16V, 2.0 TDI 16V 4motion, 2.0 TDI 4motion, 3.2 FSI 4motion, 3.6 R36 4motion		E	E	H	RE5841

PASSAT CC (357)

05/2008 → 01/2012

Control Arm-/Trailing Arm Bush	1.4 TSI MultiFuel, 1.8 TSI, 2.0 Blue TDI, 2.0 TDI, 2.0 TDI 4motion, 2.0 TSI, 3.6 FSI 4motion	Rubber-metal Bearing	E	E	H	BS6899
Rod/Strut, stabiliser	1.8 TSI, 2.0 Blue TDI, 2.0 TDI, 2.0 TDI 4motion, 2.0 TSI, 3.6 FSI 4motion	Material: Steel	E	E	H	CTR5849
Tie Rod Axle Joint	1.8 TSI, 2.0 Blue TDI, 2.0 TDI, 2.0 TDI 4motion, 2.0 TSI, 3.6 FSI 4motion	for vehicles with electric power steering	E	E	H	RE5841

PASSAT (362)

08/2010 → 12/2014

Control Arm-/Trailing Arm Bush	1.4 TSI, 1.4 TSI EcoFuel, 1.4 TSI MultiFuel, 1.6 TDI, 1.8 TSI, 2.0 TDI, 2.0 TDI 4motion, 2.0 TSI, 3.6 FSI 4motion	Rubber-metal Bearing	E	E	H	BS6899
Rod/Strut, stabiliser	1.4 TSI, 1.4 TSI EcoFuel, 1.4 TSI MultiFuel, 1.6 TDI, 1.8 TSI, 2.0 TDI, 2.0 TDI 4motion, 2.0 TSI, 3.6 FSI 4motion	Material: Steel	E	E	H	CTR5849
Tie Rod Axle Joint	1.4 TSI, 1.4 TSI EcoFuel, 1.4 TSI MultiFuel, 1.6 TDI, 1.8 TSI, 2.0 TDI, 2.0 TDI 4motion, 2.0 TSI, 3.6 FSI 4motion		E	E	H	RE5841

PASSAT Variant (365)

08/2010 → 12/2014

Control Arm-/Trailing Arm Bush	1.4 TSI, 1.4 TSI EcoFuel, 1.4 TSI MultiFuel, 1.6 TDI, 1.8 TSI, 2.0 TDI, 2.0 TDI 4motion, 2.0 TSI, 3.6 FSI 4motion	Rubber-metal Bearing	E	E	H	BS6899
Rod/Strut, stabiliser	1.4 TSI, 1.4 TSI EcoFuel, 1.4 TSI MultiFuel, 1.6 TDI, 1.8 TSI, 2.0 TDI, 2.0 TDI 4motion, 2.0 TSI, 3.6 FSI 4motion	Material: Steel	E	E	H	CTR5849
Tie Rod Axle Joint	1.4 TSI, 1.4 TSI EcoFuel, 1.4 TSI MultiFuel, 1.6 TDI, 1.8 TSI, 2.0 TDI, 2.0 TDI 4motion, 2.0 TSI, 3.6 FSI 4motion		E	E	H	RE5841

PASSAT ALLTRACK (365)

01/2012 → 12/2014

Control Arm-/Trailing Arm Bush	2.0 TSI 4motion	Rubber-metal Bearing	E	E	H	BS6899
Rod/Strut, stabiliser	2.0 TSI 4motion	Material: Steel	E	E	H	CTR5849

POLO Mk I

01/1996 → 12/2003

Control Arm-/Trailing Arm Bush	1.4I, 1.6I, 1.8I, 2.0I CLASSIC, PLAYA	Control Arm Bush Front OD33.5 mm	E	E	H	BS6911
Ball Joint	1.4I, 1.6I, 1.8I, 2.0I CLASSIC, PLAYA	19 mm	E	E	H	CJ864
Tie Rod End	1.4I, 1.6I, 1.8I, 2.0I CLASSIC, PLAYA		E	E		CTR5191L
Tie Rod End	1.4I, 1.6I, 1.8I, 2.0I CLASSIC, PLAYA		E		H	CTR5191R
Repair Kit, link	1.4I, 1.6I, 1.8I, 2.0I CLASSIC, PLAYA	Control Arm Bush Rear ID17/OD60/L41	E	E	H	MO5414
Top Strut Mounting	1.4I, 1.6I, 1.8I, 2.0I CLASSIC, PLAYA	Shock Mounting Front	E	E	H	MO6180

						
BS6899	BS6911	CJ864	CTR5191L	CTR5191R	CTR5849	MO5414
Ref.Nr.: 1K0407182	Ref.Nr.: 191407182	Ref.Nr.: 357407365	Ref.Nr.: 3A0422811	Ref.Nr.: 191419812	Ref.Nr.: 1K0411315G	Ref.Nr.: 191407181D
						
MO6180	RE5841					
Ref.Nr.: 1J0412331B	Ref.Nr.: 1K0423810A					

Article Description			Fitting Position	Article No.
---------------------	---	---	------------------	-------------

POLO Mk I









01/1996 → 12/2003

Rack End	1.4I,1.6I,1.8I,2.0I CLASSIC,PLAYA	P/S Long	E	'E	'H	RE5512
Rack End	1.4I,1.6I,1.8I,2.0I CLASSIC,PLAYA	M/S Short	E	'E	'H	RE5712

POLO Mk II

01/2003 → 12/2010

Ball Joint	1.4,1.6,1.8,1.9TDI,2.0 CLASIC,TRENDLINE,COMFORTLINE,HIGHLINE		E		'H	CJ1090
Ball Joint	1.4,1.6,1.8,1.9TDI,2.0 CLASIC,TRENDLINE,COMFORTLINE,HIGHLINE		E	'E		CJ1091
Track Control Arm	1.4,1.6,1.8,1.9TDI,2.0 CLASIC,TRENDLINE,COMFORTLINE,HIGHLINE		E	'E	'H	CJ205L
Rod/Strut, stabiliser	1.4,1.6,1.8,1.9TDI,2.0 CLASIC,TRENDLINE,COMFORTLINE,HIGHLINE		E	'E	'H	CTR5605
Tie Rod End	1.4,1.6,1.8,1.9TDI,2.0 CLASIC,TRENDLINE,COMFORTLINE,HIGHLINE		E	'E		CTR5706L
Tie Rod End	1.4,1.6,1.8,1.9TDI,2.0 CLASIC,TRENDLINE,COMFORTLINE,HIGHLINE		E		'H	CTR5706R
Tie Rod End	1.4,1.6,1.8,1.9TDI,2.0 CLASIC,TRENDLINE,COMFORTLINE,HIGHLINE		E	'E		CTR5834L
Tie Rod End	1.4,1.6,1.8,1.9TDI,2.0 CLASIC,TRENDLINE,COMFORTLINE,HIGHLINE		E		'H	CTR5834R
Tie Rod Axle Joint	1.4,1.6,1.8,1.9TDI,2.0 CLASIC,TRENDLINE,COMFORTLINE,HIGHLINE	M/S	E	'E	'H	RE0185
Rack End	1.4,1.6,1.8,1.9TDI,2.0 CLASIC,TRENDLINE,COMFORTLINE,HIGHLINE	M/S Short	E	'E	'H	RE5712
Tie Rod Axle Joint	1.4,1.6,1.8,1.9TDI,2.0 CLASIC,TRENDLINE,COMFORTLINE,HIGHLINE	P/S Long	E	'E	'H	RE5870

						
CJ1090	CJ1091	CJ205L	CTR5605	CTR5706L	CTR5706R	CTR5834L
Ref.Nr.: 6Q0407365M	Ref.Nr.: 6Q0407366M	Ref.Nr.: 6Q0407151L	Ref.Nr.: 6Q0411315E	Ref.Nr.: 1J0422811B	Ref.Nr.: 1J0422812B	Ref.Nr.: 6Q0423811A
						
CTR5834R	RE0185	RE5512	RE5712	RE5870		
Ref.Nr.: 6Q0423812	Ref.Nr.: 6X0422804A	Ref.Nr.:	Ref.Nr.: 6Q0423803PPA	Ref.Nr.: 6Q0423804EPA		

Article Description			Fitting Position	Article No.
---------------------	---	---	------------------	-------------

POLO Mk III /VIVO











01/2010 →

Ball Joint	1.4,1.6, TRENDLINE,HATCH & SEDAN		E		H	CJ1090
Ball Joint	1.4,1.6, TRENDLINE,HATCH & SEDAN		E	E		CJ1091
Rod/Strut, stabiliser	1.4,1.6, TRENDLINE,HATCH & SEDAN		E	E	H	CTR5605
Tie Rod End	1.4,1.6, TRENDLINE,HATCH & SEDAN		E	E		CTR5706L
Tie Rod End	1.4,1.6, TRENDLINE,HATCH & SEDAN		E		H	CTR5706R
Tie Rod End	1.4,1.6, TRENDLINE,HATCH & SEDAN		E	E		CTR5834L
Tie Rod End	1.4,1.6, TRENDLINE,HATCH & SEDAN		E		H	CTR5834R
Tie Rod Axle Joint	1.4,1.6, TRENDLINE,HATCH & SEDAN	M/S	E	E	H	RE0185
Rack End	1.4,1.6, TRENDLINE,HATCH & SEDAN	M/S Short	E	E	H	RE5712
Tie Rod Axle Joint	1.4,1.6, TRENDLINE,HATCH & SEDAN	P/S Long	E	E	H	RE5870

POLO Mk V 6R,6C

01/2010 →

Rod/Strut, stabiliser	1.2,1.2TDI,1.2TSL,1.4,1.4GTI,1.4TSL,1.6,1.6TDI		E	E	H	CTR5605
Tie Rod End	1.2,1.2TDI,1.2TSL,1.4,1.4GTI,1.4TSL,1.6,1.6TDI		E	E		CTR5834L
Tie Rod End	1.2,1.2TDI,1.2TSL,1.4,1.4GTI,1.4TSL,1.6,1.6TDI		E		H	CTR5834R
Top Strut Mounting	1.2,1.2TDI,1.2TSL,1.4,1.4GTI,1.4TSL,1.6,1.6TDI		E	E	H	MO6180

						
CJ1090	CJ1091	CTR5605	CTR5706L	CTR5706R	CTR5834L	CTR5834R
Ref.Nr.: 6Q0407365M	Ref.Nr.: 6Q0407366M	Ref.Nr.: 6Q0411315E	Ref.Nr.: 1J0422811B	Ref.Nr.: 1J0422812B	Ref.Nr.: 6Q0423811A	Ref.Nr.: 6Q0423812
						
MO6180	RE0185	RE5712	RE5870			
Ref.Nr.: 1J0412331B	Ref.Nr.: 6X0422804A	Ref.Nr.: 6Q0423803PPA	Ref.Nr.: 6Q0423804EPA			

Article Description			Fitting Position	Article No.
---------------------	--	--	------------------	-------------

SCIROCCO (53)

02/1974 → 07/1980

Control Arm-/Trailing Arm Bush	1.1, 1.3, 1.5, 1.6		E	'E	'H	BS6911
Track Control Arm	1.1, 1.3, 1.5, 1.6	with rubber mounting, without ball joint	E	'E	'H	CJ108
Ball Joint	1.1, 1.3, 1.5, 1.6	ch.178-3-173 584→	E	'E	'H	CJ832
Tie Rod End	1.1, 1.3, 1.5, 1.6		E	'E	'H	CTR5140
Tie Rod Axle Joint	1.1, 1.3, 1.5, 1.6		E	'E	'H	RE033

SCIROCCO (53B)

08/1980 → 07/1992

Control Arm-/Trailing Arm Bush	1.3, 1.5, 1.6, 1.8, 1.8 16V		E	'E	'H	BS6911
Track Control Arm	1.3, 1.5, 1.6, 1.8, 1.8 16V	with rubber mounting, without ball joint	E	'E	'H	CJ108
Ball Joint	1.3, 1.5, 1.6, 1.8, 1.8 16V	ch.178-3-173 584→	E	'E	'H	CJ832
Tie Rod End	1.3, 1.5, 1.6, 1.8, 1.8 16V		E	'E	'H	CTR5140
Tie Rod Axle Joint	1.3, 1.5, 1.6, 1.8, 1.8 16V		E	'E	'H	RE033

SCIROCCO (137, 138)

05/2008 → 11/2009

Control Arm-/Trailing Arm Bush	1.4 TSI, 2.0 R, 2.0 TDI, 2.0 TSI	Material: Aluminium	E	'E		BS6883
Control Arm-/Trailing Arm Bush	1.4 TSI, 2.0 R, 2.0 TDI, 2.0 TSI	Material: Aluminium	E		'H	BS6884
Control Arm-/Trailing Arm Bush	1.4 TSI, 2.0 R, 2.0 TDI, 2.0 TSI	Rubber-metal Bearing	E	'E	'H	BS6899
Rod/Strut, stabiliser	1.4 TSI, 2.0 R, 2.0 TDI, 2.0 TSI	Material: Steel	E	'E	'H	CTR5849
Tie Rod Axle Joint	1.4 TSI, 2.0 R, 2.0 TDI, 2.0 TSI	for vehicles with electric power steering	E	'E	'H	RE5841

SHARAN (7N1, 7N2)

05/2010 → 05/2012

Control Arm-/Trailing Arm Bush	1.4 TSI, 2.0 TDI, 2.0 TDI 4motion, 2.0 TSI	Rubber-metal Bearing	E	'E	'H	BS6899
Tie Rod Axle Joint	1.4 TSI, 2.0 TDI, 2.0 TSI	for vehicles with electric power steering	E	'E	'H	RE5841

TIGUAN (5N_)

09/2007 → 08/2009

Control Arm-/Trailing Arm Bush	1.4 TSI, 1.4 TSI 4motion, 2.0 TDI, 2.0 TDI 4motion, 2.0 TFSI 4motion, 2.0 TSI 4motion	Rubber-metal Bearing	E	'E	'H	BS6899
Rod/Strut, stabiliser	1.4 TSI, 1.4 TSI 4motion, 2.0 TDI, 2.0 TDI 4motion, 2.0 TFSI 4motion	Material: Steel	E	'E	'H	CTR5849
Tie Rod Axle Joint	1.4 TSI, 1.4 TSI 4motion, 2.0 TDI, 2.0 TDI 4motion, 2.0 TFSI 4motion		E	'E	'H	RE5841

BS6883	BS6884	BS6899	BS6911	CJ108	CJ832	CTR5140
Ref.Nr.: 1K0199231J	Ref.Nr.: 1K0199232J	Ref.Nr.: 1K0407182	Ref.Nr.: 191407182	Ref.Nr.: 171407153D	Ref.Nr.: 171407365F	Ref.Nr.: 32111116463
CTR5849	RE033	RE5841				
Ref.Nr.: 1K0411315G	Ref.Nr.: 171419821	Ref.Nr.: 1K0423810A				

Article Description			Fitting Position	Article No.
---------------------	---	---	------------------	-------------

TOURAN (1T1, 1T2)

02/2003 → 05/2010

Control Arm-/Trailing Arm Bush	1.4FSI, 1.4TSI, 1.4TSIEcoFuel, 1.6, 1.6FSI, 1.9TDI, 2.0 EcoFuel, 2.0 FSI, 2.0 TDI, 2.0 TDI 16V	Material: Aluminium	E	'E		BS6883
Control Arm-/Trailing Arm Bush	1.4FSI, 1.4TSI, 1.4TSIEcoFuel, 1.6, 1.6FSI, 1.9TDI, 2.0 EcoFuel, 2.0 FSI, 2.0 TDI, 2.0 TDI 16V	Material: Aluminium	E		'H	BS6884
Control Arm-/Trailing Arm Bush	1.4FSI, 1.4TSI, 1.4TSIEcoFuel, 1.6, 1.6FSI, 1.9TDI, 2.0 EcoFuel, 2.0 FSI, 2.0 TDI, 2.0 TDI 16V	Rubber-metal Bearing	E	'E	'H	BS6899
Rod/Strut, stabiliser	1.4FSI, 1.4TSI, 1.4TSIEcoFuel, 1.6, 1.6FSI, 1.9TDI, 2.0 EcoFuel, 2.0 FSI, 2.0 TDI, 2.0 TDI 16V	Material: Steel	E	'E	'H	CTR5849
Rod/Strut, stabiliser	1.9 TDI	Engine Code: BRU; Material: Steel	E	'E	'H	CTR5849
Tie Rod Axle Joint	1.4FSI, 1.4TSI, 1.4TSIEcoFuel, 1.6, 1.6FSI, 1.9TDI, 2.0 EcoFuel, 2.0 FSI, 2.0 TDI, 2.0 TDI 16V		E	'E	'H	RE5841

TOURAN (1T3)

05/2010 → 05/2015

Control Arm-/Trailing Arm Bush	1.2 TSI, 1.4 TSI, 1.4 TSI EcoFuel, 1.6 TDI, 2.0 TDI	Rubber-metal Bearing	E	'E	'H	BS6899
Rod/Strut, stabiliser	1.2 TSI, 1.6 TDI, 2.0 TDI	Material: Steel	E	'E	'H	CTR5849
Tie Rod Axle Joint	1.2 TSI, 1.4 TSI, 1.4 TSI EcoFuel, 1.6 TDI, 2.0 TDI	for vehicles with electric power steering	E	'E	'H	RE5841

TRANSPORTER / CARAVELLE Mk III Bus

05/1979 → 07/1992

Tie Rod End	1.6, 1.6D, 1.6TD, 1.6TD Syncro, 1.7D, 1.9, 1.9 Syncro, 2.0, 2.1, 2.1 i, 2.1 Syncro		E	'E	'H	CTR5140
-------------	--	--	---	----	----	---------

TRANSPORTER Mk III Box

05/1979 → 07/1992

Tie Rod End	1.6, 1.6D, 1.6TD, 1.6TD Syncro, 1.7D, 1.9, 1.9 Syncro, 2.0, 2.1, 2.1 i, 2.1 Syncro		E	'E	'H	CTR5140
-------------	--	--	---	----	----	---------

TRANSPORTER Mk III Platform/Chassis

05/1979 → 07/1992

Tie Rod End	1.6TD, 1.6TDSyncro, 1.7D, 1.9, 1.9 Syncro, 2.0, 2.1, 2.1 i, 2.1 Syncro		E	'E	'H	CTR5140
-------------	--	--	---	----	----	---------

TRANSPORTER / CARAVELLE Mk IV Bus (70XB, 70XC, 7DB, 7DW, 7DK)

09/1990 → 04/2003

Tie Rod Axle Joint	1.9 D, 1.9 TD, 2.0, 2.4 D, 2.5, 2.5 TDI, 2.8 VR 6	ch.70-T-200001 →; 01/1996 →; with rubber grommet; for vehicles with power steering	E	'E	'H	RE5718
Tie Rod Axle Joint	2.4 D [AJA], 2.5 [AET, APL, AVT], 2.5 Syncro [AET, APL, AVT], 2.5 TDI, 2.5 TDI Syncro, 2.8 Syncro, 2.8 V6	with rubber grommet; for vehicles with power steering	E	'E	'H	RE5718
Tie Rod Axle Joint	2.4 D Syncro, 2.5 Syncro	ch.70-T-200000 →; 01/1996 →; with rubber grommet; for vehicles with power steering	E	'E	'H	RE5718

						
BS6883	BS6884	BS6899	CTR5140	CTR5849	RE5718	RE5841
Ref.Nr.: 1K0199231J	Ref.Nr.: 1K0199232J	Ref.Nr.: 1K0407182	Ref.Nr.: 32111116463	Ref.Nr.: 1K0411315G	Ref.Nr.: 701419810B	Ref.Nr.: 1K0423810A

Article Description			Fitting Position	Article No.
---------------------	--	--	------------------	-------------

TRANSPORTER Mk IV Box (70XA)
07/1990 → 04/2003

Tie Rod Axle Joint	1.9 D, 1.9 TD, 2.0, 2.4 D, 2.5, 2.5 TDI, 2.8 VR 6	ch.70-T-200001→; 01/1996 →; with rubber grommet; for vehicles with power steering	E	'E	'H	RE5718
Tie Rod Axle Joint	2.4 D [AJA], 2.5 [AET,APL,AVT], 2.5 Syncro [AET,APL,AVT], 2.5 TDI, 2.5 TDI Syncro, 2.8 Syncro, 2.8 V6	with rubber grommet; for vehicles with power steering	E	'E	'H	RE5718
Tie Rod Axle Joint	2.4 D Syncro, 2.5 Syncro	ch.70-T-200000→; 01/1996 →; with rubber grommet; for vehicles with power steering	E	'E	'H	RE5718

TRANSPORTER Mk IV Platform/Chassis (70XD)
07/1990 → 04/2003

Tie Rod Axle Joint	1.9 D, 1.9 TD, 2.0, 2.4 D, 2.5, 2.5 TDI, 2.8 VR 6	ch.70-T-200001→; 01/1996 →; with rubber grommet; for vehicles with power steering	E	'E	'H	RE5718
Tie Rod Axle Joint	2.4 D [AJA], 2.5 [AET,APL,AVT], 2.5 Syncro [AET,APL,AVT], 2.5 TDI, 2.5 TDI Syncro, 2.8 Syncro, 2.8 V6	with rubber grommet; for vehicles with power steering	E	'E	'H	RE5718
Tie Rod Axle Joint	2.4 D Syncro, 2.5 Syncro	ch.70-T-200000→; 01/1996 →; with rubber grommet; for vehicles with power steering	E	'E	'H	RE5718

MULTIVAN Mk V (7HM, 7HN, 7HF, 7EF, 7EM, 7EN)
04/2003 → 11/2009

Control Arm-/Trailing Arm Bush	1.9 TDI, 2.0, 2.5 TDI, 3.2 V6	Rubber-metal Bearing	E	'E	'H	BS8271
Control Arm-/Trailing Arm Bush	1.9 TDI, 2.0, 2.0 BiTDI, 2.0 BiTDI 4motion, 2.0 TDI, 2.0 TDI 4motion, 2.0 TSI, 2.0 TSI 4motion, 2.5 TDI, 2.5 TDI 4motion, 3.2 4motion, 3.2 V6, 3.2 V6 4motion	Rubber-metal Bearing	E	'E	'H	BS8272
Ball Joint	1.9 TDI, 2.0, 2.0 BiTDI, 2.0 BiTDI 4motion, 2.0 TDI, 2.0 TDI 4motion, 2.0 TSI, 2.0 TSI 4motion, 2.5 TDI, 2.5 TDI 4motion, 3.2 4motion, 3.2 V6, 3.2 V6 4motion		E	'E	'H	CJ1163

TRANSPORTER / CARAVELLE Mk V Bus (7HB, 7HJ, 7EB, 7EJ, 7EF, 7...)
04/2003 → 11/2009

Control Arm-/Trailing Arm Bush	1.9 TDI, 2.0, 2.0 TDI, 2.0 TSI, 2.0 TSI 4motion, 2.5 TDI, 2.5 TDI 4motion, 3.2 4motion, 3.2 V6, 3.2 V6 4motion	Rubber-metal Bearing	E	'E	'H	BS8272
Ball Joint	1.9 TDI, 2.0, 2.0 TDI, 2.0 TSI, 2.0 TSI 4motion, 2.5 TDI, 2.5 TDI 4motion, 3.2 4motion, 3.2 V6, 3.2 V6 4motion	Gross Vehicle Weight [kg]: 2600, 2800, 2850, 3000	E	'E	'H	CJ1163

TRANSPORTER Mk V Box (7HA, 7HH, 7EA, 7EH)
04/2003 → 11/2009

Control Arm-/Trailing Arm Bush	1.9 TDI, 2.0, 2.0 TDI, 2.0 TDI 4motion, 2.0 TSI, 2.0 TSI 4motion, 2.5 TDI, 2.5 TDI 4motion, 3.2 4motion, 3.2 V6	Rubber-metal Bearing	E	'E	'H	BS8272
Ball Joint	1.9 TDI, 2.0, 2.0 TDI, 2.0 TDI 4motion, 2.0 TSI, 2.0 TSI 4motion, 2.5 TDI, 2.5 TDI 4motion, 3.2 4motion, 3.2 V6	Gross Vehicle Weight [kg]: 2600, 2800, 2850, 3000	E	'E	'H	CJ1163

TRANSPORTER Mk V Platform/Chassis (7JD, 7JE, 7JL, 7JY, 7JZ)
04/2003 → 11/2009

Control Arm-/Trailing Arm Bush	1.9 TDI, 2.0, 2.0 TDI, 2.0 TDI 4motion, 2.0 TSI, 2.5 TDI, 2.5 TDI 4motion, 3.2 V6	Rubber-metal Bearing	E	'E	'H	BS8272
Ball Joint	1.9 TDI, 2.0, 2.0 TDI, 2.0 TDI 4motion, 2.0 TSI, 2.5 TDI, 2.5 TDI 4motion, 3.2 V6	for vehicles with double-cab	E	'E	'H	CJ1163

UP
08/2011 →

Control Arm-/Trailing Arm Bush	1.0		E	'E	'H	BS6417
Control Arm-/Trailing Arm Bush	1.0		E	'E	'H	BS6911
Rod/Strut, stabiliser	1.0, 1.0 EcoFuel, e-Up	Material: Steel	E	'E	'H	CTR5605
Top Strut Mounting	1.0, 1.0 EcoFuel	without ball bearing	E	'E	'H	MO6180

BS6417	BS6911	BS8271	BS8272	CJ1163	CTR5605	MO6180
Ref.Nr.: 1J0407181	Ref.Nr.: 191407182	Ref.Nr.: 7H0407182A	Ref.Nr.: 2H0407183A	Ref.Nr.: 7H0407361A	Ref.Nr.: 6Q0411315E	Ref.Nr.: 1J0412331B
RE5718						
Ref.Nr.: 701419810B						

ORIGINAL-NO.

AUDI

171419821	RE033
191407182	BS6911
191422803APART	RE5473
1J0407181	BS6417
1J0407365A	CJ986
1J0407365C	CJ986
1J0407365D	CJ986
1J0407365H	CJ986
1J0407365J	CJ986
1J0407366A	CJ987
1J0407366C	CJ987
1J0407366D	CJ987
1J0407366H	CJ987
1J0407366J	CJ987
1J0412331	MO6180
1J0412331B	MO6180
1J0412331C	MO6180
1J0422807B	RE8143
1J0422811B	CTR5706L
1J0422812B	CTR5706R
1K0199231G	BS6883
1K0199231J	BS6883
1K0199232G	BS6884
1K0199232J	BS6884
1K0407182	BS6899
1K0407182A	BS6899
1K0411315B	CTR5849
1K0411315D	CTR5849
1K0411315G	CTR5849
1K0411315J	CTR5849
1K0411315K	CTR5849
1K0411315N	CTR5849
1K0411315P	CTR5849
1K0411315R	CTR5849
1K0423810A	RE5841
357407182	BS6911
4B0419811	CTR5491
4B0419811B	CTR5491
4B0419811C	CTR5491
4B0419811D	CTR5491
4B0419811E	CTR5491
4B0419811F	CTR5491
4D0407183D	BS7069
4D0407183M	BS7069
4D0407183N	BS7069
4D0407183P	BS7069
4D0407183Q	BS7069
4D0407509B	CJ1034
4D0407509D	CJ1034
4D0407509K	CJ1034
4D0407510B	CJ1035
4D0407510D	CJ1035

AUDI

4D0407510K	CJ1035
4D0407515	BS7072
4D0407515C	BS7072
4D0407693AC	CJ292
4D0407693AD	CJ292
4D0407693E	CJ292
4D0407693H	CJ292
4D0407693K	CJ292
4D0407693M	CJ292
4D0407693N	CJ292
4D0407694AC	CJ293
4D0407694AD	CJ293
4D0407694E	CJ293
4D0407694H	CJ293
4D0407694K	CJ293
4D0407694M	CJ293
4D0407694N	CJ293
4D0419811A	CTR5491
4D0419811B	CTR5491
4D0419811G	CTR5491
4D0419811H	CTR5491
4F0419811E	CTR5491
4F0498811	CTR5491
6Q0411315A	CTR5605
6Q0411315B	CTR5605
6Q0411315C	CTR5605
6Q0411315D	CTR5605
6Q0411315E	CTR5605
6Q0411315F	CTR5605
6Q0411315G	CTR5605
6Q0411315H	CTR5605
6Q0411315J	CTR5605
6Q0411315L	CTR5605
6Q0411315M	CTR5605
6Q0411315N	CTR5605
6Q0411315P	CTR5605
6R0411315	CTR5605
6R0411315A	CTR5605
8D0407505B	CJ287
8D0407505F	CJ287
8D0407505H	CJ287
8D0407505K	CJ287
8D0407506B	CJ1033
8D0407506F	CJ1033
8D0407506H	CJ1033
8D0407506K	CJ1033
8E0407151E	CJ1175
8E0407151K	CJ1175
8E0407151L	CJ1175
8E0407151M	CJ1175
8E0407151N	CJ1175
8E0407151R	CJ1175

AUDI

8E0407505A	CJ287
8E0407693E	CJ292
8E0407694E	CJ293
8E0419811B	CTR5491
8Z0411315D	CTR5605

BMW

31111096982	BS7205
31121092023	CJ1065L
31121092024	CJ1065R
31121093449	CJ1066L
31121093450	CJ1066L
31121093450	CJ1066R
31121094233	CJ1066L
31121094234	CJ1066R
31121094275	CJ870L
31121094276	CJ870R
31121094465	CJ143
31121094466	CJ142
31121095277	BS7205
31121095278	BS7205
31121096685	CJ863
31121096983	BS7205
31121096984	BS7205
31121096985	CJ143
31121096986	CJ142
31121126253	CJ848
31121126254	CJ847
31121126296	CJ848
31121130123	BS5422
31121130140	BS5422
31121133710	BS6177
31121136529	CJ870L
31121136530	CJ870R
31121139131	CJ848
31121140398	CJ863
31121140399	CJ870L
31121140400	CJ870R
31121140957	CJ870L
31121140958	CJ870R
31121141717	CJ1065L
31121141718	CJ1065R
31122347951	CJ1152
31122347952	CJ1151
31122347963	CJ1152
31122347965	CJ1151
31122405861	CJ1149
31122405862	CJ1150
31122409598	CJ1150
31122409599	CJ1149
31124000612	BS7205
31124004359	BS7204
31124004359	BS7205

BMW

31124004360	BS7205
31124028607	CJ1152
31124028608	CJ1151
31124036269	CJ1149
31124036270	CJ1150
31126750057S1	BS7205
31126750221	BS7205
31126750222	BS7205
31126750223	CJ143
31126750224	CJ142
31126751317	CJ143
31126751318	CJ142
31126751372	BS7205
31126751435	BS7205
31126751436	BS7205
31126752717	CJ143
31126752718	CJ142
31126753058	BS7205
31126753059	BS7205
31126753060	BS7205
31126754547	BS7205
31126754899	BS7205
31126754900	BS7205
31126757623	BS7205
31126758510	CJ863
31126758513	CJ870L
31126758514	CJ870R
31126758515	CJ870L
31126758516	CJ870R
31126758519	CJ143
31126758520	CJ142
31126760181	CJ1152
31126760182	CJ1151
31126763703	CJ1149
31126763704	CJ1150
31126763707	CJ1149
31126763708	CJ1150
31126768297	CJ1152
31126768298	CJ1151
31126769797	CJ1149
31126769798	CJ1150
31126769801	CJ1149
31126769802	CJ1150
31126770247	CJ143
31126770248	CJ142
31126774819	CJ143
31126774820	CJ142
31126777851	CJ143
31126777852	CJ142
31129058931	BS5422
31129059288	BS5421
31129071663	BS7205

ORIGINAL-NO.

ORIGINAL-NO.

BMW

31129071952	BS7205
31129071963	BS7205
31351091764	CTR5159
31351095694	CTR5605
31351124380	CTR5380
31351127194	CTR5380
31351127689	CTR5159
31351128050	CTR5380
31351128737	CTR5159
31351130075	CTR5380
31351134582	CTR5380
31352227203	CTR5380
31356765933	CTR5875L
31356765934	CTR5875R
31356780847	CTR5605
32106774347PART	RE5845
32106777479PART	RE5845
32111091767*	RE5549
32111091767PART	RE5549
32111091768*	RE5549
32111091768PART	RE5549
32111096897PART	RE5604
32111127124	RE5472
32111130449	RE5472
32111139315PART	RE046
32111139316PART	RE046
32111139318PART	RE5489
32216762243	RE5843
32216762244	RE5843
32216762403PART	RE5845

CHEVROLET

26011925	CTR5506
26059294	CTR5170
26087868	CTR5506
90141393	CJ951
90295479	CJ951
90297863	CJ951
90487561	CJ1089
90496116	CTR5771
90512982	CJ1089
90542995	CJ1089
9118127	CTR5170
93186537	CTR5170
93192419	CTR5506
96391875	CTR5891
96535081	CJ269L
96535082	CJ269R
96535088	BS8315
96653381	BS8315
96815893	CJ269L
96815894	CJ269R
96870465	CJ269L

CHEVROLET

96870466	CJ269R
----------	--------

CHRYSLER

04797706	CTR6107
4797706	CTR6107
5099237AA	CJ1028
68020843AA	RE5928
68020845AA	CTR5927
68047089AA	CTR5927

CITROËN

508750	CTR6130
--------	---------

DAEWOO

1603302	CJ869
96129753	CTR5141
96205809	CTR5141
96275798	CTR5891
96391875	CTR5891
96446586	CTR5141
96535081	CJ269L
96535082	CJ269R
96535088	BS8315
96653381	BS8315
96815893	CJ269L
96815894	CJ269R
96870465	CJ269L
96870466	CJ269R
D96205809	CTR5141
D96275798	CTR5891
D96391875	CTR5891

FIAT

05958246	CTR5401
05960254	MO5809
46543045	CJ1045
5958246	CTR5401
5958247	CTR5401
5960254	MO5809
5983404	CTR5401
5983406	CTR5401
SE127162410A	CTR5401

FORD

1003574	CJ159R
1003575	CJ159R
1003584	CJ159L
1003585	CJ159L
1004011	BS7411
1004018	CTR5318
1009580	CJ159R
1009584	CJ159R
1009594	CJ159L
1009596	CJ159L
1010037	BS6496
1014654	BS7411
1015260	CJ159R

FORD

1015264	CJ159L
1017013	CJ159R
1017014	CJ159L
1021219	CJ159R
1021220	CJ159L
1030025	CJ582
1030026	CJ582
1045655	CJ159R
1045656	CJ159L
1046280	CJ159R
1046282	CJ159L
1046283	CJ159R
1046285	CJ159L
1047797	CJ582
1047798	CJ582
1055191	BS6496
1058279	CJ124
1058280	CJ125
1061631	CTR5318
1063236	CJ159R
1063255	CJ159L
1063372	BS7411
1067818	CTR5318
1130273	CTR5318
1135077	CTR5318
1146150	CTR6172
1223792	CTR5923
1230909	CTR5923
1310333	CTR6191
1315074	CTR5921R
1315083	CTR5921L
1335548	CTR6191
1454896	CTR5308
1469208	CTR6191
1469212	CTR6172
1470387	CJ1259
1513343	CTR1418
1545457	RE6092
1637182	CJ964
1637183	CJ964
1637184	CJ965
1637185	CJ965
1661237	CTR5318
1679388	CJ1259
1745924	CTR1418
1761200	CTR6172
1790310	CTR1418
1905043	CTR1418
1E0034153A	BS6496
1E0034170	CTR5318
1E0134153A	BS7411
1S613B438AA	CTR5318

FORD

2S613B438AC	CTR6172
2S613B438AD	CTR6172
2S613B438AE	CTR6172
3240196	CJ843
3240197	CJ844
3246129	CJ844
3246130	CJ843
3669093	CTR5335
3M513B438AB	CTR5923
3M513K209BA	CJ1259
4342539	RE5571
5021456	CJ843
5021457	CJ844
5021458	CJ964
5021459	CJ965
6084942	CJ843
6084943	CJ844
6087888	CJ843
6087889	CJ844
6115333	CJ843
6115334	CJ843
6115335	CJ844
6115336	CJ844
6131083	RE5407
6134277	RE5407
6135757	RE5450
6185335	RE5407
6185336	RE5407
6185338	RE5450
6186082	CTR5318
6188004	CTR5318
6198621	CTR5318
6525743	CJ124
6525843	CJ124
6525844	CJ125
6615742	CJ124
6615743	CJ125
6732630	CJ124
6732631	CJ125
6770224	CJ124
6770225	CJ125
6829045	CJ1259
7102644	CJ124
7102645	CJ125
7152281	CJ582
7351747	CJ124
7351748	CJ125
81AB3A052AC	CJ843
81AB3A053AC	CJ844
83BB3L519EA	RE5407
86AB3078A2A	CJ843
86AB3079A1A	CJ965

ORIGINAL-NO.

FORD

86AB3079A2A	CJ965
87BB3L519DA	RE5407
87BB3L519EA	RE5407
87GB3L519BA	RE5450
880X3B376CA	CJ964
89FB3B438A1E	CTR5318
8AU334510	CJ983
8V513B438AB	CTR1418
8V513B438BA	CTR1418
8V513B438BB	CTR1418
8V513B438BC	CTR1418
8V513L519AA	RE6092
91AB3042AB	CJ124
91AB3042AD	CJ124
91AB3051AD	CJ125
92AB3042AA	CJ124
92AB3042BA	CJ124
92AB3051AA	CJ125
92AB3051BA	CJ125
93BB5K653AB	CJ1259
94AB3042AA	CJ124
94AB3051AA	CJ125
94FB3395A2A	CJ582
94FB3395A2B	CJ582
94FB3B376AA	CJ582
95AB3042AB	CJ124
95AB3042AE	CJ124
95AB3051AB	CJ125
95AB3051AD	CJ125
95AB3051AE	CJ125
96FB3042BF	CJ159R
96FB3042BG	CJ159R
96FB3051BF	CJ159L
96FB3051BG	CJ159L
96FB3063AA	BS6496
96FB3063AB	BS6496
96FB3A262AD	BS7411
96FB3B438AB	CTR5318
98AG3B438AB	CTR5318
98FB3042CC	CJ159R
98FB3051CC	CJ159L
98FB3063AA	BS6496
98FB3A262AA	BS7411
K9597	CJ919
ME4M5J3395AA	CJ1259
UR5632250	CTR5984
UR6134550	CJ1205
XM343289BA	CTR5335
YS413B438BA	CTR5318

FOTON

4504629325	CTR5005A
4550329565	RE188

GONOW

4333039165	CJ934
4335039035	CJ933

GWM

4333039165	CJ934
4335039035	CJ933

HOLDEN

90141393	CJ951
90295479	CJ951
90297863	CJ951
90487561	CJ1089
90496116	CTR5771
90512982	CJ1089
90542995	CJ1089

HONDA

51220SA0A01	CJ962
51220SB0003	CJ962
51220SE0000	CJ962
51220SE0003	CJ962
51220SF1000	CJ962
51220SF1100	CJ962
51220SH3003	CJ962
51220SK7003	CJ962
51220SK7013	CJ962
51220SM0A01	CJ962
51320S04003	CTR5552
51450S01023	CJ610R
51460S01023	CJ610L
53010S04000	RE5908
53010SR3010	RE071
53540SH3003	CTR5345R
53540SH3013	CTR5345R
53560SH3003	CTR5345L
53560SH3013	CTR5345L

HYUNDAI

5450322A00	CJ1011
5450331600	CJ1011
5452031600	CJ1011
5453014200	CJ1011
5453031600	CJ1011
545842E000	BS7860
548301C000	CTR5915L
5483029000	CTR6032
548401C000	CTR5915R
5553029000	CTR3107
5553029500	CTR3107
5553029500AS	CTR3107
5682025000	CTR5474
5682028520	CTR5474
5682037010	CTR5474
568203B000	CTR5567
5685028520	CTR5474
577240X000	RE6055

ISUZU

324057	CTR5331R
8944194080	CTR5331R
8944194081	CTR5331R
8944194090	CTR5331L
8944194091	CTR5331L
89444594642	CJ936
8944521020	CJ946
8944521021	CJ946
8944594532	CJ930
8944594533	CJ930
8944594534	CJ930
8944594641	CJ936
8944594642	CJ936
8944594651	CJ946
8944594652	CJ946
8944594800	CTR5331R
8944594802	CTR5331R
8944594810	CTR5331L
8944594812	CTR5331L
897304855051	CTR5806
8979445680	CTR6182R
8979445690	CTR6182L
898005827051	CJ1221
920373	CTR5331R
94419408	CTR5331R
94452102	CJ946
94459464	CJ936
94459480	CTR5331R

KIA

545842E000	BS7860
------------	--------

MAZDA

1010037	BS6496
1014654	BS7411
1055191	BS6496
1063372	BS7411
1130273	CTR5318
1335548	CTR6191
1E0034153A	BS6496
1E0034170	CTR5318
1E0034300A	CJ159R
1E0034350A	CJ159L
1E0134153A	BS7411
1E0134300A	CJ159R
1E0134350A	CJ159L
6M343280AA	CTR5308
8AB032280	CTR5184
8AB232280	CTR5184
8AU132280	CTR5335
8AU334510	CJ983
94FB3395A2B	CJ582
B00134550	CJ926
B09232240	RE014

MAZDA

B09234550	CJ926
B32H34300	CJ294R
B32H34300A	CJ294R
B32H34300B	CJ294R
B32H34300C	CJ294R
B32H34300D	CJ294R
B32H34300E	CJ294R
B32H34350	CJ294L
B32H34350A	CJ294L
B32H34350B	CJ294L
B32H34350C	CJ294L
B32H34350D	CJ294L
B32H34350E	CJ294L
B37F34300	CJ294R
B37F34300A	CJ294R
B37F34300B	CJ294R
B37F34350	CJ294L
B37F34350A	CJ294L
B37F34350B	CJ294L
B45532280	CTR5184
BF6232240	RE014
BF6732240	RE014
BF673224X	RE014
BP4K28170C	CTR6191
BP4K28170D	CTR6191
BP4K34170C	CTR5923
BP4K34300	CJ294R
BP4K34300A	CJ294R
BP4K34300B	CJ294R
BP4K34300C	CJ294R
BP4K34300D	CJ294R
BP4K34300E	CJ294R
BP4K34350	CJ294L
BP4K34350A	CJ294L
BP4K34350B	CJ294L
BP4K34350C	CJ294L
BP4K34350D	CJ294L
BP4K34350E	CJ294L
BP4L32240	RE5946
C51334300	CJ294R
C51334350	CJ294L
CC3034300	CJ294R
CC3034300A	CJ294R
CC3034300B	CJ294R
CC3034300C	CJ294R
CC3034300D	CJ294R
CC3034300E	CJ294R
CC3034350	CJ294L
CC3034350A	CJ294L
CC3034350B	CJ294L
CC3034350C	CJ294L
CC3034350D	CJ294L

ORIGINAL-NO.

MAZDA

CC3034350E	CJ294L
D65132240	RE6092
D65134170	CTR1418
D65134170A	CTR1418
DD3234170	CTR6172
DD3234170A	CTR6172
DD3234170B	CTR6172
GJ6A32240	RE5948
GJ6A34300B	CJ1199
GJ6A34300C	CJ1199
GJ6A34300D	CJ1199
K9597	CJ919
LC6234170	CTR5527
LC6234170B	CTR5527
UH7432280	CTR5335
UR5632250	CTR5984
UR6134550	CJ1205

MERCEDES-BENZ

0013307435	CTR5497
0013307735	CTR5497
1233380210	CTR5172
1693330127	CJ1143
2023330027	CJ1028
2033200489	CTR5783
2033202589	CTR5783
2033202889	CTR5783
2033300111	CJ997L
2033300211	CJ997R
2033301611	CJ997L
2033301711	CJ997R
2033301903	CTR5781L
2033301911	CJ996L
2033302011	CJ996R
2033303311	CJ996L
2033303411	CJ996R
2033303511	CJ997L
2033303611	CJ997R
2033303903	CTR5781L
2033303911	CJ997L
2033304011	CJ997R
2043201889	CTR6047R
2043301911	CJ996L
2043302011	CJ996R
2043304311	CJ997L
2043304411	CJ997R
2103300035	CJ1028
2103330427	CJ1028
2103380415	RE5444
2113300235	CJ1193
2113300335	CJ1028
2113300435	CJ1193
2203300635	CJ1028

MERCEDES-BENZ

2203330127	CJ1193
2203330227	CJ1193
2203330327	CJ1193
2203330427	CJ1193
2203330727	CJ1193
2203380715	RE5782
2303380015	RE5782
9014600048	CTR5542
9014600148	CTR5542
9014600248	CTR5542
9014600348	CTR5542
90610481001	CTR5927
90610481003	CTR5927
90610551003	RE5928
9064600048	CTR5927
9064600055	RE5928
9064600148	CTR5927
9064600348	CTR5927

MINI

31351130075	CTR5380
31351134582	CTR5380

MITSUBISHI

MB831037	CJ961L
MB831038	CJ961R
MB831043	CTR5557
MB831044	CTR5556
MB860829	CJ904
MB860830	CJ904
MR296269	CJ961L
MR296270	CJ961R

NISSAN

4016001G00	CJ912
4016001G25	CJ912
4016001G50	CJ912
4016001G90	CJ912
4016001N25	CJ912
40160B1001	CJ787
485200W025	CTR5700
48520H1001	CTR1367R
4852101G25	CTR5310
485212S425	CTR5601
4852131G25	CTR5309
485213U025	RE5990
4852150400	RE053
4852150Y00	RE053
48521H1001	CTR1366R
48521H5025	CTR1366R
48521W5025	CTR1366R
4857031G25	CTR5309
485703S500	CTR5699
48640H1001	CTR1367L
48641H1001	CTR1366L

NISSAN

48641H5025	CTR1366L
48641W5025	CTR1366L
54500AX600	BS8147
54500AX600	BS8218
54500BC41A	BS8147
54500BC42A	BS8147
54501AX600	BS8147
54501AX600	BS8218
54501BC41A	BS8147
54501BC42A	BS8147
54560AX600	BS8147
54560AX600	BS8218
54570AX600	BS8218
5461600QAA	BS8131
546184M400	CTR5682
5461850Y00	CTR5559
5461858820	CTR5559
546188H300	CTR5675R
54618AX600	CTR5770
54618D5000	CTR5559
54618D5010	CTR5559
54618EA010	CTR6150R
54618EB30A	CTR6150R
546688H300	CTR5675L
54668EA010	CTR6150L
54668EB30A	CTR6150L
D8520VK91A	CTR5600

OPEL

025260037576	CJ869
0322158	RE5815
0324053	CTR5427L
0324054	CTR5427R
0324055	CTR5427L
0324056	CTR5427R
0344523	MO6848
0352074	CJ1501L
0352075	CJ1501L
0352076	CJ1501R
0352077	CJ1501L
0352143	CJ1501L
0352163	CJ1501L
0352192	CJ1501R
0352193	CJ1501L
0352300	BS6406
0352346	BS6406
0352347	BS6383
0352348	BS6383
0352351	BS6406
0352352	BS6383
0352822	CJ946
0352828	CJ946
0920373	CTR5331R

OPEL

0920374	CTR5331L
1603008	RE5499
1603009	CTR5506
1603018	RE056
1603121	CJ951
1603163	CJ951
1603167	CJ951
1603202	CJ869
1603213	RE5547
1603214	CTR5170
1603215	CTR5170
1603216	RE5547
1603287	RE5547
1603302	CJ869
1603303	RE5547
1603455	CTR5500
1603542	CTR5170
1603645	CTR5506
1603843	RE056
1603845	RE5499
310821	CJ930
322158	RE5815
324050	CTR5506
324053	CTR5427L
324054	CTR5427R
324055	CTR5427L
324056	CTR5427R
324066	CTR5500
344523	MO6848
350263	CTR5643
350610	CTR5771
350611	CTR2462
350614	CTR2462
352074	CJ1501L
352075	CJ1501L
352076	CJ1501R
352077	CJ1501L
352143	CJ1501L
352163	CJ1501L
352192	CJ1501R
352193	CJ1501L
352300	BS6406
352309	BS6102
352310	BS6103
352320	BS6103
352346	BS6406
352347	BS6383
352348	BS6383
352351	BS6406
352352	BS6383
352800	CJ1089
352803	CJ654

ORIGINAL-NO.

OPEL

352822	CJ946
352828	CJ946
352829	CJ1089
352830	CJ1089
5352000	CJ1501R
5352001	CJ1501L
5352015	CJ1501L
8944594652	CJ946
90268463	BS6383
90288082	BS6383
90288232	BS6406
90373778	BS6406
90373779	CJ1501L
90468554	MO6848
90473226	CJ1501L
90473227	CJ1501R
90495103	CJ1501L
90495104	CJ1501R
90495159	CJ1501L
90495160	CJ1501R
90539896	CJ869
920373	CTR5331R
920374	CTR5331L
94459465	CJ946
94459481	CTR5331L

PEUGEOT

3812C5	RE5651
508750	CTR6130
96347856	CTR6130

PORSCHE

171407153D	CJ108
171407181APART	CJ108
171407182DPART	CJ108
171407365F	CJ832
171407365G	CJ832
171419811	CTR5140

RENAULT

6001547606	RE5986
6001547610	CTR5985L
6001547611	CTR5985R
6001550441	RE5986
6001550442	CTR5985L
6001550443	CTR5985R
7700418941	BS6002
7700419236	BS6002
7700419249	BS6002
7700424399	BS6002
7700799404	BS8131
7701047415	CTR5726L
7701047416	CTR5726R
7701047812	CTR5726L
7701047813	CTR5726R

RENAULT

7701474448	RE5902
7701474492	CTR5726L
7701474493	CTR5726R
7701475842	CTR5726L
7701475843	CTR5726R
7701476760	CTR5726L
7701476761	CTR5726R
7701476762	CTR5726L
7701476763	CTR5726R
8200041166	BS6819
8200127308	CTR5770
8200183569	BS8147
8200183570	BS8218
8200298454PART	CJ1145
8200298455PART	CJ1145
8200346941	BS8147
8200346941	BS8218
8200346941	CJ1145
8200346941	CJ299L
8200346942	BS8147
8200346942	BS8218
8200346942	CJ1145
8200346942	CJ299R
8200457209	CJ1145
8200615057	CJ1145
8200615057	CJ299L
8200615058	CJ1145
8200615058	CJ299R
8200679067	CJ1145
8200696437	BS8218
8200744091	CJ1145
8200744091	CJ299L
8200744092	CJ1145
8200744092	CJ299R

SAAB

30540743	CTR5643
4242749	CTR5427L
4242756	CTR5427R
4400040	CTR5643
4544599	CTR5643
4686606	CTR5771
4835740	CJ1089
5231683	CJ1089
5236823	CTR5771
93185278	CJ1089

SUBARU

20470SA010	CTR0300
20470SA011	CTR0300

SUZUKI

4520069D00	CJ1084
4520084000	CJ1084

TOYOTA

TOYOTA

	CJ1168L
	CJ1168R
	CJ1169
	CJ1170L
	CJ1170R
	CJ1188
4333009070	CJ949
4333009090	CJ949
4333009230	CJ949
4333009295	CJ1187
4333009490	CJ1187
4333009510	CJ1187
4333009640	CJ949
4333019065	CJ915
4333019066	CJ915
4333019115	CJ949
4333029125	CJ931
4333029135	CJ935
4333029136	CJ935
4333029137	CJ935
4333029138	CJ935
4333029139	CJ935
4333029140	CJ935
4333029175	CJ281
4333029205	CJ935
4333039165	CJ934
4333049045	CJ949
4333069015	CJ949
4334019015	CJ914
4334019016	CJ914
4334029105	CJ931
4335029045	CJ932
4335029056	CJ932
4335029065	CJ984
4335029095	CJ984
4335039035	CJ933
4335039045	CJ981
4336029065	CJ932
4336029076	CJ932
4336039085	CJ981
4504609020	CTR5429L
4504609360	CTR5470R
4504619175	CTR5343A
4504619265	CTR5470R
4504629115	CTR5300
4504629125	CTR5300
4504629215	CTR5005
4504629255	CTR5429L
4504629305	CTR5343A
4504629325	CTR5005A
4504629456	CTR5812
4504639105	CTR5300

TOYOTA

4504639106	CTR5300
4504639125	CTR5300
4504639165	CTR5300
4504639175	CTR5300
4504639215	CTR5300
4504639235	CTR5300
4504639355	CTR5300
4504639375	CTR5300
4504639385	CTR5300
4504649115	CTR5470R
4504660081	CTR5005
4504669055	CTR5005
4540629115	CTR5301
4540629145	CTR5317
4540629175	CTR5317
4550002130	RE5957
4550002300	RE5957
4550312130	RE2406
4550319116	RE049
4550319125	RE030
4550319215	RE5463
4550329255	RE049
4550329565	RE188
4550329565	RE188
4550349105	RE5975
4551012390	RE5957
4806802020	CJ266R
4806802021	CJ266R
4806802030	CJ266R
4806802070	CJ266R
4806802080	CJ266R
4806812220	CJ266R
4806812260	CJ266R
4806813010	CJ266R
4806902020	CJ266L
4806902021	CJ266L
4806902030	CJ266L
4806902070	CJ266L
4806902080	CJ266L
4806912220	CJ266L
4806912260	CJ266L
4806913010	CJ266L
4865507010	BS8424
4865512120	BS6455
4865533010	BS8424
488200K010	CTR6115
4882042030	CTR6160
4882047010	CTR5916
48820B0010	CTR6211
4883020010	CTR5534

VOLVO

032119554	CTR5140
-----------	---------

ORIGINAL-NO.

AUDI		AUDI		AUDI		BMW	
BS6417	1J0407181	CJ293	8E0407694E	MO6180	1J0412331C	CJ1150	31122405862
BS6883	1K0199231G	CJ986	1J0407365A	RE033	171419821	CJ1150	31122409598
BS6883	1K0199231J	CJ986	1J0407365C	RE5473	191422803APART	CJ1150	31124036270
BS6884	1K0199232G	CJ986	1J0407365D	RE5841	1K0423810A	CJ1150	31126763704
BS6884	1K0199232J	CJ986	1J0407365H	RE8143	1J0422807B	CJ1150	31126763708
BS6899	1K0407182	CJ986	1J0407365J	BMW		CJ1150	31126769798
BS6899	1K0407182A	CJ987	1J0407366A	BS5421	31129059288	CJ1150	31126769802
BS6911	191407182	CJ987	1J0407366C	BS5422	31121130123	CJ1151	31122347952
BS6911	357407182	CJ987	1J0407366D	BS5422	31121130140	CJ1151	31122347965
BS7069	4D0407183D	CJ987	1J0407366H	BS5422	31129058931	CJ1151	31124028608
BS7069	4D0407183M	CJ987	1J0407366J	BS6177	31121133710	CJ1151	31126760182
BS7069	4D0407183N	CTR5491	4B0419811	BS7204	31124004359	CJ1151	31126768298
BS7069	4D0407183P	CTR5491	4B0419811B	BS7205	31111096982	CJ1152	31122347951
BS7069	4D0407183Q	CTR5491	4B0419811C	BS7205	31121095277	CJ1152	31122347963
BS7072	4D0407515	CTR5491	4B0419811D	BS7205	31121095278	CJ1152	31124028607
BS7072	4D0407515C	CTR5491	4B0419811E	BS7205	31121096983	CJ1152	31126760181
CJ1033	8D0407506B	CTR5491	4B0419811F	BS7205	31121096984	CJ1152	31126768297
CJ1033	8D0407506F	CTR5491	4D0419811A	BS7205	31124000612	CJ142	31121094466
CJ1033	8D0407506H	CTR5491	4D0419811B	BS7205	31124004359	CJ142	31121096986
CJ1033	8D0407506K	CTR5491	4D0419811G	BS7205	31124004360	CJ142	31126750224
CJ1034	4D0407509B	CTR5491	4D0419811H	BS7205	31126750057S1	CJ142	31126751318
CJ1034	4D0407509D	CTR5491	4F0419811E	BS7205	31126750221	CJ142	31126752718
CJ1034	4D0407509K	CTR5491	4F0498811	BS7205	31126750222	CJ142	31126758520
CJ1035	4D0407510B	CTR5491	8E0419811B	BS7205	31126751372	CJ142	31126770248
CJ1035	4D0407510D	CTR5605	6Q0411315A	BS7205	31126751435	CJ142	31126774820
CJ1035	4D0407510K	CTR5605	6Q0411315B	BS7205	31126751436	CJ142	31126777852
CJ1175	8E0407151E	CTR5605	6Q0411315C	BS7205	31126753058	CJ143	31121094465
CJ1175	8E0407151K	CTR5605	6Q0411315D	BS7205	31126753059	CJ143	31121096985
CJ1175	8E0407151L	CTR5605	6Q0411315E	BS7205	31126753060	CJ143	31126750223
CJ1175	8E0407151M	CTR5605	6Q0411315F	BS7205	31126754547	CJ143	31126751317
CJ1175	8E0407151N	CTR5605	6Q0411315G	BS7205	31126754899	CJ143	31126752717
CJ1175	8E0407151R	CTR5605	6Q0411315H	BS7205	31126754900	CJ143	31126758519
CJ287	8D0407505B	CTR5605	6Q0411315J	BS7205	31126757623	CJ143	31126770247
CJ287	8D0407505F	CTR5605	6Q0411315L	BS7205	31129071663	CJ143	31126774819
CJ287	8D0407505H	CTR5605	6Q0411315M	BS7205	31129071952	CJ143	31126777851
CJ287	8D0407505K	CTR5605	6Q0411315N	BS7205	31129071963	CJ847	31121126254
CJ287	8E0407505A	CTR5605	6Q0411315P	CJ1065L	31121092023	CJ848	31121126253
CJ292	4D0407693AC	CTR5605	6R0411315	CJ1065L	31121141717	CJ848	31121126296
CJ292	4D0407693AD	CTR5605	6R0411315A	CJ1065R	31121092024	CJ848	31121139131
CJ292	4D0407693E	CTR5605	8Z0411315D	CJ1065R	31121141718	CJ863	31121096685
CJ292	4D0407693H	CTR5706L	1J0422811B	CJ1066L	31121093449	CJ863	31121140398
CJ292	4D0407693K	CTR5706R	1J0422812B	CJ1066L	31121093450	CJ863	31126758510
CJ292	4D0407693M	CTR5849	1K0411315B	CJ1066L	31121094233	CJ870L	31121094275
CJ292	4D0407693N	CTR5849	1K0411315D	CJ1066R	31121093450	CJ870L	31121136529
CJ292	8E0407693E	CTR5849	1K0411315G	CJ1066R	31121094234	CJ870L	31121140399
CJ293	4D0407694AC	CTR5849	1K0411315J	CJ1149	31122405861	CJ870L	31121140957
CJ293	4D0407694AD	CTR5849	1K0411315K	CJ1149	31122409599	CJ870L	31126758513
CJ293	4D0407694E	CTR5849	1K0411315N	CJ1149	31124036269	CJ870L	31126758515
CJ293	4D0407694H	CTR5849	1K0411315P	CJ1149	31126763703	CJ870R	31121094276
CJ293	4D0407694K	CTR5849	1K0411315R	CJ1149	31126763707	CJ870R	31121136530
CJ293	4D0407694M	MO6180	1J0412331	CJ1149	31126769797	CJ870R	31121140400
CJ293	4D0407694N	MO6180	1J0412331B	CJ1149	31126769801	CJ870R	31121140958

ORIGINAL-NO.

BMW

CJ870R	31126758514
CJ870R	31126758516
CTR5159	31351091764
CTR5159	31351127689
CTR5159	31351128737
CTR5380	31351124380
CTR5380	31351127194
CTR5380	31351128050
CTR5380	31351130075
CTR5380	31351134582
CTR5380	31352227203
CTR5605	31351095694
CTR5605	31356780847
CTR5875L	31356765933
CTR5875R	31356765934
RE046	32111139315PART
RE046	32111139316PART
RE5472	32111127124
RE5472	32111130449
RE5489	32111139318PART
RE5549	32111091767*
RE5549	32111091767PART
RE5549	32111091768*
RE5549	32111091768PART
RE5604	32111096897PART
RE5843	32216762243
RE5843	32216762244
RE5845	32106774347PART
RE5845	32106777479PART
RE5845	32216762403PART

CHEVROLET

BS8315	96535088
BS8315	96653381
CJ1089	90487561
CJ1089	90512982
CJ1089	90542995
CJ269L	96535081
CJ269L	96815893
CJ269L	96870465
CJ269R	96535082
CJ269R	96815894
CJ269R	96870466
CJ951	90141393
CJ951	90295479
CJ951	90297863
CTR5170	26059294
CTR5170	9118127
CTR5170	93186537
CTR5506	26011925
CTR5506	26087868
CTR5506	93192419
CTR5771	90496116

CHEVROLET

CTR5891	96391875
CHRYSLER	
CJ1028	5099237AA
CTR5927	68020845AA
CTR5927	68047089AA
CTR6107	04797706
CTR6107	4797706
RE5928	68020843AA

CITROËN

CTR6130	508750
---------	--------

DAEWOO

BS8315	96535088
BS8315	96653381
CJ269L	96535081
CJ269L	96815893
CJ269L	96870465
CJ269R	96535082
CJ269R	96815894
CJ269R	96870466
CJ869	1603302
CTR5141	96129753
CTR5141	96205809
CTR5141	96446586
CTR5141	D96205809
CTR5891	96275798
CTR5891	96391875
CTR5891	D96275798
CTR5891	D96391875

FIAT

CJ1045	46543045
CTR5401	05958246
CTR5401	5958246
CTR5401	5958247
CTR5401	5983404
CTR5401	5983406
CTR5401	SE127162410A
MO5809	05960254
MO5809	5960254

FORD

BS6496	1010037
BS6496	1055191
BS6496	1E0034153A
BS6496	96FB3063AA
BS6496	96FB3063AB
BS6496	98FB3063AA
BS7411	1004011
BS7411	1014654
BS7411	1063372
BS7411	1E0134153A
BS7411	96FB3A262AD
BS7411	98FB3A262AA
CJ1205	UR6134550

FORD

CJ124	1058279
CJ124	6525743
CJ124	6525843
CJ124	6615742
CJ124	6732630
CJ124	6770224
CJ124	7102644
CJ124	7351747
CJ124	91AB3042AB
CJ124	91AB3042AD
CJ124	92AB3042AA
CJ124	92AB3042BA
CJ124	94AB3042AA
CJ124	95AB3042AB
CJ124	95AB3042AE
CJ125	1058280
CJ125	6525844
CJ125	6615743
CJ125	6732631
CJ125	6770225
CJ125	7102645
CJ125	7351748
CJ125	91AB3051AD
CJ125	92AB3051AA
CJ125	92AB3051BA
CJ125	94AB3051AA
CJ125	95AB3051AB
CJ125	95AB3051AD
CJ125	95AB3051AE
CJ1259	1470387
CJ1259	1679388
CJ1259	3M513K209BA
CJ1259	6829045
CJ1259	93BB5K653AB
CJ1259	ME4M5J3395AA
CJ159L	1003584
CJ159L	1003585
CJ159L	1009594
CJ159L	1009596
CJ159L	1015264
CJ159L	1017014
CJ159L	1021220
CJ159L	1045656
CJ159L	1046282
CJ159L	1046285
CJ159L	1063255
CJ159L	96FB3051BF
CJ159L	96FB3051BG
CJ159L	98FB3051CC
CJ159R	1003574
CJ159R	1003575
CJ159R	1009580

FORD

CJ159R	1009584
CJ159R	1015260
CJ159R	1017013
CJ159R	1021219
CJ159R	1045655
CJ159R	1046280
CJ159R	1046283
CJ159R	1063236
CJ159R	96FB3042BF
CJ159R	96FB3042BG
CJ159R	98FB3042CC
CJ582	1030025
CJ582	1030026
CJ582	1047797
CJ582	1047798
CJ582	7152281
CJ582	94FB3395A2A
CJ582	94FB3395A2B
CJ582	94FB3B376AA
CJ843	3240196
CJ843	3246130
CJ843	5021456
CJ843	6084942
CJ843	6087888
CJ843	6115333
CJ843	6115334
CJ843	81AB3A052AC
CJ843	86AB3078A2A
CJ844	3240197
CJ844	3246129
CJ844	5021457
CJ844	6084943
CJ844	6087889
CJ844	6115335
CJ844	6115336
CJ844	81AB3A053AC
CJ919	K9597
CJ964	1637182
CJ964	1637183
CJ964	5021458
CJ964	880X3B376CA
CJ965	1637184
CJ965	1637185
CJ965	5021459
CJ965	86AB3079A1A
CJ965	86AB3079A2A
CJ983	8AU334510
CTR1418	1513343
CTR1418	1745924
CTR1418	1790310
CTR1418	1905043
CTR1418	8V513B438AB

ORIGINAL-NO.

FORD

CTR1418	8V513B438BA
CTR1418	8V513B438BB
CTR1418	8V513B438BC
CTR5308	1454896
CTR5318	1004018
CTR5318	1061631
CTR5318	1067818
CTR5318	1130273
CTR5318	1135077
CTR5318	1661237
CTR5318	1E0034170
CTR5318	1S613B438AA
CTR5318	6186082
CTR5318	6188004
CTR5318	6198621
CTR5318	89FB3B438A1E
CTR5318	96FB3B438AB
CTR5318	98AG3B438AB
CTR5318	YS413B438BA
CTR5335	3669093
CTR5335	XM343289BA
CTR5921L	1315083
CTR5921R	1315074
CTR5923	1223792
CTR5923	1230909
CTR5923	3M513B438AB
CTR5984	UR5632250
CTR6172	1146150
CTR6172	1469212
CTR6172	1761200
CTR6172	2S613B438AC
CTR6172	2S613B438AD
CTR6172	2S613B438AE
CTR6191	1310333
CTR6191	1335548
CTR6191	1469208
RE5407	6131083
RE5407	6134277
RE5407	6185335
RE5407	6185336
RE5407	83BB3L519EA
RE5407	87BB3L519DA
RE5407	87BB3L519EA
RE5450	6135757
RE5450	6185338
RE5450	87GB3L519BA
RE5571	4342539
RE6092	1545457
RE6092	8V513L519AA

FOTON

CTR5005A	4504629325
RE188	4550329565

GONOW

CJ933	4335039035
CJ934	4333039165

GWM

CJ933	4335039035
CJ934	4333039165

HOLDEN

CJ1089	90487561
CJ1089	90512982
CJ1089	90542995
CJ951	90141393
CJ951	90295479
CJ951	90297863
CTR5771	90496116

HONDA

CJ610L	51460S01023
CJ610R	51450S01023
CJ962	51220SA0A01
CJ962	51220SB0003
CJ962	51220SE0000
CJ962	51220SE0003
CJ962	51220SF1000
CJ962	51220SF1100
CJ962	51220SH3003
CJ962	51220SK7003
CJ962	51220SK7013
CJ962	51220SM0A01
CTR5345L	53560SH3003
CTR5345L	53560SH3013
CTR5345R	53540SH3003
CTR5345R	53540SH3013
CTR5552	51320S04003
RE071	53010SR3010
RE5908	53010S04000

HYUNDAI

BS7860	545842E000
CJ1011	5450322A00
CJ1011	5450331600
CJ1011	5452031600
CJ1011	5453014200
CJ1011	5453031600
CTR3107	5553029000
CTR3107	5553029500
CTR3107	5553029500AS
CTR5474	5682025000
CTR5474	5682028520
CTR5474	5682037010
CTR5474	5685028520
CTR5567	568203B000
CTR5915L	548301C000
CTR5915R	548401C000
CTR6032	5483029000
RE6055	577240X000

ISUZU

CJ1221	898005827051
CJ930	8944594532
CJ930	8944594533
CJ930	8944594534
CJ936	89444594642
CJ936	8944594641
CJ936	8944594642
CJ936	94459464
CJ946	8944521020
CJ946	8944521021
CJ946	8944594651
CJ946	8944594652
CJ946	94452102
CTR5331L	8944194090
CTR5331L	8944194091
CTR5331L	8944594810
CTR5331L	8944594812
CTR5331R	324057
CTR5331R	8944194080
CTR5331R	8944194081
CTR5331R	8944594800
CTR5331R	8944594802
CTR5331R	920373
CTR5331R	94419408
CTR5331R	94459480
CTR5806	897304855051
CTR6182L	8979445690
CTR6182R	8979445680

KIA

BS7860	545842E000
--------	------------

MAZDA

BS6496	1010037
BS6496	1055191
BS6496	1E0034153A
BS7411	1014654
BS7411	1063372
BS7411	1E0134153A
CJ1199	GJ6A34300B
CJ1199	GJ6A34300C
CJ1199	GJ6A34300D
CJ1205	UR6134550
CJ159L	1E0034350A
CJ159L	1E0134350A
CJ159R	1E0034300A
CJ159R	1E0134300A
CJ294L	B32H34350
CJ294L	B32H34350A
CJ294L	B32H34350B
CJ294L	B32H34350C
CJ294L	B32H34350D
CJ294L	B32H34350E
CJ294L	B37F34350

MAZDA

CJ294L	B37F34350A
CJ294L	B37F34350B
CJ294L	BP4K34350
CJ294L	BP4K34350A
CJ294L	BP4K34350B
CJ294L	BP4K34350C
CJ294L	BP4K34350D
CJ294L	BP4K34350E
CJ294L	C51334350
CJ294L	CC3034350
CJ294L	CC3034350A
CJ294L	CC3034350B
CJ294L	CC3034350C
CJ294L	CC3034350D
CJ294L	CC3034350E
CJ294R	B32H34300
CJ294R	B32H34300A
CJ294R	B32H34300B
CJ294R	B32H34300C
CJ294R	B32H34300D
CJ294R	B32H34300E
CJ294R	B37F34300
CJ294R	B37F34300A
CJ294R	B37F34300B
CJ294R	BP4K34300
CJ294R	BP4K34300A
CJ294R	BP4K34300B
CJ294R	BP4K34300C
CJ294R	BP4K34300D
CJ294R	BP4K34300E
CJ294R	BP4K34300E
CJ294R	C51334300
CJ294R	CC3034300
CJ294R	CC3034300A
CJ294R	CC3034300B
CJ294R	CC3034300C
CJ294R	CC3034300D
CJ294R	CC3034300E
CJ582	94FB3395A2B
CJ919	K9597
CJ926	B00134550
CJ926	B09234550
CJ983	8AU334510
CTR1418	D65134170
CTR1418	D65134170A
CTR5184	8AB032280
CTR5184	8AB232280
CTR5184	B45532280
CTR5308	6M343280AA
CTR5318	1130273
CTR5318	1E0034170
CTR5335	8AU132280
CTR5335	UH7432280

ORIGINAL-NO.

ORIGINAL-NO.

MAZDA

CTR5527	LC6234170
CTR5527	LC6234170B
CTR5923	BP4K34170C
CTR5984	UR5632250
CTR6172	DD3234170
CTR6172	DD3234170A
CTR6172	DD3234170B
CTR6191	1335548
CTR6191	BP4K28170C
CTR6191	BP4K28170D
RE014	B09232240
RE014	BF6232240
RE014	BF6732240
RE014	BF673224X
RE5946	BP4L32240
RE5948	GJ6A32240
RE6092	D65132240

MERCEDES-BENZ

CJ1028	2023330027
CJ1028	2103300035
CJ1028	2103330427
CJ1028	2113300335
CJ1028	2203300635
CJ1143	1693330127
CJ1193	2113300235
CJ1193	2113300435
CJ1193	2203330127
CJ1193	2203330227
CJ1193	2203330327
CJ1193	2203330427
CJ1193	2203330727
CJ996L	2033301911
CJ996L	2033303311
CJ996L	2043301911
CJ996R	2033302011
CJ996R	2033303411
CJ996R	2043302011
CJ997L	2033300111
CJ997L	2033301611
CJ997L	2033303511
CJ997L	2033303911
CJ997L	2043304311
CJ997R	2033300211
CJ997R	2033301711
CJ997R	2033303611
CJ997R	2033304011
CJ997R	2043304411
CTR5172	1233380210
CTR5497	0013307435
CTR5497	0013307735
CTR5542	9014600048
CTR5542	9014600148

MERCEDES-BENZ

CTR5542	9014600248
CTR5542	9014600348
CTR5781L	2033301903
CTR5781L	2033303903
CTR5783	2033200489
CTR5783	2033202589
CTR5783	2033202889
CTR5927	90610481001
CTR5927	90610481003
CTR5927	9064600048
CTR5927	9064600148
CTR5927	9064600348
CTR6047R	2043201889
RE5444	2103380415
RE5782	2203380715
RE5782	2303380015
RE5928	90610551003
RE5928	9064600055

MINI

CTR5380	31351130075
CTR5380	31351134582

MITSUBISHI

CJ904	MB860829
CJ904	MB860830
CJ961L	MB831037
CJ961L	MR296269
CJ961R	MB831038
CJ961R	MR296270
CTR5556	MB831044
CTR5557	MB831043

NISSAN

BS8131	5461600QAA
BS8147	54500AX600
BS8147	54500BC41A
BS8147	54500BC42A
BS8147	54501AX600
BS8147	54501BC41A
BS8147	54501BC42A
BS8147	54560AX600
BS8218	54500AX600
BS8218	54501AX600
BS8218	54560AX600
BS8218	54570AX600
CJ787	40160B1001
CJ912	4016001G00
CJ912	4016001G25
CJ912	4016001G50
CJ912	4016001G90
CJ912	4016001N25
CTR1366L	48641H1001
CTR1366L	48641H5025
CTR1366L	48641W5025

NISSAN

CTR1366R	48521H1001
CTR1366R	48521H5025
CTR1366R	48521W5025
CTR1367L	48640H1001
CTR1367R	48520H1001
CTR5309	4852131G25
CTR5309	4857031G25
CTR5310	4852101G25
CTR5559	5461850Y00
CTR5559	5461858820
CTR5559	54618D5000
CTR5559	54618D5010
CTR5600	D8520VK91A
CTR5601	485212S425
CTR5675L	546688H300
CTR5675R	546188H300
CTR5682	546184M400
CTR5699	485703S500
CTR5700	485200W025
CTR5770	54618AX600
CTR6150L	54668EA010
CTR6150L	54668EB30A
CTR6150R	54618EA010
CTR6150R	54618EB30A
RE053	4852150400
RE053	4852150Y00
RE5990	485213U025

OPEL

BS6102	352309
BS6103	352310
BS6103	352320
BS6383	0352347
BS6383	0352348
BS6383	0352352
BS6383	352347
BS6383	352348
BS6383	352352
BS6383	90268463
BS6383	90288082
BS6406	0352300
BS6406	0352346
BS6406	0352351
BS6406	352300
BS6406	352346
BS6406	352351
BS6406	90288232
BS6406	90373778
CJ1089	352800
CJ1089	352829
CJ1089	352830
CJ1501L	0352074
CJ1501L	0352075

OPEL

CJ1501L	0352077
CJ1501L	0352143
CJ1501L	0352163
CJ1501L	0352193
CJ1501L	352074
CJ1501L	352075
CJ1501L	352077
CJ1501L	352143
CJ1501L	352163
CJ1501L	352193
CJ1501L	5352001
CJ1501L	5352015
CJ1501L	90373779
CJ1501L	90473226
CJ1501L	90495103
CJ1501L	90495159
CJ1501R	0352076
CJ1501R	0352192
CJ1501R	352076
CJ1501R	352192
CJ1501R	5352000
CJ1501R	90473227
CJ1501R	90495104
CJ1501R	90495160
CJ654	352803
CJ869	025260037576
CJ869	1603202
CJ869	1603302
CJ869	1603302
CJ869	90539896
CJ930	310821
CJ946	0352822
CJ946	0352828
CJ946	352822
CJ946	352828
CJ946	8944594652
CJ946	94459465
CJ951	1603121
CJ951	1603163
CJ951	1603167
CTR2462	350611
CTR2462	350614
CTR5170	1603214
CTR5170	1603215
CTR5170	1603542
CTR5331L	0920374
CTR5331L	920374
CTR5331L	94459481
CTR5331R	0920373
CTR5331R	920373
CTR5427L	0324053
CTR5427L	0324055
CTR5427L	324053

ORIGINAL-NO.

OPEL

CTR5427L	324055
CTR5427R	0324054
CTR5427R	0324056
CTR5427R	324054
CTR5427R	324056
CTR5500	1603455
CTR5500	324066
CTR5506	1603009
CTR5506	1603645
CTR5506	324050
CTR5643	350263
CTR5771	350610
MO6848	0344523
MO6848	344523
MO6848	90468554
RE056	1603018
RE056	1603843
RE5499	1603008
RE5499	1603845
RE5547	1603213
RE5547	1603216
RE5547	1603287
RE5547	1603303
RE5815	0322158
RE5815	322158

PEUGEOT

CTR6130	508750
CTR6130	96347856
RE5651	3812C5

PORSCHE

CJ108	171407153D
CJ108	171407181APART
CJ108	171407182DPART
CJ832	171407365F
CJ832	171407365G
CTR5140	171419811

RENAULT

BS6002	7700418941
BS6002	7700419236
BS6002	7700419249
BS6002	7700424399
BS6819	8200041166
BS8131	7700799404
BS8147	8200183569
BS8147	8200346941
BS8147	8200346942
BS8218	8200183570
BS8218	8200346941
BS8218	8200346942
BS8218	8200696437
CJ1145	8200298454PART
CJ1145	8200298455PART

RENAULT

CJ1145	8200346941
CJ1145	8200346942
CJ1145	8200457209
CJ1145	8200615057
CJ1145	8200615058
CJ1145	8200679067
CJ1145	8200744091
CJ1145	8200744092
CJ299L	8200346941
CJ299L	8200615057
CJ299L	8200744091
CJ299R	8200346942
CJ299R	8200615058
CJ299R	8200744092
CTR5726L	7701047415
CTR5726L	7701047812
CTR5726L	7701474492
CTR5726L	7701475842
CTR5726L	7701476760
CTR5726L	7701476762
CTR5726R	7701047416
CTR5726R	7701047813
CTR5726R	7701474493
CTR5726R	7701475843
CTR5726R	7701476761
CTR5726R	7701476763
CTR5770	8200127308
CTR5985L	6001547610
CTR5985L	6001550442
CTR5985R	6001547611
CTR5985R	6001550443
RE5902	7701474448
RE5986	6001547606
RE5986	6001550441

SAAB

CJ1089	4835740
CJ1089	5231683
CJ1089	93185278
CTR5427L	4242749
CTR5427R	4242756
CTR5643	30540743
CTR5643	4400040
CTR5643	4544599
CTR5771	4686606
CTR5771	5236823

SUBARU

CTR0300	20470SA010
CTR0300	20470SA011

SUZUKI

CJ1084	4520069D00
CJ1084	4520084000

TOYOTA

TOYOTA

BS6455	4865512120
BS8424	4865507010
BS8424	4865533010
CJ1168L	
CJ1168R	
CJ1169	
CJ1170L	
CJ1170R	
CJ1187	4333009295
CJ1187	4333009490
CJ1187	4333009510
CJ1188	
CJ266L	4806902020
CJ266L	4806902021
CJ266L	4806902030
CJ266L	4806902070
CJ266L	4806902080
CJ266L	4806912220
CJ266L	4806912260
CJ266L	4806913010
CJ266R	4806802020
CJ266R	4806802021
CJ266R	4806802030
CJ266R	4806802070
CJ266R	4806802080
CJ266R	4806812220
CJ266R	4806812260
CJ266R	4806813010
CJ281	4333029175
CJ914	4334019015
CJ914	4334019016
CJ915	4333019065
CJ915	4333019066
CJ931	4333029125
CJ931	4334029105
CJ932	4335029045
CJ932	4335029056
CJ932	4336029065
CJ932	4336029076
CJ933	4335039035
CJ934	4333039165
CJ935	4333029135
CJ935	4333029136
CJ935	4333029137
CJ935	4333029138
CJ935	4333029139
CJ935	4333029140
CJ935	4333029205
CJ949	4333009070
CJ949	4333009090
CJ949	4333009230
CJ949	4333009640

TOYOTA

CJ949	4333019115
CJ949	4333049045
CJ949	4333069015
CJ981	4335039045
CJ981	4336039085
CJ984	4335029065
CJ984	4335029095
CTR5005	4504629215
CTR5005	4504660081
CTR5005	4504669055
CTR5005A	4504629325
CTR5300	4504629115
CTR5300	4504629125
CTR5300	4504639105
CTR5300	4504639106
CTR5300	4504639125
CTR5300	4504639165
CTR5300	4504639175
CTR5300	4504639215
CTR5300	4504639235
CTR5300	4504639355
CTR5300	4504639375
CTR5300	4504639385
CTR5301	4540629115
CTR5317	4540629145
CTR5317	4540629175
CTR5343A	4504619175
CTR5343A	4504629305
CTR5429L	4504609020
CTR5429L	4504629255
CTR5470R	4504609360
CTR5470R	4504619265
CTR5470R	4504649115
CTR5534	4883020010
CTR5812	4504629456
CTR5916	4882047010
CTR6115	488200K010
CTR6160	4882042030
CTR6211	48820B0010
RE030	4550319125
RE049	4550319116
RE049	4550329255
RE188	4550329565
RE188	4550329565
RE2406	4550312130
RE5463	4550319215
RE5957	4550002130
RE5957	4550002300
RE5957	4551012390
RE5975	4550349105

VOLVO

CJ1259	31201180
--------	----------

ORIGINAL-NO.

VOLVO

CJ1259	31201181
CTR5140	032119554
CTR5140	3211955
CTR5140	3265974
CTR5774	274303
CTR5774	274456
CTR5774	30714685
CTR5774	8634736
CTR5774	8672445
CTR5921L	1315083
CTR5921L	1317447
CTR5921L	1328881
CTR5921L	274500
CTR5921L	30723103
CTR5921R	1315074
CTR5921R	1317446
CTR5921R	1328877
CTR5921R	274501
CTR5921R	30723104
CTR5923	8623576
CTR6015	30884179
CTR6191	30683232
CTR6191	30714466
CTR6191	31212548

VW

BS6417	1J0407181
BS6883	1K0199231G
BS6883	1K0199231J
BS6883	1K0199231P
BS6884	1K0199232G
BS6884	1K0199232J
BS6884	1K0199232P
BS6899	1K0407182
BS6899	1K0407182A
BS6911	191407182
BS6911	357407182
BS7069	4D0407183D
BS7069	4D0407183M
BS7069	4D0407183N
BS7069	4D0407183P
BS7069	4D0407183Q
BS7072	4D0407515
BS7072	4D0407515C
BS8271	7H0407182A
BS8272	2H0407183A
BS8272	7H0407183
CJ1031	1H0407365
CJ1033	8D0407506B
CJ1033	8D0407506F
CJ1033	8D0407506H
CJ1033	8D0407506K
CJ1034	4D0407509B

VW

CJ1034	4D0407509D
CJ1035	4D0407510B
CJ1035	4D0407510D
CJ108	171407153D
CJ108	171407181APART
CJ108	171407182DPART
CJ1090	5Z0407365B
CJ1090	6Q0407365A
CJ1090	6Q0407365M
CJ1091	5Z0407366B
CJ1091	6Q0407366A
CJ1091	6Q0407366M
CJ111L	1H0407151
CJ1163	7E0407361
CJ1163	7H0407361
CJ1163	7H0407361A
CJ205L	6Q0407151D
CJ205L	6Q0407151E
CJ205L	6Q0407151L
CJ287	8D0407505B
CJ287	8D0407505F
CJ287	8D0407505H
CJ287	8D0407505K
CJ292	4D0407693E
CJ292	4D0407693H
CJ292	4D0407693K
CJ292	4D0407693M
CJ292	4D0407693N
CJ293	4D0407694E
CJ293	4D0407694H
CJ293	4D0407694K
CJ293	4D0407694M
CJ293	4D0407694N
CJ832	171407365F
CJ832	171407365G
CJ864	357407365
CJ864	357407365A
CJ957	191407365
CJ957	191407365A
CJ957	191407365B
CJ986	1J0407365A
CJ986	1J0407365C
CJ986	1J0407365D
CJ986	1J0407365H
CJ986	1J0407365J
CJ987	1J0407366A
CJ987	1J0407366C
CJ987	1J0407366D
CJ987	1J0407366H
CJ987	1J0407366J
CTR5140	171419811
CTR5140	171419811A

VW

CTR5140	171419812
CTR5140	251419811
CTR5140	32111116463
CTR5140	3211955
CTR5140	3265974
CTR5140	477419811
CTR5140	477419815
CTR5140	94434733300
CTR5191L	191419811
CTR5191L	3A0419811
CTR5191L	3A0422811
CTR5191L	6N0419811
CTR5191R	191419812
CTR5191R	3A0422812
CTR5191R	6N0419812
CTR5491	4B0419811
CTR5491	4B0419811B
CTR5491	4B0419811C
CTR5491	4B0419811D
CTR5491	4B0419811E
CTR5491	4B0419811F
CTR5491	4D0419811A
CTR5491	4D0419811B
CTR5491	4D0419811G
CTR5491	4D0419811H
CTR5491	4F0419811E
CTR5491	4F0498811
CTR5491	8E0419811B
CTR5542	2D0422811
CTR5605	6Q0411315A
CTR5605	6Q0411315B
CTR5605	6Q0411315C
CTR5605	6Q0411315D
CTR5605	6Q0411315E
CTR5605	6Q0411315F
CTR5605	6Q0411315G
CTR5605	6Q0411315H
CTR5605	6Q0411315J
CTR5605	6Q0411315L
CTR5605	6Q0411315M
CTR5605	6Q0411315N
CTR5605	6Q0411315P
CTR5605	6R0411315
CTR5605	6R0411315A
CTR5605	8Z0411315D
CTR5706L	1J0422811B
CTR5706R	1J0422812B
CTR5834L	5Z0423811
CTR5834L	6Q0423811
CTR5834L	6Q0423811A
CTR5834L	6Q0423811C
CTR5834L	6R0423811

VW

CTR5834R	5Z0423812
CTR5834R	6Q0419812C
CTR5834R	6Q0423812
CTR5834R	6Q0423812A
CTR5834R	6R0423812
CTR5849	1K0411315B
CTR5849	1K0411315D
CTR5849	1K0411315G
CTR5849	1K0411315J
CTR5849	1K0411315K
CTR5849	1K0411315N
CTR5849	1K0411315P
CTR5849	1K0411315R
CTR5927	2E0498104
CTR5927	2E0498104A
CTR5927	2E0713501
MO5414	191407181A
MO5414	191407181B
MO5414	191407181D
MO5414	191407181E
MO5414	357407181
MO6180	1J0412331
MO6180	1J0412331B
MO6180	1J0412331C
RE0185	6X0422803A/4APA
RE0185	6X0422804A
RE033	171419821
RE033	171419821A
RE5192	191419803*
RE5192	191419803PART
RE5192	191419804*
RE5192	191419804PART
RE5473	191422803APART
RE5473	191422804APART
RE5712	6Q0423803PPART
RE5718	701419804F
RE5718	701419810B
RE5718	702419803D
RE5841	1K0423810A
RE5928	2E0713491
RE8143	1J0422807B
RE8143	1J0422807E

BS5421



Height [mm] : 34
 Inner Diameter [mm] : 18
 Outer diameter [mm] : 60

BS5422



Height [mm] : 33
 Inner Diameter [mm] : 18
 Outer diameter [mm] : 60

BS6002



Height [mm] : 46
 Outer diameter 1 [mm] : 45
 Outer diameter 2 [mm] : 59

BS6102



BS6103



BS6177



Height 1 [mm] : 47
 Height 2 [mm] : 56
 Inner Diameter [mm] : 14
 Outer diameter [mm] : 58

BS6383



Height 1 [mm] : 27
 Height 2 [mm] : 58
 Inner Diameter [mm] : 16
 Outer diameter 1 [mm] : 60
 Outer diameter 2 [mm] : 66

BS6406



Inner Diameter [mm] : 12
 Outer diameter 1 [mm] : 39
 Outer diameter 2 [mm] : 44

BS6417



Height 1 [mm] : 25
 Height 2 [mm] : 41
 Inner Diameter [mm] : 13
 Outer diameter [mm] : 60

BS6496



Height 1 [mm] : 44
 Height 2 [mm] : 62
 Inner Diameter [mm] : 12
 Outer diameter 1 [mm] : 24
 Outer diameter 2 [mm] : 37

BS6819



Inner Diameter [mm] : 12
 Outer diameter [mm] : 24
 Outer diameter [mm] : 58

BS6883



BS6884



BS6899



BS6911



Height [mm] : 54
 Inner Diameter [mm] : 12
 Outer diameter 1 [mm] : 33
 Outer diameter 2 [mm] : 36

BS7069



Height 1 [mm] : 66
 Height 2 [mm] : 80
 Inner Diameter [mm] : 12
 Outer diameter [mm] : 65

PICTURES

BS7072



Height 1 [mm] : 26
 Height 2 [mm] : 40
 Inner Diameter [mm] : 10
 Outer diameter 1 [mm] : 24
 Outer diameter 2 [mm] : 46

BS7204



Diameter [mm] : 66

BS7205



Diameter [mm] : 66

BS7411



Height [mm] : 50
 Inner Diameter [mm] : 12
 Outer diameter [mm] : 66

BS7860



Height 1 [mm] : 60
 Height 2 [mm] : 36.7
 Inner Diameter [mm] : 14.1
 Outer diameter [mm] : 66.4

BS8131



Inner Diameter [mm] : 12
 Outer diameter [mm] : 40

BS8147



BS8218



Height [mm] : 53
 Inner Diameter [mm] : 12
 Outer diameter [mm] : 58

BS8271



BS8272



Height [mm] : 60.3
 Inner Diameter [mm] : 14.1
 Outer diameter 1 [mm] : 51.5
 Outer diameter 2 [mm] : 40.3

BS8315



Height [mm] : 46
 Inner Diameter [mm] : 12
 Outer diameter [mm] : 60

BS8424



Height [mm] : 62.6
 Inner Diameter [mm] : 14.3
 Outer diameter [mm] : 60.3

CJ1011



Cone Pitch : 1/8
 Cone Size [mm] : 15

CJ1028



Cone Size [mm] : 16
 Outer thread [mm] : M14 x 1,50

CJ1031



Cone Size [mm] : 16.5
 Outer thread [mm] : M12 x 1,50

CJ1033



Cone Size [mm] : 15.9
 Length [mm] : 278

CJ1034



Length [mm] : 249

CJ1035



Length [mm] : 251

CJ1045



CJ1065L



Cone Size [mm] : 14
Length [mm] : 430

CJ1065R



Cone Size [mm] : 14
Length [mm] : 430
Outer thread [mm] : M14 x 1,25

CJ1066L



Cone Size [mm] : 14.2
Length [mm] : 315

CJ1066R



Cone Size [mm] : 14.2
Length [mm] : 315

CJ108



CJ1084



CJ1089



Cone Size [mm] : 18

CJ1090



Cone Size [mm] : 14,9
Outer thread [mm] : M12 x 1,50

CJ1091



Cone Size [mm] : 14,9
Outer thread [mm] : M12 x 1,50

CJ111L



CJ1143



Cone Size [mm] : 15,5
Outer thread [mm] : M14 x 1,50

CJ1145



Outer diameter 1 [mm] : 38,3
Outer diameter 2 [mm] : 46

CJ1149



PICTURES

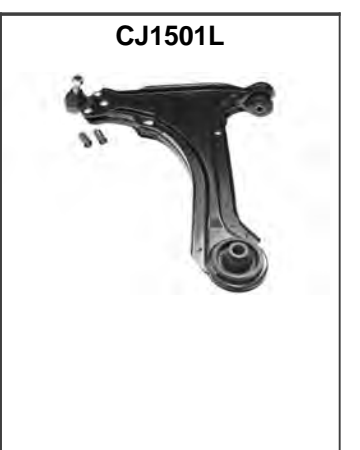
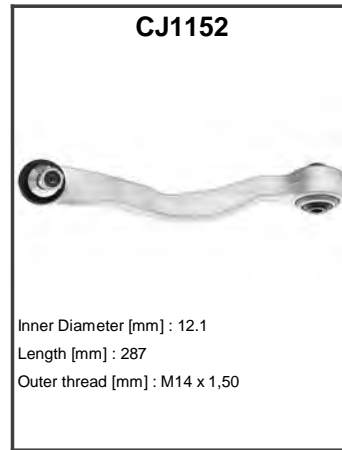
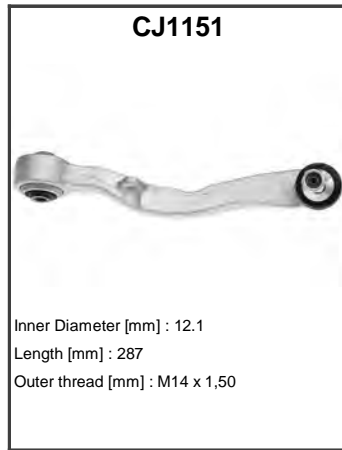
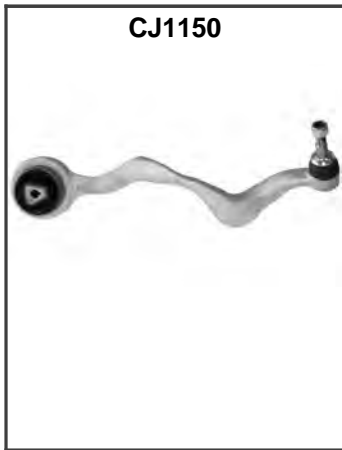

CJ1501R



CJ159L



CJ159R



CJ205L



CJ266L



CJ266R



CJ269L



Thread Size : M12x1.25

CJ269R



Thread Size : M12x1.25

CJ281



Cone Pitch : 1/8
Cone Size [mm] : 16.8

CJ287



Cone Size [mm] : 16
Length [mm] : 276

CJ292



Cone Size [mm] : 15.4
Length [mm] : 385

CJ293



Cone Size [mm] : 15.4
Length [mm] : 385

CJ294L



CJ294R



CJ299L



CJ299R



PICTURES



CJ870R



CJ877



CJ904



Cone Pitch : 1/8
Cone Size [mm] : 15.9

CJ912



Cone Size [mm] : 19.6
Outer thread [mm] : M18 x 1,50

CJ914



Cone Size [mm] : 15.53
Inner Thread [mm] : M12 x 1,25
Outer thread [mm] : M14 x 1,50

CJ915



Cone Size [mm] : 15.53
Inner Thread [mm] : M12 x 1,25
Outer thread [mm] : M14 x 1,50

CJ918



Cone Pitch : 1/8
Cone Size [mm] : 13.7
Diameter 1 [mm] : 13

CJ919



CJ926



Cone Size [mm] : 16

CJ930



Cone Size [mm] : 17.5
Outer thread [mm] : M14 x 1,50

CJ931



Cone Size [mm] : 18.2

CJ932



Cone Size [mm] : 17

CJ933



CJ934



CJ935



Cone Size [mm] : 15.5
Outer thread [mm] : M14 x 1,50

CJ936



PICTURES



CJ996R



CJ997L



CJ997R



CTR0300



CTR1367L



CTR1367R



CTR1418



Length [mm] : 250.5
Outer thread 1 [mm] : M10 x 1,50
Outer thread 2 [mm] : M10 x 1,50

CTR2462



Length [mm] : 300

CTR3107



CTR5005



Cone Size [mm] : 14.6
Inner Thread [mm] : M17 x 1,50
Length [mm] : 121
Outer thread [mm] : M14 x 1,50

CTR5005A



CTR5140



Cone Pitch : 1/10
Cone Size [mm] : 12.7
Inner Thread [mm] : M14 x 1,50
Length [mm] : 75

CTR5141



Cone Pitch : 1/8
Cone Size [mm] : 13.3
Inner Thread [mm] : M14 x 1,50
Length [mm] : 74

CTR5159



Diameter [mm] : 10
Length [mm] : 70

CTR5170



Cone Size [mm] : 13.3
Inner Thread [mm] : M14 x 1,50
Length [mm] : 134

CTR5172



Cone Size [mm] : 12.6
Length [mm] : 95
Outer thread 1 [mm] : M10 x 1,25
Outer thread 2 [mm] : M16 x 1,50 LHT M

PICTURES

CTR5184



Cone Size [mm] : 13.23
 Inner Thread [mm] : M12 x 1,25
 Length [mm] : 74

CTR5191L



Cone Size [mm] : 12.8
 Inner Thread [mm] : M14 x 1,50
 Length [mm] : 74.9

CTR5191R



Cone Size [mm] : 12.8
 Inner Thread [mm] : M14 x 1,50
 Length [mm] : 74.9

CTR5300



Cone Pitch : 1/10
 Cone Size [mm] : 14.5
 Length [mm] : 90
 Outer thread [mm] : M17 x 1,50 LHT M

CTR5301



CTR5308



CTR5309



Cone Pitch : 1/8
 Cone Size [mm] : 13.3
 Length [mm] : 128
 Outer thread [mm] : M16 x 1,50 LHT M

CTR5310



Cone Pitch : 1/8
 Cone Size [mm] : 13.425
 Length [mm] : 220
 Outer thread [mm] : M18 x 1,50

CTR5317



Cone Pitch : 1/10
 Cone Size [mm] : 14.2
 Length [mm] : 270
 Outer thread [mm] : M17 x 1,50

CTR5318



Length [mm] : 239
 Outer thread [mm] : M10 x 1,25

CTR5331L



Cone Size [mm] : 16.2
 Inner Thread [mm] : M14 x 1,50 LHT F
 Length [mm] : 75

CTR5331R



Cone Size [mm] : 16
 Inner Thread [mm] : M14 x 1,50

CTR5335



Cone Size [mm] : 13.85
 Inner Thread [mm] : M14 x 1,50 LHT F
 Length [mm] : 85

CTR5338



Cone Pitch : 1/8
 Cone Size [mm] : 13.5
 Inner Thread [mm] : M14 x 1,50
 Length [mm] : 157

CTR5339



Cone Pitch : 1/8
 Cone Size [mm] : 13.25
 Inner Thread [mm] : M14 x 1,50 LHT F
 Length [mm] : 84.5

CTR5343A



Cone Pitch : 1/6
 Cone Size [mm] : 12.5
 Inner Thread [mm] : M14 x 1,50
 Length [mm] : 83

CTR5345L



Cone Pitch : 1/10
Cone Size [mm] : 12.7
Inner Thread [mm] : M14 x 1,50
Length [mm] : 180

CTR5345R



Cone Size [mm] : 13
Inner Thread [mm] : M14 x 1,50
Length [mm] : 180

CTR5380



Length [mm] : 240

CTR5401



Cone Pitch : 1/10
Cone Size [mm] : 11.95
Inner Thread [mm] : M12 x 1,50
Length [mm] : 127

CTR5427L



Cone Size [mm] : 13.2
Inner Thread [mm] : M16 x 2,00
Length [mm] : 67

CTR5427R



Cone Size [mm] : 13.2
Inner Thread [mm] : M16 x 2,00 LHT F
Length [mm] : 67

CTR5429L



Cone Size [mm] : 12.5
Inner Thread [mm] : M15 x 1,50
Length [mm] : 88

CTR5470L



Cone Size [mm] : 12.55
Length [mm] : 163

CTR5470R



Cone Size [mm] : 12.55
Length [mm] : 163

CTR5474



Inner Thread [mm] : M14 x 1,50

CTR5491



Inner Thread [mm] : M8 x 1,25
Length [mm] : 156
Outer thread [mm] : M14 x 1,50

CTR5497



Cone Pitch : 1/10
Cone Size [mm] : 14.6
Inner Thread [mm] : M12 x 1,50
Length [mm] : 72

CTR5500



Cone Size [mm] : 10.6
Inner Thread [mm] : M12 x 1,50
Length [mm] : 80

CTR5506



Cone Size [mm] : 10.6
Inner Thread [mm] : M12 x 1,50
Length [mm] : 67
Outer thread [mm] : M10 x 1,25

CTR5534



CTR5542



Cone Size [mm] : 18.1
Inner Thread [mm] : M16 x 1,50
Length [mm] : 78
Outer thread [mm] : M16 x 1,50

PICTURES

CTR5552



CTR5556



Cone Pitch : 1/10
 Cone Size [mm] : 13.6
 Length [mm] : 171
 Outer thread [mm] : M16 x 1,50

CTR5557



Cone Pitch : 1/8
 Cone Size [mm] : 13.65
 Length [mm] : 110
 Outer thread [mm] : M16 x 1,50 LHT M

CTR5559



Length [mm] : 85

CTR5567



Cone Size [mm] : 13,4
 Inner Thread [mm] : M14 x 1,50
 Length [mm] : 72
 Outer thread [mm] : M10 x 1,25

CTR5601



CTR5605



Length [mm] : 271
 Outer thread 1 [mm] : M10 x 1,50
 Outer thread 2 [mm] : M10 x 1,50

CTR5643



Length [mm] : 87
 Outer thread [mm] : M12 x 1,50

CTR5675L



CTR5675R



CTR5682



Length [mm] : 92,5
 Outer thread 1 [mm] : M10 x 1,50
 Outer thread 2 [mm] : M10 x 1,25

CTR5699



CTR5700



CTR5706L



Cone Size [mm] : 13.2
 Inner Thread [mm] : M14 x 1,50
 Length [mm] : 95

CTR5706R



Cone Size [mm] : 13.2
 Inner Thread [mm] : M14 x 1,50
 Length [mm] : 95

CTR5726L



Cone Size [mm] : 11.8
 Inner Thread [mm] : M14 x 1,50
 Length [mm] : 90

CTR5726R



Cone Size [mm] : 11.8
 Inner Thread [mm] : M14 x 1,50
 Length [mm] : 90

CTR5770



Length [mm] : 248
 Outer thread [mm] : M10 x 1,25

CTR5771



Length [mm] : 245
 Outer thread [mm] : M12 x 1,50

CTR5774



CTR5781L



Cone Size [mm] : 16.15
 Inner Thread [mm] : M14 x 1,50
 Length [mm] : 175

CTR5783



Length [mm] : 276
 Outer thread [mm] : M10 x 1,50

CTR5806



CTR5812



CTR5834L



Cone Size [mm] : 13.2
 Inner Thread [mm] : M14 x 1,50
 Length [mm] : 95

CTR5834R



Cone Size [mm] : 13.2
 Inner Thread [mm] : M14 x 1,50
 Length [mm] : 95

CTR5849



Length [mm] : 335
 Outer thread 1 [mm] : M12 x 1,50
 Outer thread 2 [mm] : M12 x 1,50

CTR5875L



Length [mm] : 290.5
 Outer thread 1 [mm] : M10 x 1,50
 Outer thread 2 [mm] : M10 x 1,50

CTR5875R



Length [mm] : 290.5
 Outer thread 1 [mm] : M10 x 1,50
 Outer thread 2 [mm] : M10 x 1,50

CTR5891



CTR5915L



Length [mm] : 202
 Outer thread [mm] : M10 x 1,25

CTR5915R



Length [mm] : 202
 Outer thread [mm] : M10 x 1,25

PICTURES

CTR5916



CTR5921L



Cone Size [mm] : 12.5
 Inner Thread [mm] : M16 x 1,5 mm RHT
 Length [mm] : 100

CTR5921R



Cone Size [mm] : 12.5
 Inner Thread [mm] : M16 x 1,5 mm RHT
 Length [mm] : 100

CTR5923



Length [mm] : 298
 Thread Size : M10 x 1,5 mm

CTR5927



Cone Size [mm] : 16.85
 Inner Thread [mm] : M16 x 1,50
 Length [mm] : 90
 Outer thread [mm] : M14 x 1,50

CTR5984



CTR5985L



Cone Size [mm] : 12
 Inner Thread [mm] : M14 x 1,5 mm RHT
 Length [mm] : 213

CTR5985R



Cone Size [mm] : 12
 Inner Thread [mm] : M14 x 1,5 mm RHT
 Length [mm] : 213

CTR6014L



Length [mm] : 139
 Outer thread 1 [mm] : M12 x 1,25
 Outer thread 2 [mm] : M12 x 1,25

CTR6014R



Length [mm] : 139
 Outer thread 1 [mm] : M12 x 1,25
 Outer thread 2 [mm] : M12 x 1,25

CTR6015



Length [mm] : 267
 Outer thread [mm] : M10 x 1,25

CTR6032



CTR6047R



Length [mm] : 306
 Outer thread 1 [mm] : M12 x 1,50
 Outer thread 2 [mm] : M12 x 1,50

CTR6107



Cone Size [mm] : 12.35
 Inner Thread [mm] : M14 x 1,50

CTR6115



CTR6130



Length [mm] : 335
 Outer thread 1 [mm] : M10 x 1,50
 Outer thread 2 [mm] : M10 x 1,50

CTR6150L



Length [mm] : 65
Outer thread 1 [mm] : M12 x 1,25
Outer thread 2 [mm] : M12 x 1,25

CTR6150R



Length [mm] : 65
Outer thread 1 [mm] : M12 x 1,25
Outer thread 2 [mm] : M12 x 1,25

CTR6160



CTR6161



Length [mm] : 360,5
Outer thread 1 [mm] : M12 x 1,25
Outer thread 2 [mm] : M12 x 1,25

CTR6172



Length [mm] : 282
Thread Size : M10 x 1,50 mm

CTR6182L



CTR6182R



CTR6191



Length [mm] : 76
Thread Size : M10 x 1,5

CTR6211



MO5414



Height 1 [mm] : 24
Height 2 [mm] : 41
Inner Diameter [mm] : 17
Outer diameter [mm] : 60

MO5809



MO6180



Height [mm] : 53
Inner Diameter [mm] : 26
Outer diameter [mm] : 82

MO6848



RE014



Length [mm] : 324
Outer thread [mm] : M12 x 1,25

RE0185



RE030



Length [mm] : 330
Outer thread 1 [mm] : M14 x 1,50
Outer thread 2 [mm] : M14 x 1,50

PICTURES

RE033



Length [mm] : 342
Outer thread [mm] : M14 x 1,50

RE046



Length [mm] : 226.5
Outer thread 1 [mm] : M14 x 1,50
Outer thread 2 [mm] : M18 x 1,50

RE049



Length [mm] : 291.5
Outer thread 1 [mm] : M17 x 1,50
Outer thread 2 [mm] : M14 x 1,50

RE053



Length [mm] : 294
Outer thread 1 [mm] : M12 x 1,25
Outer thread 2 [mm] : M16 x 1,00

RE056



Inner Thread [mm] : M14 x 1,50
Outer thread [mm] : M12 x 1,50
Overall Length [mm] : 316.2

RE071



Length [mm] : 192.5
Outer thread 1 [mm] : M14 x 1,50
Outer thread 2 [mm] : M12 x 1,25

RE1609



RE188



Outer thread 1 [mm] : M14 x 1,50
Outer thread 2 [mm] : M15 x 1,50
Overall Length [mm] : 291

RE2406



RE5192



Length [mm] : 369
Outer thread [mm] : M14 x 1,50

RE5407



Length [mm] : 292
Outer thread [mm] : M14 x 2,00

RE5438



Length [mm] : 365
Outer thread [mm] : M14 x 1,50

RE5444



Length [mm] : 260.5
Outer thread 1 [mm] : M14 x 1,50
Outer thread 2 [mm] : M16 x 1,50

RE5450



Length [mm] : 305
Outer thread [mm] : M14 x 2,00

RE5463



RE5472



Inner Thread [mm] : M14 x 1,50
Length [mm] : 255.5

RE5473



Outer thread 1 [mm] : M14 x 1,50
Outer thread 2 [mm] : M14 x 1,50
Overall Length [mm] : 355,5

RE5489



Length [mm] : 227
Outer thread 1 [mm] : M14 x 1,50
Outer thread 2 [mm] : M18 x 1,50

RE5499



Inner Thread [mm] : M14 x 1,50
Length [mm] : 318
Outer thread [mm] : M12 x 1,50

RE5512



RE5547



Length [mm] : 280
Outer thread [mm] : M14 x 1,50

RE5549



Length [mm] : 194
Outer thread 1 [mm] : M16 x 1,00
Outer thread 2 [mm] : M18 x 1,50

RE5571



RE5604



Length [mm] : 228,5
Outer thread 1 [mm] : M14 x 1,50
Outer thread 2 [mm] : M18 x 1,50

RE5651



Inner Thread [mm] : M14 x 1,50
Outer thread [mm] : M14 x 1,50
Overall Length [mm] : 319,8

RE5712



RE5718



Outer thread 1 [mm] : M14 x 1,50
Outer thread 2 [mm] : M16 x 1,50
Overall Length [mm] : 310,2

RE5782



Outer thread 1 [mm] : M14 x 1,50
Outer thread 2 [mm] : M16 x 1,50
Overall Length [mm] : 256

RE5815



Outer thread 1 [mm] : M14 x 1,50
Outer thread 2 [mm] : M12 x 1,50
Overall Length [mm] : 298

RE5841



Outer thread 1 [mm] : M16 x 1,50
Outer thread 2 [mm] : M16 x 1,50
Overall Length [mm] : 328

RE5843



Outer thread 1 [mm] : M18 x 1,50
Outer thread 2 [mm] : M14 x 1,50
Overall Length [mm] : 261,3

RE5845



Length [mm] : 262
Outer thread 1 [mm] : M16 x 1,50
Outer thread 2 [mm] : M18 x 1,50

PICTURES

RE5870



Length [mm] : 315
 Outer thread 1 [mm] : M14 x 1,50
 Outer thread 2 [mm] : M14 x 1,50

RE5902



Outer thread [mm] : M14 x 1,50
 Overall Length [mm] : 230.7
 Thread Size : M14 x 1,50

RE5908



Length [mm] : 185.5
 Outer thread 1 [mm] : M14 x 1,50
 Outer thread 2 [mm] : M12 x 1,25

RE5928



Outer thread 1 [mm] : M18 x 1,50
 Outer thread 2 [mm] : M16 x 1,50
 Overall Length [mm] : 416

RE5946



Length [mm] : 309
 Outer thread 1 [mm] : M17 x 1,50
 Outer thread 2 [mm] : M14 x 1,50

RE5948



Length [mm] : 199
 Outer thread 1 [mm] : M14 x 1,50
 Outer thread 2 [mm] : M18 x 1,50

RE5957



Outer thread 1 [mm] : M14 x 1,50
 Outer thread 2 [mm] : M15 x 1,50
 Overall Length [mm] : 249,5

RE5975



Length [mm] : 307.3
 Outer thread 1 [mm] : M16 x 1,50
 Outer thread 2 [mm] : M14 x 1,50

RE5986



Length [mm] : 211
 Outer thread 1 [mm] : M14 x 1,50
 Outer thread 2 [mm] : M12 x 1,00

RE5990



Length [mm] : 215
 Outer thread 1 [mm] : M12 x 1,25
 Outer thread 2 [mm] : M14 x 1,50

RE6055



RE6092



Outer thread 1 [mm] : M14 x 1,50
 Outer thread 2 [mm] : M14 x 1,50
 Overall Length [mm] : 312,5

RE8143



Outer thread 1 [mm] : M14 x 1,50
 Outer thread 2 [mm] : M16 x 1,50
 Overall Length [mm] : 340.5

HEAD OFFICE
JOHANNESBUR RANDBURG
TIME ACCESS AND AUTOMOTIVE SYSTEMS,
23 STEVENS ROAD, BLAIRGOWRIE, RANDBURG,
South Africa

Tel: +27(0)11 326 4146

Fax: +27(0)11 781 4392

adriang@lantic.net

www.t-a-s.co.za

www.timeandautomotive.co.za